

# Optoelectronics Designer's Catalog

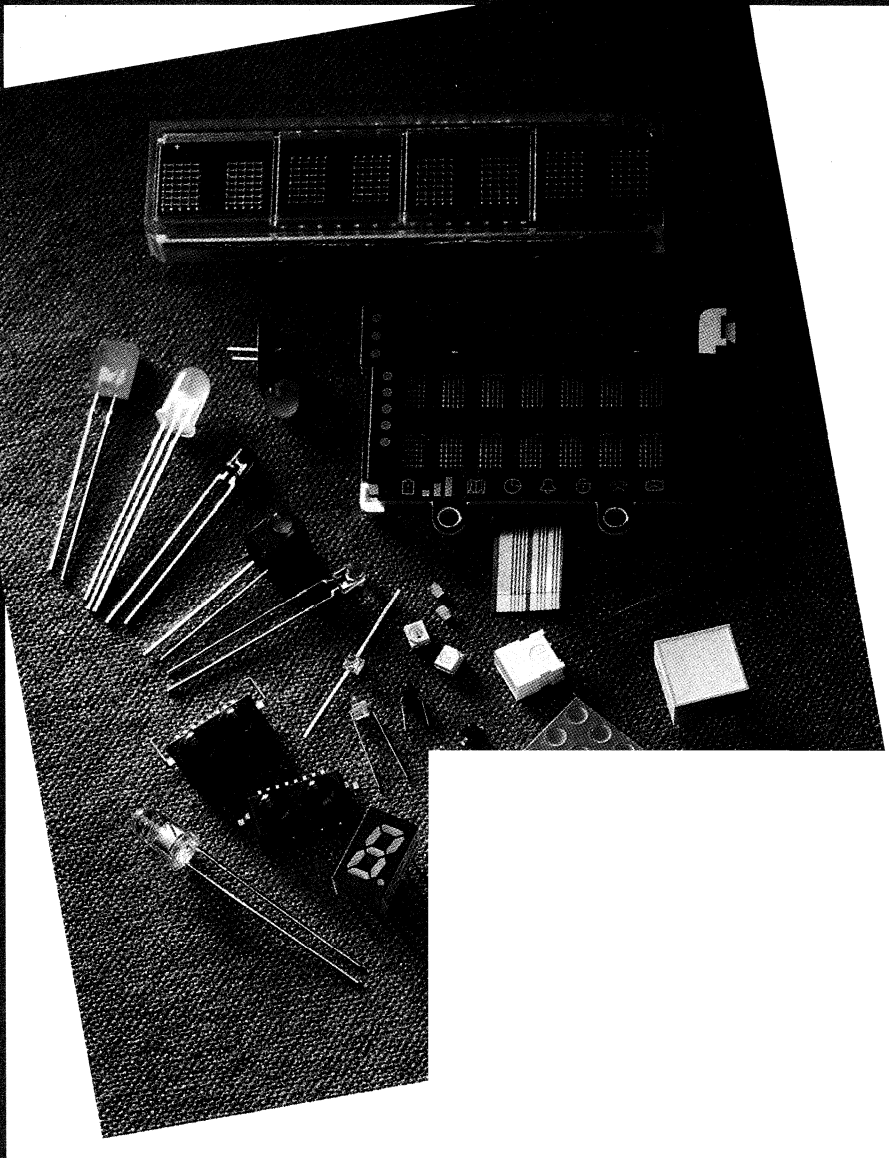





---

# Hewlett-Packard: A Leader in Components

## A Brief Sketch

Founded in 1961, and headquartered in San Jose, California, the Hewlett-Packard Company's Components Group is the world's largest independent supplier of communications components. Today the group has approximately 9500 employees, and had fiscal 1995 revenues of \$856 million.

The Components Group incorporates three major divisions—Optoelectronics, Optical Communication and Communications Components—and serves six major markets: communications, computer/office, industrial, transportation, consumer and government/military. Included in the Components Group's extensive line of more than 9,000 components are visible and infrared LED lamps; visible LED displays, light bars and arrays; Infrared Data Association (IrDA)-compliant infrared transceiver modules; fiber-optic transceivers, transmitters and receivers meeting most of today's industry standards; motion control devices; optocouplers and related optically-isolated control components; bar-code scanners; RF and microwave semiconductors; and communications amplifiers and

assemblies. HP offers the world's brightest LEDs and is a technical leader for visible III-V products.

The Components Group markets products through a sales force of 300 technically-educated sales professionals located in about 40 countries. HP components are also sold through a worldwide distributor network with more than 150 locations. Altogether, 95 percent of sales revenues are from customers external to HP.

The Components Group maintains five marketing centers worldwide in San Jose, California; Boeblingen, Germany; Tokyo, Japan; Frimley, UK; and Singapore. Each is fully staffed with product application and support engineers and each is responsible for regional decision making. A design center in Tokyo is specifically chartered to develop products for the Japanese market.

Local decision-making is central to HP's transnational business strategy which focuses on customer satisfaction. In addition to providing the right product with superior quality and reliability, the Components Group strives to ensure worldwide product availability,

accurate on-time delivery and up-to-date technical information for its customers.

## Quality and Reliability

Quality and reliability are very important concepts to Hewlett-Packard in maintaining the commitment to product performance.

At Hewlett-Packard, quality is integral to product development, manufacturing, and final introduction. HP's commitment to quality means that there is a continuous process of improvement and tightening of quality standards. Manufacturing quality circles and quality testing programs are important ingredients in HP products.

Reliability testing is also required for the introduction of new HP components. Lifespan calculations in "mean-time-between-failure" (MTBF) terms are published and available as reliability data sheets. HP's stringent reliability testing assures long component lifetimes and consistent product performance.

The body of this book is printed on recycled paper.

---

# About This Catalog

## About This Catalog

To help you choose and design with Hewlett-Packard optoelectronic components, this catalog contains detailed product specifications. The catalog is divided into four product sections:

1. LED Lamps and Indicators
2. LED Light Bars and Bar Graph Arrays
3. LED Displays
4. Infrared Products

## How to Find the Right Information

- The Table of Contents helps you locate the product sections as well as the selection guides for each product section.
- The Alphanumeric Index (p. iv) lists every component in this catalog and the page number on which the corresponding data sheet is located.

- Selection Guides at the beginning of each of the four product sections allow you to quickly select products most suitable for your application and also list the page number on which the corresponding data sheet is located.

Following the product sections is a complete listing of available application notes and briefs which can be easily obtained. The final section contains sales and service information.

## How to Order

To order any component in this catalog, call your nearest HP authorized distributor or HP sales office.

A complete listing of HP authorized distributors is located on page 6-3. These distributors can offer off-the-shelf delivery for most HP components.

## Service and Support

For technical assistance or to find out the location of your nearest HP sales office, distributor or representative call (US and Canada only): 1-800-235-0312 or 408-654-8675.

Elsewhere in the world, call your local sales office located in your telephone directory. Ask for a Components representative.

## For Additional Information

For additional technical literature not available in this catalog, try our fax-back service (US and Canada only) at: 1-800-450-9455.

Elsewhere in the world, call your local HP sales office located in your telephone directory. Ask for a Components representative.

Information regarding Hewlett-Packard Components Group products is available on the World Wide Web via the Hewlett-Packard home page at: <http://www.hp.com/> or directly at: <http://www.hp.com/go/components/>

---

# Table of Contents

---

<b>Alphanumeric Index</b> .....	iv
<b>LED Lamps and Indicators</b> .....	1-1
Introduction .....	1-2
Selection Guide .....	1-4
<b>LED Light Bars and Bar Graph Arrays</b> .....	2-1
Introduction .....	2-2
Selection Guide .....	2-3
<b>LED Displays</b> .....	3-1
Introduction .....	3-2
Selection Guide .....	3-3
<b>LED Glass/Ceramic Displays</b> .....	3-207
Introduction .....	3-208
Selection Guide .....	3-209
<b>Infrared Products</b> .....	4-1
Introduction .....	4-2
Selection Guide .....	4-3
Design Guide .....	4-4
<b>Applications</b> .....	5-1
<b>Sales and Service</b> .....	6-1
Ordering Information, After-Sales Service .....	6-2
Authorized Distributor & Representative List .....	6-3

---

# Alphanumeric Index

---

HCMS-2000 .....	3-156	HCMS-2712 .....	3-100
HCMS-2001 .....	3-156	HCMS-2713 .....	3-100
HCMS-2002 .....	3-156	HCMS-2714 .....	3-100
HCMS-2003 .....	3-156	HCMS-2720 .....	3-100
HCMS-2004 .....	3-156	HCMS-2721 .....	3-100
HCMS-2010 .....	3-240	HCMS-2722 .....	3-100
HCMS-2011 .....	3-240	HCMS-2723 .....	3-100
HCMS-2012 .....	3-240	HCMS-2724 .....	3-100
HCMS-2013 .....	3-240	HCMS-2901 .....	3-109
HCMS-2300 .....	3-156	HCMS-2902 .....	3-109
HCMS-2301 .....	3-156	HCMS-2903 .....	3-109
HCMS-2302 .....	3-156	HCMS-2904 .....	3-109
HCMS-2303 .....	3-156	HCMS-2905 .....	3-109
HCMS-2304 .....	3-156	HCMS-2911 .....	3-109
HCMS-2310 .....	3-240	HCMS-2912 .....	3-109
HCMS-2311 .....	3-240	HCMS-2913 .....	3-109
HCMS-2312 .....	3-240	HCMS-2914 .....	3-109
HCMS-2313 .....	3-240	HCMS-2915 .....	3-109
HCMS-2314 .....	3-240	HCMS-2921 .....	3-109
HCMS-2351 .....	3-240	HCMS-2922 .....	3-109
HCMS-2352 .....	3-240	HCMS-2923 .....	3-109
HCMS-2353 .....	3-240	HCMS-2924 .....	3-109
HCMS-2354 .....	3-240	HCMS-2925 .....	3-109
HCMS-2700 .....	3-100	HCMS-2961 .....	3-109
HCMS-2701 .....	3-100	HCMS-2962 .....	3-109
HCMS-2702 .....	3-100	HCMS-2963 .....	3-109
HCMS-2703 .....	3-100	HCMS-2964 .....	3-109
HCMS-2704 .....	3-100	HCMS-2965 .....	3-109
HCMS-2710 .....	3-100	HCMS-2971 .....	3-109
HCMS-2711 .....	3-100	HCMS-2972 .....	3-109

**Bold** = New Product

Note: Standard Options Available (see page xiv).

HCMS-2973 .....	3-109	HDSP-2112 .....	3-140
HCMS-2974 .....	3-109	HDSP-2113 .....	3-140
HCMS-2975 .....	3-109	HDSP-2131 .....	3-224
HDLA-2416 .....	3-164	HDSP-2132 .....	3-224
HDLG-2416 .....	3-164	HDSP-2133 .....	3-224
HDLO-2416 .....	3-164	HDSP-2179 .....	3-224
HDLR-2416 .....	3-164	HDSP-2310 .....	3-211
HDLS-2416 .....	3-164	HDSP-2311 .....	3-211
HDLU-2416 .....	3-164	HDSP-2312 .....	3-211
HDLY-2416 .....	3-164	HDSP-2313 .....	3-210
HDSP-0760 .....	3-193	HDSP-2351 .....	3-210
HDSP-0761 .....	3-193	HDSP-2352 .....	3-210
HDSP-0762 .....	3-193	HDSP-2353 .....	3-210
HDSP-0763 .....	3-193	HDSP-2450 .....	3-211
HDSP-0770 .....	3-193	HDSP-2451 .....	3-211
HDSP-0771 .....	3-193	HDSP-2452 .....	3-211
HDSP-0772 .....	3-193	HDSP-2453 .....	3-211
HDSP-0781 .....	3-256	HDSP-2490 .....	3-15
HDSP-0782 .....	3-256	HDSP-2491 .....	3-15
HDSP-0783 .....	3-256	HDSP-2492 .....	3-15
HDSP-0784 .....	3-256	HDSP-2493 .....	3-15
HDSP-0791 .....	3-256	HDSP-2500 .....	3-140
HDSP-0792 .....	3-256	HDSP-2501 .....	3-140
HDSP-0793 .....	3-256	HDSP-2502 .....	3-140
HDSP-0794 .....	3-256	HDSP-2503 .....	3-140
HDSP-0860 .....	3-193	HDSP-2530 .....	3-125
HDSP-0861 .....	3-193	HDSP-2531 .....	3-125
HDSP-0862 .....	3-193	HDSP-2532 .....	3-125
HDSP-0863 .....	3-193	HDSP-2533 .....	3-125
HDSP-0881 .....	3-256	HDSP-2534 .....	3-125
HDSP-0882 .....	3-256	HDSP-3350 .....	3-28
HDSP-0883 .....	3-256	HDSP-3351 .....	3-28
HDSP-0884 .....	3-256	HDSP-3353 .....	3-28
HDSP-0960 .....	3-193	HDSP-3356 .....	3-28
HDSP-0961 .....	3-193	HDSP-3400 .....	3-92
HDSP-0962 .....	3-193	HDSP-3401 .....	3-92
HDSP-0963 .....	3-193	HDSP-3403 .....	3-92
HDSP-0981 .....	3-256	HDSP-3405 .....	3-92
HDSP-0982 .....	3-256	HDSP-3406 .....	3-92
HDSP-0983 .....	3-256	HDSP-3530 .....	3-42
HDSP-0984 .....	3-256	HDSP-3531 .....	3-42
HDSP-2010 .....	3-211	HDSP-3533 .....	3-42
HDSP-2107 .....	3-140	HDSP-3536 .....	3-42
HDSP-2110 .....	3-140	HDSP-3600 .....	3-50
HDSP-2111 .....	3-140	HDSP-3601 .....	3-50

**Bold** = New Product

Note: Standard Options Available (see page xiv).

HDSP-3603 .....	3-50	HDSP-5308 .....	3-84
HDSP-3606 .....	3-50	HDSP-5321 .....	3-84
HDSP-3730 .....	3-42	HDSP-5323 .....	3-84
HDSP-3731 .....	3-42	HDSP-5401 .....	3-200
HDSP-3733 .....	3-42	HDSP-5403 .....	3-200
HDSP-3736 .....	3-42	HDSP-5501 .....	3-84
HDSP-3900 .....	3-92	HDSP-5503 .....	3-84
HDSP-3901 .....	3-92	HDSP-5507 .....	3-84
HDSP-3903 .....	3-92	HDSP-5508 .....	3-84
HDSP-3905 .....	3-92	HDSP-5521 .....	3-84
HDSP-3906 .....	3-92	HDSP-5523 .....	3-84
HDSP-4030 .....	3-42	HDSP-5531 .....	3-42
HDSP-4031 .....	3-42	HDSP-5533 .....	3-42
HDSP-4033 .....	3-42	HDSP-5537 .....	3-42
HDSP-4036 .....	3-42	HDSP-5538 .....	3-42
HDSP-4130 .....	3-42	HDSP-5551 .....	3-28
HDSP-4131 .....	3-42	HDSP-5553 .....	3-28
HDSP-4133 .....	3-42	HDSP-5557 .....	3-28
HDSP-4136 .....	3-42	HDSP-5558 .....	3-28
HDSP-4200 .....	3-92	HDSP-5601 .....	3-84
HDSP-4201 .....	3-92	HDSP-5603 .....	3-84
HDSP-4203 .....	3-92	HDSP-5607 .....	3-84
HDSP-4205 .....	3-92	HDSP-5608 .....	3-84
HDSP-4206 .....	3-92	HDSP-5621 .....	3-84
HDSP-4401 .....	3-200	HDSP-5623 .....	3-84
HDSP-4403 .....	3-200	HDSP-5701 .....	3-84
HDSP-4501 .....	3-200	HDSP-5703 .....	3-84
HDSP-4503 .....	3-200	HDSP-5707 .....	3-84
HDSP-4600 .....	3-50	HDSP-5708 .....	3-84
HDSP-4601 .....	3-50	HDSP-5721 .....	3-84
HDSP-4603 .....	3-50	HDSP-5723 .....	3-84
HDSP-4606 .....	3-50	HDSP-5731 .....	3-42
HDSP-4701 .....	3-200	HDSP-5733 .....	3-42
HDSP-4703 .....	3-200	HDSP-5737 .....	3-42
HDSP-4820 .....	2-23	HDSP-5738 .....	3-42
HDSP-4830 .....	2-23	HDSP-6650 .....	3-213
HDSP-4832 .....	2-23	HDSP-6651 .....	3-213
HDSP-4836 .....	2-23	HDSP-6652 .....	3-213
HDSP-4840 .....	2-23	HDSP-6653 .....	3-213
HDSP-4850 .....	2-23	HDSP-7301 .....	3-66
HDSP-5101 .....	3-200	HDSP-7302 .....	3-66
HDSP-5103 .....	3-200	HDSP-7303 .....	3-66
HDSP-5301 .....	3-84	HDSP-7304 .....	3-66
HDSP-5303 .....	3-84	HDSP-7307 .....	3-66
HDSP-5307 .....	3-84	HDSP-7308 .....	3-66

**Bold** = New Product

Note: Standard Options Available (see page xiv).

HDSP-7401 .....	3-66	HDSP-A807 .....	3-28
HDSP-7402 .....	3-66	HDSP-A808 .....	3-28
HDSP-7403 .....	3-66	HDSP-A901 .....	3-28
HDSP-7404 .....	3-66	HDSP-A903 .....	3-28
HDSP-7407 .....	3-66	HDSP-A907 .....	3-28
HDSP-7408 .....	3-66	HDSP-A908 .....	3-28
HDSP-7501 .....	3-66	HDSP-E100 .....	3-28
HDSP-7502 .....	3-66	HDSP-E101 .....	3-28
HDSP-7503 .....	3-66	HDSP-E103 .....	3-28
HDSP-7504 .....	3-66	HDSP-E108 .....	3-28
HDSP-7507 .....	3-66	HDSP-E150 .....	3-50
HDSP-7508 .....	3-66	HDSP-E151 .....	3-50
HDSP-7511 .....	3-28	HDSP-E153 .....	3-50
HDSP-7513 .....	3-28	HDSP-E156 .....	3-50
HDSP-7517 .....	3-28	HDSP-F001 .....	3-74
HDSP-7518 .....	3-28	HDSP-F003 .....	3-74
HDSP-7801 .....	3-66	HDSP-F007 .....	3-74
HDSP-7802 .....	3-66	HDSP-F008 .....	3-74
HDSP-7803 .....	3-66	HDSP-F011 .....	3-18
HDSP-7804 .....	3-66	HDSP-F013 .....	3-18
HDSP-7807 .....	3-66	HDSP-F101 .....	3-28
HDSP-7808 .....	3-66	HDSP-F103 .....	3-28
HDSP-8600 .....	3-92	HDSP-F107 .....	3-28
HDSP-8601 .....	3-92	HDSP-F108 .....	3-28
HDSP-8603 .....	3-92	HDSP-F111 .....	3-18
HDSP-8605 .....	3-92	HDSP-F113 .....	3-18
HDSP-8606 .....	3-92	HDSP-F151 .....	3-74
HDSP-A011 .....	3-18	HDSP-F153 .....	3-74
HDSP-A013 .....	3-18	HDSP-F157 .....	3-74
HDSP-A101 .....	3-28	HDSP-F158 .....	3-74
HDSP-A103 .....	3-28	HDSP-F161 .....	3-18
HDSP-A107 .....	3-28	HDSP-F163 .....	3-18
HDSP-A108 .....	3-28	HDSP-F201 .....	3-74
HDSP-A111 .....	3-18	HDSP-F203 .....	3-74
HDSP-A113 .....	3-18	HDSP-F207 .....	3-74
HDSP-A151 .....	3-66	HDSP-F208 .....	3-74
HDSP-A153 .....	3-66	HDSP-F211 .....	3-18
HDSP-A157 .....	3-66	HDSP-F213 .....	3-18
HDSP-A158 .....	3-66	HDSP-F301 .....	3-74
HDSP-A211 .....	3-18	HDSP-F303 .....	3-74
HDSP-A213 .....	3-18	HDSP-F307 .....	3-74
HDSP-A511 .....	3-18	HDSP-F308 .....	3-74
HDSP-A513 .....	3-18	HDSP-F401 .....	3-74
HDSP-A801 .....	3-28	HDSP-F403 .....	3-74
HDSP-A803 .....	3-28	HDSP-F407 .....	3-74

**Bold** = New Product

Note: Standard Options Available (see page xiv).

HDSP-F408 .....	3-74	HDSP-H211 .....	3-18
HDSP-F501 .....	3-74	HDSP-H213 .....	3-18
HDSP-F503 .....	3-74	HDSP-H511 .....	3-18
HDSP-F507 .....	3-74	HDSP-H513 .....	3-18
HDSP-F508 .....	3-74	HDSP-K011 .....	3-18
HDSP-F511 .....	3-18	HDSP-K013 .....	3-18
HDSP-F513 .....	3-18	HDSP-K111 .....	3-18
HDSP-G001 .....	3-74	HDSP-K113 .....	3-18
HDSP-G003 .....	3-74	HDSP-K121 .....	3-28
HDSP-G011 .....	3-18	HDSP-K123 .....	3-28
HDSP-G013 .....	3-18	HDSP-K211 .....	3-18
HDSP-G101 .....	3-28	HDSP-K213 .....	3-18
HDSP-G103 .....	3-28	HDSP-K511 .....	3-18
HDSP-G111 .....	3-18	HDSP-K513 .....	3-18
HDSP-G113 .....	3-18	HDSP-K701 .....	3-28
HDSP-G151 .....	3-74	HDSP-K703 .....	3-28
HDSP-G153 .....	3-74	HDSP-L101 .....	3-200
HDSP-G161 .....	3-18	HDSP-L103 .....	3-200
HDSP-G163 .....	3-18	HDSP-L201 .....	3-200
HDSP-G201 .....	3-74	HDSP-M101 .....	3-200
HDSP-G203 .....	3-74	HDSP-M103 .....	3-200
HDSP-G211 .....	3-18	HDSP-N100 .....	3-28
HDSP-G213 .....	3-18	HDSP-N101 .....	3-28
HDSP-G301 .....	3-74	HDSP-N103 .....	3-28
HDSP-G303 .....	3-74	HDSP-N105 .....	3-28
HDSP-G401 .....	3-74	HDSP-N106 .....	3-28
HDSP-G403 .....	3-74	HDSP-N150 .....	3-92
HDSP-G501 .....	3-74	HDSP-N151 .....	3-92
HDSP-G503 .....	3-74	HDSP-N153 .....	3-92
HDSP-G511 .....	3-18	HDSP-N155 .....	3-92
HDSP-G513 .....	3-18	HDSP-N156 .....	3-92
HDSP-H011 .....	3-18	HDSP-U001 .....	3-58
HDSP-H013 .....	3-18	HDSP-U003 .....	3-58
HDSP-H101 .....	3-28	HDSP-U011 .....	3-58
HDSP-H103 .....	3-28	HDSP-U013 .....	3-58
HDSP-H107 .....	3-28	HDSP-U101 .....	3-58
HDSP-H108 .....	3-28	HDSP-U103 .....	3-58
HDSP-H111 .....	3-18	HDSP-U111 .....	3-58
HDSP-H113 .....	3-18	HDSP-U113 .....	3-58
HDSP-H151 .....	3-84	HDSP-U201 .....	3-58
HDSP-H153 .....	3-84	HDSP-U203 .....	3-58
HDSP-H157 .....	3-84	HDSP-U211 .....	3-58
HDSP-H158 .....	3-84	HDSP-U213 .....	3-58
HDSP-H161 .....	3-18	HDSP-U301 .....	3-58
HDSP-H163 .....	3-18	HDSP-U303 .....	3-58

**Bold** = New Product

Note: Standard Options Available (see page xiv).



HDSP-U311 .....	3-58	<b>HLMA-GH20</b> .....	1-31
HDSP-U313 .....	3-58	<b>HLMA-GH22</b> .....	1-31
HDSP-U401 .....	3-58	<b>HLMA-GJ15</b> .....	1-31
HDSP-U403 .....	3-58	<b>HLMA-GJ17</b> .....	1-31
HDSP-U411 .....	3-58	<b>HLMA-GL15</b> .....	1-31
HDSP-U413 .....	3-58	<b>HLMA-GL17</b> .....	1-31
HDSP-U501 .....	3-58	<b>HLMA-GL20</b> .....	1-31
HDSP-U503 .....	3-58	<b>HLMA-GL22</b> .....	1-31
HDSP-U511 .....	3-58	HLMA-KH00 .....	1-37
HDSP-U513 .....	3-58	HLMA-KL00 .....	1-37
HEMT-1001 .....	1-24	<b>HLMA-PH00</b> .....	1-161
HEMT-3301 .....	1-24	<b>HLMA-PL00</b> .....	1-161
HEMT-6000 .....	1-24	<b>HLMA-QH00</b> .....	1-161
HLCP-A100 .....	2-8	<b>HLMA-QL00</b> .....	1-161
HLCP-B100 .....	2-8	HLMP-0104 .....	1-122
HLCP-C100 .....	2-8	HLMP-0300 .....	1-149
HLCP-D100 .....	2-8	HLMP-0301 .....	1-149
HLCP-E100 .....	2-8	HLMP-0400 .....	1-149
HLCP-F100 .....	2-8	HLMP-0401 .....	1-149
HLCP-G100 .....	2-8	HLMP-0503 .....	1-149
HLCP-H100 .....	2-8	HLMP-0504 .....	1-149
HLCP-J100 .....	2-23	HLMP-0800 .....	1-157
HLMA-CH00 .....	1-37	HLMP-1300 .....	1-134
<b>HLMA-CG15</b> .....	1-31	HLMP-1301 .....	1-134
<b>HLMA-CG17</b> .....	1-31	HLMP-1302 .....	1-134
<b>HLMA-CH15</b> .....	1-31	HLMP-1320 .....	1-128
<b>HLMA-CH17</b> .....	1-31	HLMP-1321 .....	1-128
<b>HLMA-CH20</b> .....	1-31	HLMP-1340 .....	1-83
<b>HLMA-CH22</b> .....	1-31	HLMP-1385 .....	1-134
<b>HLMA-CJ15</b> .....	1-31	HLMP-1400 .....	1-134
<b>HLMA-CJ17</b> .....	1-31	HLMP-1401 .....	1-134
HLMA-CL00 .....	1-37	HLMP-1402 .....	1-134
<b>HLMA-CL15</b> .....	1-31	HLMP-1420 .....	1-128
<b>HLMA-CL17</b> .....	1-31	HLMP-1421 .....	1-128
<b>HLMA-CL20</b> .....	1-31	HLMP-1440 .....	1-83
<b>HLMA-CL22</b> .....	1-31	HLMP-1485 .....	1-134
HLMA-DG00 .....	1-37	HLMP-1503 .....	1-134
HLMA-DH00 .....	1-37	HLMP-1520 .....	1-128
<b>HLMA-DH05</b> .....	1-49	HLMP-1521 .....	1-128
HLMA-DL00 .....	1-37	HLMP-1523 .....	1-134
<b>HLMA-DL05</b> .....	1-49	HLMP-1540 .....	1-83
<b>HLMA-GG15</b> .....	1-31	HLMP-1585 .....	1-134
<b>HLMA-GG17</b> .....	1-31	HLMP-1600 .....	1-113
<b>HLMA-GH15</b> .....	1-31	HLMP-1601 .....	1-113
<b>HLMA-GH17</b> .....	1-31	HLMP-1620 .....	1-113

**Bold** = New Product

Note: Standard Options Available (see page xiv).

HLMP-1621 .....	1-113	HLMP-3400 .....	1-94
HLMP-1640 .....	1-113	HLMP-3401 .....	1-94
HLMP-1641 .....	1-113	HLMP-3415 .....	1-88
HLMP-1700 .....	1-108	HLMP-3416 .....	1-88
HLMP-1719 .....	1-108	HLMP-3450 .....	1-101
HLMP-1790 .....	1-108	HLMP-3451 .....	1-101
HLMP-2300 .....	2-8	HLMP-3465 .....	1-101
HLMP-2350 .....	2-8	HLMP-3466 .....	1-101
HLMP-2400 .....	2-8	HLMP-3490 .....	1-83
HLMP-2450 .....	2-8	HLMP-3502 .....	1-94
HLMP-2500 .....	2-8	HLMP-3507 .....	1-94
HLMP-2550 .....	2-8	HLMP-3517 .....	1-88
HLMP-2598 .....	2-30	HLMP-3519 .....	1-88
HLMP-2599 .....	2-30	HLMP-3553 .....	1-101
HLMP-2600 .....	2-8	HLMP-3554 .....	1-101
HLMP-2620 .....	2-8	HLMP-3567 .....	1-101
HLMP-2635 .....	2-8	HLMP-3568 .....	1-101
HLMP-2655 .....	2-8	HLMP-3590 .....	1-83
HLMP-2670 .....	2-8	HLMP-3600 .....	1-113
HLMP-2685 .....	2-8	HLMP-3601 .....	1-113
HLMP-2700 .....	2-8	HLMP-3650 .....	1-113
HLMP-2720 .....	2-8	HLMP-3651 .....	1-113
HLMP-2735 .....	2-8	HLMP-3680 .....	1-113
HLMP-2755 .....	2-8	HLMP-3681 .....	1-113
HLMP-2770 .....	2-8	HLMP-3750 .....	1-83
HLMP-2785 .....	2-8	HLMP-3762 .....	1-94
HLMP-2800 .....	2-8	HLMP-3850 .....	1-83
HLMP-2820 .....	2-8	HLMP-3862 .....	1-94
HLMP-2835 .....	2-8	HLMP-3950 .....	1-83
HLMP-2855 .....	2-8	HLMP-3962 .....	1-94
HLMP-2870 .....	2-8	HLMP-4000 .....	1-157
HLMP-2885 .....	2-8	HLMP-4100 .....	1-8
HLMP-2898 .....	2-30	HLMP-4101 .....	1-8
HLMP-2899 .....	2-30	HLMP-4700 .....	1-108
HLMP-2950 .....	2-8	HLMP-4719 .....	1-108
HLMP-2965 .....	2-8	HLMP-4740 .....	1-108
HLMP-3300 .....	1-94	HLMP-5029 .....	1-120
HLMP-3301 .....	1-94	HLMP-6000 .....	1-174
HLMP-3315 .....	1-88	HLMP-6001 .....	1-174
HLMP-3316 .....	1-88	HLMP-6203 .....	1-174
HLMP-3350 .....	1-101	HLMP-6204 .....	1-174
HLMP-3351 .....	1-101	HLMP-6205 .....	1-174
HLMP-3365 .....	1-101	HLMP-6206 .....	1-174
HLMP-3366 .....	1-101	HLMP-6208 .....	1-174
HLMP-3390 .....	1-83	HLMP-6300 .....	1-174

**Bold** = New Product

Note: Standard Options Available (see page xiv).

HLMP-6305 .....	1-174	HLMP-D101 .....	1-66
HLMP-6400 .....	1-174	HLMP-D105 .....	1-66
HLMP-6405 .....	1-174	<b>HLMP-D115</b> .....	1-49
HLMP-6500 .....	1-174	<b>HLMP-D120</b> .....	1-49
HLMP-6505 .....	1-174	HLMP-D150 .....	1-71
HLMP-6600 .....	1-174	HLMP-D155 .....	1-71
HLMP-6620 .....	1-174	HLMP-D400 .....	1-94
HLMP-6653 .....	1-174	HLMP-D401 .....	1-94
HLMP-6654 .....	1-174	HLMP-D600 .....	1-94
HLMP-6655 .....	1-174	HLMP-D640 .....	1-83
HLMP-6656 .....	1-174	HLMP-DB00 .....	1-62
HLMP-6658 .....	1-174	HLMP-DB15 .....	1-62
HLMP-6700 .....	1-174	<b>HLMP-J100</b> .....	1-124
HLMP-6720 .....	1-174	<b>HLMP-J105</b> .....	1-124
HLMP-6753 .....	1-174	<b>HLMP-J150</b> .....	1-124
HLMP-6754 .....	1-174	<b>HLMP-J155</b> .....	1-124
HLMP-6755 .....	1-174	HLMP-K101 .....	1-66
HLMP-6756 .....	1-174	HLMP-K105 .....	1-66
HLMP-6758 .....	1-174	HLMP-K150 .....	1-71
HLMP-6800 .....	1-174	HLMP-K155 .....	1-71
HLMP-6820 .....	1-174	HLMP-K400 .....	1-134
HLMP-6853 .....	1-174	HLMP-K401 .....	1-134
HLMP-6854 .....	1-174	HLMP-K402 .....	1-134
HLMP-6855 .....	1-174	HLMP-K600 .....	1-134
HLMP-6856 .....	1-174	HLMP-K640 .....	1-83
HLMP-6858 .....	1-174	<b>HLMP-P102</b> .....	1-174
HLMP-7000 .....	1-174	HLMP-P105 .....	1-174
HLMP-7019 .....	1-174	<b>HLMP-P106</b> .....	1-168
HLMP-7040 .....	1-174	<b>HLMP-P156</b> .....	1-168
HLMP-8100 .....	1-44	<b>HLMP-P202</b> .....	1-174
HLMP-8102 .....	1-44	HLMP-P205 .....	1-174
HLMP-8103 .....	1-44	<b>HLMP-P302</b> .....	1-174
HLMP-8109 .....	1-75	HLMP-P305 .....	1-174
HLMP-8115 .....	1-75	<b>HLMP-P402</b> .....	1-174
HLMP-8205 .....	1-75	HLMP-P405 .....	1-174
HLMP-8209 .....	1-75	<b>HLMP-P502</b> .....	1-174
HLMP-8305 .....	1-75	HLMP-P505 .....	1-174
HLMP-8309 .....	1-75	HLMP-P605 .....	1-174
HLMP-8405 .....	1-75	HLMP-Q101 .....	1-174
HLMP-8409 .....	1-75	HLMP-Q105 .....	1-174
HLMP-8505 .....	1-75	<b>HLMP-Q102</b> .....	1-168
HLMP-8509 .....	1-75	<b>HLMP-Q106</b> .....	1-168
HLMP-8605 .....	1-75	HLMP-Q150 .....	1-174
HLMP-C100 .....	1-44	<b>HLMP-Q152</b> .....	1-168
HLMP-C110 .....	1-44	HLMP-Q155 .....	1-174

**Bold** = New Product

Note: Standard Options Available (see page xiv).

<b>HLMP-Q156</b> .....	1-168	<b>HSDL-4220</b> .....	4-48
HLMP-Q400 .....	1-174	<b>HSDL-4230</b> .....	4-48
HLMP-Q600 .....	1-174	<b>HSDL-4400</b> .....	4-68
HLMP-R100 .....	1-149	<b>HSDL-4420</b> .....	4-68
HLMP-S100 .....	1-153	<b>HSDL-5400</b> .....	4-68
HLMP-S200 .....	1-153	<b>HSDL-5420</b> .....	4-68
HLMP-S201 .....	1-153	<b>HSDL-7000</b> .....	4-43
HLMP-S300 .....	1-153	<b>HSDL-8000</b> .....	4-3
HLMP-S301 .....	1-153	<b>HSMA-T425</b> .....	1-199
HLMP-S400 .....	1-153	<b>HSMA-T525</b> .....	1-199
HLMP-S401 .....	1-153	<b>HSMA-T625</b> .....	1-199
HLMP-S500 .....	1-153	<b>HSMA-T725</b> .....	1-199
HLMP-S501 .....	1-153	HSMD-C650 .....	1-212
HLMP-S600 .....	1-153	HSMD-C670 .....	1-212
HLMP-T200 .....	2-19	HSMD-T400 .....	1-204
HLMP-T300 .....	2-19	<b>HSMD-T425</b> .....	1-199
HLMP-T400 .....	2-19	HSMD-T500 .....	1-204
HLMP-T500 .....	2-19	<b>HSMD-T525</b> .....	1-199
<b>HLMP-V100</b> .....	1-56	HSMD-T600 .....	1-204
<b>HLMP-V500</b> .....	1-56	<b>HSMD-T625</b> .....	1-199
<b>HLMP-VH00</b> .....	1-56	HSMD-T700 .....	1-204
<b>HLMP-VL00</b> .....	1-56	<b>HSMD-T725</b> .....	1-199
<b>HLMT-CL00</b> .....	1-37	<b>HSME-T400</b> .....	1-204
<b>HLMT-CH00</b> .....	1-37	<b>HSME-T500</b> .....	1-204
<b>HLMT-DL00</b> .....	1-37	<b>HSME-T600</b> .....	1-204
<b>HLMT-DH00</b> .....	1-37	<b>HSME-T700</b> .....	1-204
<b>HLMT-PH00</b> .....	1-161	HSMF-C655 .....	1-212
<b>HLMT-PL00</b> .....	1-161	HSMG-C650 .....	1-212
<b>HLMT-QH00</b> .....	1-161	HSMG-C670 .....	1-212
<b>HLMT-QL00</b> .....	1-161	HSMG-T400 .....	1-204
HMDL-2416 .....	3-209	HSMG-T500 .....	1-204
HPDL-1414 .....	3-175	HSMG-T600 .....	1-204
HPDL-2416 .....	3-175	HSMG-T700 .....	1-204
<b>HPWA-DH00</b> .....	1-25	HSMH-C650 .....	1-212
<b>HPWA-DL00</b> .....	1-25	HSMH-C670 .....	1-212
<b>HPWA-MH00</b> .....	1-25	HSMH-T400 .....	1-204
<b>HPWA-ML00</b> .....	1-25	HSMH-T500 .....	1-204
<b>HPWR-M300</b> .....	1-25	HSMH-T600 .....	1-204
<b>HLWT-DH00</b> .....	1-25	HSMH-T700 .....	1-204
<b>HPWT-DL00</b> .....	1-25	<b>HSMJ-T425</b> .....	1-199
<b>HPWT-MH00</b> .....	1-25	<b>HSMJ-T525</b> .....	1-199
<b>HPWT-ML00</b> .....	1-25	<b>HSMJ-T625</b> .....	1-199
<b>HSDL-1000</b> .....	4-33	<b>HSMJ-T725</b> .....	1-199
<b>HSDL-1001</b> .....	4-53	HSMS-C650 .....	1-212
<b>HSDL-1100</b> .....	4-61	HSMS-C670 .....	1-212

**Bold** = New Product

Note: Standard Options Available (see page xiv).

HSMS-T400 .....	1-204	5082-7626 .....	3-50
HSMS-T500 .....	1-204	5082-7650 .....	3-50
HSMS-T600 .....	1-204	5082-7651 .....	3-50
HSMS-T700 .....	1-204	5082-7653 .....	3-50
HSMY-C650 .....	1-212	5082-7656 .....	3-50
HSMY-C670 .....	1-212	5082-7660 .....	3-50
HSMY-T400 .....	1-204	5082-7661 .....	3-50
HSMY-T500 .....	1-204	5082-7663 .....	3-50
HSMY-T600 .....	1-204	5082-7666 .....	3-50
HSMY-T700 .....	1-204	5082-7730 .....	3-50
4N51 .....	3-249	5082-7731 .....	3-50
4N52 .....	3-249	5082-7736 .....	3-50
4N53 .....	3-249	5082-7740 .....	3-50
4N54 .....	3-249	5082-7750 .....	3-50
5082-7300 .....	3-187	5082-7751 .....	3-50
5082-7302 .....	3-187	5082-7756 .....	3-50
5082-7304 .....	3-187	5082-7760 .....	3-50
5082-7340 .....	3-187		
5082-7610 .....	3-50		
5082-7611 .....	3-50		
5082-7613 .....	3-50		
5082-7616 .....	3-50		
5082-7620 .....	3-50		
5082-7621 .....	3-50		
5082-7623 .....	3-50		

**Bold** = New Product

Note: Standard Options Available (see page xiv).

### **Solid State Display Intensity and Color Selections**

Option S01	Intensity and Color Selected Displays .....	3-13
Option S02	Intensity and Color Selected Displays .....	3-13
Option S20	Intensity and Color Selected Displays .....	3-13

### **Lead Bend Options, Subminiature Lamps**

Option 011	Tape and Reel, 1500 Lamps per Reel .....	1-188
Option 012	Gull Wing Array, Bulk Packaging .....	1-188
Option 013	Gull Wing Array, Shipping Tube .....	1-188
Option 021	Yoke Lead, Tape and Reel, 1500 Lamps per Reel .....	1-188
Option 022	Yoke Lead, Bulk Packaging .....	1-188
Option 031	Z-Bend, Tape and Reel, 1500 Lamps per Reel .....	1-188
Option 032	Z-Bend, Bulk Packaging .....	1-188
Option 1L1	2.54 mm (0.100 in) Rt. Angle Bend, Long Leads .....	1-188
Option 1S1	2.54 mm (0.100 in) Rt. Angle Bend, Short Leads .....	1-188
Option 2L1	5.08 mm (0.200 in) Rt. Angle Bend, Long Leads .....	1-188
Option 2S1	5.08 mm (0.200 in) Rt. Angle Bend, Short Leads .....	1-188

### **Luminous Intensity and Color Binning Options**

Option S02	This option provides the selection of lamps from two adjacent luminous intensity categories .....	1-219
Option S20	Devices selected to two color bin categories .....	1-219
Option S22	Devices selected to two IV categories and two color bin categories .....	1-219

### **Right Angle and Panel Mount Options**

Option 102	T-1 Rt. Angle, 2 Element Array .....	1-147
------------	--------------------------------------	-------

Option 103	T-1 Rt. Angle, 3 Element Array .....	1-147
Option 104	T-1 Rt. Angle, 4 Element Array .....	1-147
Option 105	T-1 Rt. Angle, 5 Element Array .....	1-147
Option 106	T-1 Rt. Angle, 6 Element Array .....	1-147
Option 107	T-1 Rt. Angle, 7 Element Array .....	1-147
Option 108	T-1 Rt. Angle, 8 Element Array .....	1-147

### **Panel Mount Options**

Option 007	High Profile T-1 <sup>3/4</sup> w/HLMP-0104 Clip & Ring .....	1-122
Option 010	T-1 <sup>3/4</sup> Rt. Angle, Leads Sheared Even .....	1-118
Option 100	T-1 <sup>3/4</sup> Rt. Angle, Leads Unsheared Uneven .....	1-118
Option 101	T-1 Rt. Angle, Leads Sheared Even .....	1-145
Option 010	T-1 Rt. Angle, Leads Unsheared Uneven .....	1-145
Option 010	Subminiature Rt. Angle .....	1-197

### **Tape and Reel Options**

Option 001	T-1 <sup>3/4</sup> , 5 mm (0.197 in) Formed Leads, 1300 Lamps per Reel .....	1-140
Option 001	T-1, 5 mm (0.197 in) Formed Leads, 1800 Lamps per Reel .....	1-140
Option 002	T-1 <sup>3/4</sup> , 5mm (0.197 in) Formed Leads, 1300 Lamps per Reel .....	1-140
Option 002	T-1, 5mm (0.197 in) Formed Leads, 1800 Lamps per Reel .....	1-140

### **LED Light Bars Standard Options**

Option S02	Devices Selected to Two (2) Iv Categories .....	2-33
Option S22	Devices Selected to Two (2) Iv Categories and Two (2) Color Bin Categories .....	2-33

# LED Lamps and Indicators

- **AllInGaP Lamps**
- **AlGaAs Lamps**
- **General Purpose Lamps**
- **Special Purpose Lamps**
- **Standard Options**

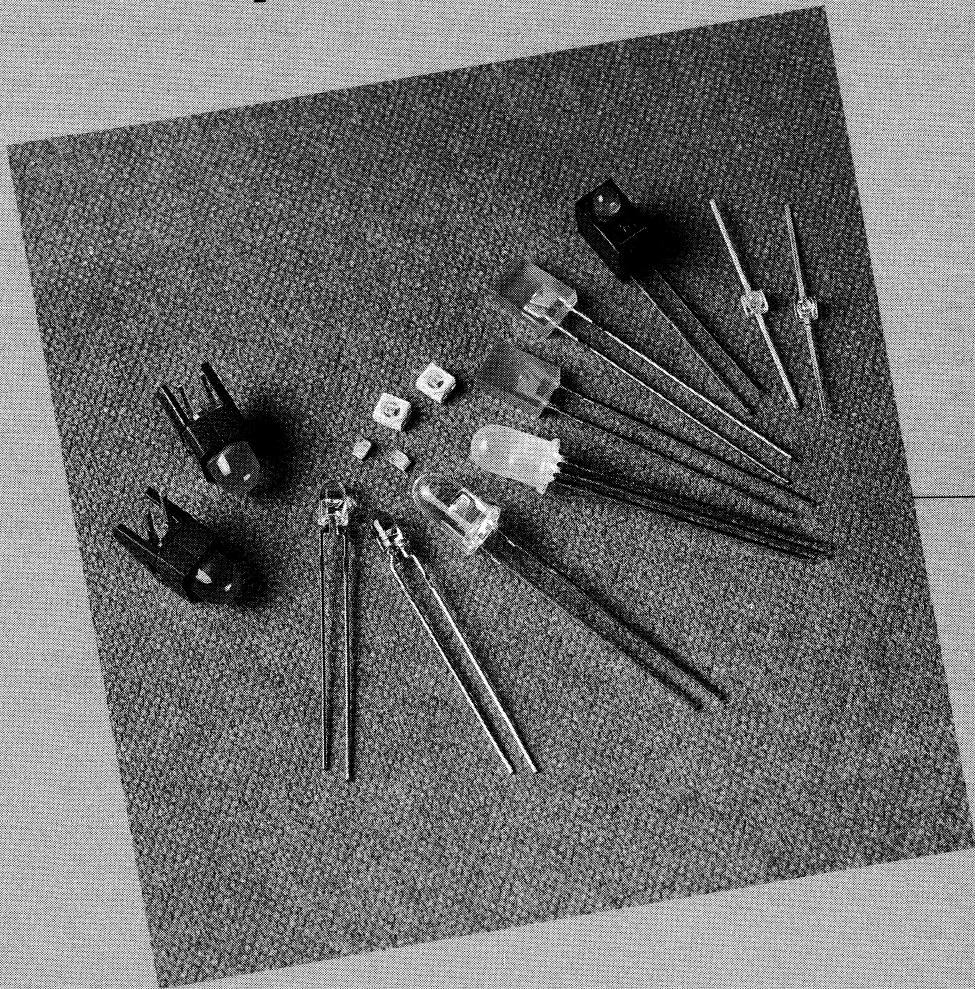

---

## LED Lamps

Hewlett-Packard has expanded its families of LED lamps to include a wide selection from general purpose GaP devices to high brightness AlInGaP devices. High brightness AlInGaP light emitting material technology is now packaged into devices capable of providing the light output necessary for outdoor applications of all kinds.

### *New High Brightness SunPower Series LEDs*

HP's new AS and TS AlInGaP (Absorbing Substrate and Transparent Substrate Aluminum Indium Gallium Phosphide) LEDs, trade named **SunPower Series LEDs**, are available in both through hole and SMT packages.

### *New Revolutionary SunPower-Series, Super Flux LEDs*

Newly developed, low thermal resistance, high flux output LED lamps are now available. These new devices allow operation at higher than normal drive currents, producing sufficient light output to reduce the quantity of lamps in existing designs. The HPWA-DX00/-MX00 series incorporates

AS AlInGaP LED technology. The HPWT-DX00/-MX00 series incorporates TS AlInGaP LED technology for those applications requiring the ultimate in light output performance. Popular applications for these newly developed **Super Flux LED** devices are interior and exterior automotive lighting, moving message panel displays, and those applications incorporating light guides.

### *New SunPower Series T-1<sup>3/4</sup>, (5 mm) Precision Optical Performance AlInGaP LED Lamps*

These new precision optical performance LED lamp devices produce the necessary outdoor luminance for roadway signs and traffic signals that must be easily seen by motorists in both bright sunlight and adverse weather conditions. These devices also are ideal for full matrix outdoor advertising signs, displaying both messages and graphics. These **Precision Optical Performance T-1<sup>3/4</sup>, 5 mm** AlInGaP lamps are direct replacement for incandescent and quartz halogen-fiber optic technologies.

### *Brightest SunPower Series SMT LEDs in the World*

Packaging HP's new AlInGaP LED technology into a broad selection of surface mount technology (SMT) packages provide light output performance unmatched in the industry for demanding surface mount applications. These new advanced SMT LED devices provide designers with high brightness indicator options on pc board assemblies where SMT is the primary pc board assembly technology. The HLMT-Q100 is the world's first 1 candela SMT LED indicator device, bright enough to replace subminiature incandescent lamps at comparable cost. In many instances, designers may find these new AlInGaP SMT LED devices will easily replace through hole LED components, with the same or better optical performance.



## Visible LED Device Classifications with Respect to the European CENELEC EN60825-1 Standard

The 1996 revised European CENELEC EN60825-1 Standard requires manufacturers to determine if eye safety labels should be placed on their products that contain certain high luminance LED devices. Not all LED devices produce sufficient luminance to require eye safety labeling. Only certain LED device types utilizing the new high performance LED technologies may require end product safety labeling. The need to place eye safety labeling on a products using LED devices is dependent upon the product design and the use conditions for the LEDs. The criterion for eye safety labeling is the luminous output of LED devices in end products compared against an Accessible Emission Limit (AEL).

LED devices are classified in the IEC 825-1 and CENELEC EN60825-1 Standards as either AEL Class 1 or AEL Class 2 depending upon the luminous output of the device compared against the AEL intensity for that device. Most LED devices are classified as AEL Class 1 devices. End products that utilize AEL Class 1 LED devices do not require eye safety labeling on the product. However, AEL Class 1 notification is required in the product's user documentation. Some LED devices utilizing the new high performance LED technologies can produce sufficient luminance to be classified as Class 2 devices. Those end products that utilize Class 2 LED devices may require eye safety labeling, depending upon the drive conditions, filtering, and other design parameters.

Hewlett-Packard provides eye safety labeling on the shipment packaging for LED products that are measured to be AEL Class 2 LED devices when driven at the data sheet maximum dc drive current. It is the responsibility of the manufacturer of products utilizing AEL Class 2 LED devices to comply with the requirements of the IEC 825-1 and CENELEC EN60825-1 Standards and properly label products according to their measured classification.

### EYE SAFETY INFORMATION

These LED devices are measured to be AEL Class 2 LED Products per IEC 825-1 and CENELEC EN60825-1 Standards when operated at the maximum data sheet dc drive current. For eye safety, do not stare into the light beam of these LED devices at close range.

For additional information on Hewlett-Packard LED devices with regard to the IEC 825-1 and CENELEC EN60825-1 Standards, request Application Brief I-015 through your local sales office.

For information on AEL values, LED classifications, and product labeling per the CENELEC EN 60825-1 Standard, refer to Hewlett-Packard Application Brief I-015.

## Visible LED Devices and Eye Safety with Respect to MPE Values as Defined in the European IEC 825-1 Standard

Under normal use conditions, LED luminance and eye safety is usually not a concern. LED devices are safe for normal viewing in final product assemblies where eye safety considerations have been included in the design of those products and those products are utilized under normal intended use conditions.

Some LED devices utilizing new high performance LED technologies can produce sufficient luminance to raise a concern for eye safety when viewed under non-normal use conditions. The criteria for evaluating the luminous output of LED devices and eye safety are **Maximum Permissible Exposure (MPE)** values defined in the European IEC-825-1 Standard. Viewing an LED device at the MPE test conditions is considered to have the possibility of causing eye injury to an observer when the high luminance of an LED device exceeds the MPE value for that device. Manufacturers utilizing high luminance LED devices in their products should take into account eye safety in the intended use and design of those products.

For information on MPEs and eye safety, refer to Hewlett-Packard Application Brief I-009.

### Super Flux LEDs

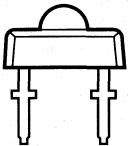
Device		Description			Typical Luminous Flux @ 70 mA	Viewing Angle 2 $\theta$ <sup>1/2</sup>	Typical Forward Voltage @ 70 mA	Page No.
Package Outline Drawing	Part No.	Color, $\lambda_d$	Package	Lens				
	<i>New!</i>	HPWR-M300	TS AlGaAs Red 643 nm	Square with 4 Leads	Untinted, Nondiffused, 3 mm Dia. Dome	800 mlm	90°	1-25
	<i>New!</i>	HPWA-MH00	AS AlInGaP Red-Orange 615 nm			1250 mlm	90°	
	<i>New!</i>	HPWA-DH00					60°	
	<i>New!</i>	HPWA-ML00	AS AlInGaP Amber 590 nm			1250 mlm	90°	
	<i>New!</i>	HPWA-DL00					60°	
	<i>New!</i>	HPWT-MH00	TS AlInGaP Red-Orange 617 nm			2500 mlm	70°	
	<i>New!</i>	HPWT-DH00					40°	
	<i>New!</i>	HPWT-ML00	TS AlInGaP Amber 592 nm			2500 mlm	70°	
	<i>New!</i>	HPWT-DL00					40°	

### T-1<sup>3/4</sup> (5 mm) High Performance AlInGaP LED Lamps

Device		Sunpower LED Lamps	Description		Typical Luminous Intensity @ 20 mA	Viewing Angle 2 $\theta$ <sup>1/2</sup>	Typical Forward Voltage @ 20 mA	Page No.
Package Outline Drawing	Part No.	Color, $\lambda_d$	Lens					
	<i>New!</i>	HLMT-CL00	Amber 592 nm	Untinted, Nondiffused	8300 mcd	8°	1-37	
	<i>New!</i>	HLMT-CH00	Red-Orange 617 nm		9000 mcd			
	<i>New!</i>	HLMT-DL00	Amber 592 nm		1500 mcd			
	<i>New!</i>	HLMT-DH00	Red-Orange 617 nm		1800 mcd	24°		
		HLMA-CL00	Amber 590 nm		3500 mcd			7°
		HLMA-CH00	Red-Orange 615 nm		3500 mcd			
		HLMA-DL00	Amber 590 nm		800 mcd	24°		
		HLMA-DH00	Red-Orange 615 nm		600 mcd			
		HLMA-DG00	Red-Orange 622 nm		500 mcd			

**T-13/4 (5 mm) Precision Optical Performance AlInGaP LED Lamps**

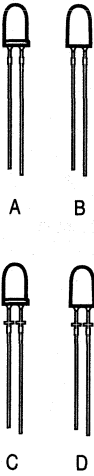
Device		Sunpower Series LEDs	Description			Typical Luminous Intensity @ 20 mA	Viewing Angle 2θ <sup>1/2</sup>	Typical Forward Voltage @ 20 mA	Page No.
Package Outline Drawing		Part No.	Color, λ <sub>d</sub>	Lens	*				
	<i>New!</i>	HLMA-CL20	Amber 592 nm	Untinted, Nondiffused	A	4000 mcd	8°	1.9 V	1-31
	<i>New!</i>	HLMA-GL20			B				
	<i>New!</i>	HLMA-CL22			C				
	<i>New!</i>	HLMA-GL22			D				
	<i>New!</i>	HLMA-CH20	Red-Orange 617 nm	A	4000 mcd				
	<i>New!</i>	HLMA-GH20		B					
	<i>New!</i>	HLMA-CH22		C					
	<i>New!</i>	HLMA-GH22		D					
	<i>New!</i>	HLMA-CL15	Red 630 nm	A	1700 mcd				
	<i>New!</i>	HLMA-GL15		B					
	<i>New!</i>	HLMA-CL17		C					
	<i>New!</i>	HLMA-GL17		D					
	<i>New!</i>	HLMA-CJ15	Amber 590 nm	A	1300 mcd	15°			
	<i>New!</i>	HLMA-GJ15		B					
	<i>New!</i>	HLMA-CJ17		C					
	<i>New!</i>	HLMA-GJ17		D					
<i>New!</i>	HLMA-CH15	Red-Orange 617 nm	A	1300 mcd					
<i>New!</i>	HLMA-GH15		B						
<i>New!</i>	HLMA-CH17		C						
<i>New!</i>	HLMA-GH17		D						
<i>New!</i>	HLMA-CG15	Red 622 nm	A	800 mcd					
<i>New!</i>	HLMA-GG15		B						
<i>New!</i>	HLMA-CG17		C						
<i>New!</i>	HLMA-GG17		D						

\*Denotes package configuration.

**T-1<sup>3</sup>/<sub>4</sub> (5 mm) High Performance AlInGaP, Tinted Diffused, LED Lamps**

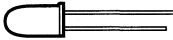
Device		Description		Typical Luminous Intensity @ 20 mA	Viewing Angle 2 $\theta$ <sup>1/2</sup>	Typical Forward Voltage @ 20 mA	Page No.
Package Outline Drawing	Part No.	Color, $\lambda_d$	Lens				
 <i>New!</i>	HLMA-DL05	Amber 592 nm	Tinted, Diffused	100 mcd	65°	1.9 V	1-49
	<i>New!</i>	HLMA-DH05					

**T-1<sup>3</sup>/<sub>4</sub> (5 mm) High Performance TS AlGaAs Red LED Lamps**

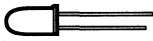
Device		Description		Typical Luminous Intensity @ 20 mA	Viewing Angle 2 $\theta$ <sup>1/2</sup>	Typical Forward Voltage @ 20 mA	Page No.
Package Outline Drawing	Part No.	Color, $\lambda_d$	Lens				
	HLMP-8103	Deep Red 644 nm	Untinted, Nondiffused	3000 mcd	7°	1.85 V	1-44
	HLMP-8102			2000 mcd			
	HLMP-8100			1000 mcd	19°		
	HLMP-C100			750 mcd	30°		
	HLMP-C110			400 mcd	40°		

**T-1<sup>3</sup>/<sub>4</sub> (5 mm) High Performance TS AlGaAs, Tinted Diffused, Red LED Lamps**

Device		Description		Typical Luminous Intensity @ 20 mA	Viewing Angle 2 $\theta$ <sup>1/2</sup>	Typical Forward Voltage @ 20 mA	Page No.
Package Outline Drawing	Part No.	Color, $\lambda_d$	Lens				
 <i>New!</i>	HLMP-D115	Deep Red 644 nm	Tinted, Diffused	250 mcd	40°	1.85 V	1-49
	<i>New!</i>			HLMP-D120	350 mcd		

**T-13/4 (5 mm) Wide Viewing Angle, High Intensity LED Lamps**

Device		Description		Typical Luminous Intensity @ 40 mA	Viewing Angle 2θ <sup>1/2</sup>	Typical Forward Voltage @ 40 mA	Page No.
Package Outline Drawing	Part No.	Color, λ <sub>d</sub>	Lens				
	<i>New!</i> HLMA-VL00	AS AlInGaP Amber 592 nm	Untinted, Nondiffused	460 mcd	60° Horizontal, 30° Vertical	1.90 V	1-56
	<i>New!</i> HLMA-VH00	AS AlInGaP Red-Orange 615 nm					
	<i>New!</i> HLMP-V100	TS AlGaAs Deep Red 644 nm		1000 mcd		1.85 V	
	<i>New!</i> HLMP-V500	GaP Green 570 nm		270 mcd		2.2 V	

**T-13/4 (5 mm) SiC Blue LED Lamps**

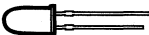
Device		Description		Typical Luminous Intensity @ 20 mA	Viewing Angle 2θ <sup>1/2</sup>	Typical Forward Voltage @ 20 mA	Page No.
Package Outline Drawing	Part No.	Color, λ <sub>d</sub>	Lens				
	HLMP-DB00	Blue 480 nm	Diffused	3 mcd	38°	3.5 V	1-62
	HLMP-DB15		Untinted, Nondiffused	12 mcd	15°		

**T-13/4 (5 mm) High Intensity DH AlGaAs LED Lamps**

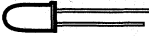
Device		Description		Typical Luminous Intensity @ 20 mA	Viewing Angle 2θ <sup>1/2</sup>	Typical Forward Voltage @ 20 mA	Page No.
Package Outline Drawing	Part No.	Color, λ <sub>d</sub>	Lens				
	HLMP-D101	Deep Red 637 nm	Tinted, Diffused	70 mcd	65°	1.8 V	1-66
	HLMP-D105		Untinted, Nondiffused	240 mcd	24°		

**T-13/4 (5 mm) Low Current DH AlGaAs Lamps**

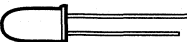
Device		Description		Typical Luminous Intensity @ 1 mA	Viewing Angle 2θ <sup>1/2</sup>	Typical Forward Voltage @ 1 mA	Page No.
Package Outline Drawing	Part No.	Color, λ <sub>d</sub>	Lens				
	HLMP-D150	Deep Red 637 nm	Tinted, Diffused	3 mcd	65°	1.6 V	1-71
	HLMP-D155		Untinted, Nondiffused	10 mcd	24°		

### T-1<sup>3</sup>/<sub>4</sub> (5 mm) Very High Intensity DH AlGaAs Lamps\*

Device		Description		Typical Luminous Intensity @ 20 mA	Viewing Angle 2 $\theta$ <sup>1/2</sup>	Typical Forward Voltage @ 20 mA	Page No.
Package Outline Drawing	Part No.	Color, $\lambda_d$	Lens				
	HLMP-4100	Deep Red 637 nm	Untinted, Nondiffused	750 mcd	8°	1.8 V	*
	HLMP-4101			1000 mcd			

\*Contact your local Hewlett-Packard components sales representative for information regarding these products.

### T-1<sup>3</sup>/<sub>4</sub> (5 mm) Super Ultra-Bright LED Lamps

Device		Description		Typical Luminous Intensity @ 20 mA	Viewing Angle 2 $\theta$ <sup>1/2</sup>	Typical Forward Voltage @ 20 mA	Page No.
Package Outline Drawing	Part No.	Color, $\lambda_d$	Lens				
	HLMP-8115	DH AlGaAs Deep Red 637 nm	Aspheric Dome, Untinted, Nondiffused	1000 mcd	10°	1.8 V	1-75
	HLMP-8109			500 mcd	20°		
	HLMP-8205	GaAsP/GaP HER 626 nm		350 mcd	10°	1.9 V	
	HLMP-8209			260 mcd	20°		
	HLMP-8305	GaAsP/GaP Yellow 585 nm		350 mcd	10°	2.1 V	
	HLMP-8309			260 mcd	20°		
	HLMP-8405	GaAsP/GaP Orange 602 nm		350 mcd	10°	1.9 V	
	HLMP-8409			260 mcd	20°		
	HLMP-8505	GaP/GaP Green 569 nm		400 mcd	10°	2.2 V	
	HLMP-8509			300 mcd	20°		
HLMP-8605	GaP/GaP Emerald Green 560 nm	75 mcd	10°				

### T-1<sup>3</sup>/<sub>4</sub> (5 mm) Ultra-Bright LED Lamps

Device		Description		Typical Luminous Intensity @ 20 mA	Viewing Angle 2 $\theta$ <sup>1/2</sup>	Typical Forward Voltage @ 20 mA	Page No.		
Package Outline Drawing	Part No.	Color, $\lambda_d$	Lens						
	HLMP-3750	GaAsP/GaP HER 626 nm	Standard Dome Untinted, Nondiffused	125 mcd	24°	1.9 V	1-83		
	HLMP-3850			GaAsP/GaP Yellow 585 nm				140 mcd	2.1 V
	HLMP-3950					GaP/GaP Green 569 nm		140 mcd	2.2 V
	HLMP-D640			GaP/GaP Emerald Green 558 nm				21 mcd	
	HLMP-3390	GaAsP/GaP HER 626 nm		Low Profile Aspheric Dome, Untinted, Nondiffused	55 mcd	32°		1.9 V	
	HLMP-3490							GaAsP/GaP Yellow 585 nm	2.1 V
	HLMP-3590							GaP/GaP Green 569 nm	2.2 V

### T-1<sup>3</sup>/<sub>4</sub> (5 mm) High Intensity LED Lamps

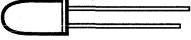
Device		Description		Typical Luminous Intensity @ 10 mA	Viewing Angle 2θ <sup>1</sup> / <sub>2</sub>	Typical Forward Voltage @ 20 mA	Page No.
Package Outline Drawing	Part No.	Color, λ <sub>d</sub>	Lens				
	HLMP-3315	GaAsP/GaP	Tinted, Nondiffused	40 mcd	35°	1.9 V	1-88
	HLMP-3316	HER 626 nm		60 mcd			
	HLMP-3415	GaAsP/GaP	40 mcd	2.0 V			
	HLMP-3416	Yellow 585 nm	50 mcd				
	HLMP-3517	GaP/GaP	Green 569 nm	50 mcd	24°	2.1 V	
	HLMP-3519	Green 569 nm		70 mcd			

### T-1<sup>3</sup>/<sub>4</sub> (5 mm) Diffused LED Lamps

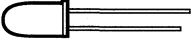
Device		Description		Typical Luminous Intensity @ 10 mA	Viewing Angle 2θ <sup>1</sup> / <sub>2</sub>	Typical Forward Voltage @ 20 mA	Page No.
Package Outline Drawing	Part No.	Color, λ <sub>d</sub>	Lens				
	HLMP-3300	GaAsP/GaP	Tinted, Diffused	3.5 mcd	60°	1.9 V	1-94
	HLMP-3301	HER 626 nm		7 mcd			
	HLMP-3762			12 mcd			
	HLMP-D400	GaAsP/GaP		3.5 mcd		2.0 V	
	HLMP-D401	Orange 602 nm		7 mcd			
	HLMP-3400	GaAsP/GaP		4 mcd			
	HLMP-3401	Yellow 585 nm		8 mcd			
	HLMP-3862			12 mcd			
	HLMP-3502	GaP/GaP		2.4 mcd	2.1 V		
	HLMP-3507	Green 569 nm		5.2 mcd			
	HLMP-3962			14 mcd			
	HLMP-D600	GaP/GaP		3 mcd			
		Emerald Green 558 nm					

### T-1<sup>3</sup>/<sub>4</sub> (5 mm) Low Profile LED Lamps (Non-Diffused)

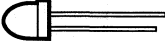
Device		Description		Typical Luminous Intensity @ 10 mA	Viewing Angle 2θ <sup>1</sup> / <sub>2</sub>	Typical Forward Voltage @ 20 mA	Page No.
Package Outline Drawing	Part No.	Color, λ <sub>d</sub>	Lens				
	HLMP-3365	GaAsP/GaP	Aspheric Dome,	10 mcd	45°	1.9 V	1-101
	HLMP-3366	HER 626 nm		18 mcd			
	HLMP-3465	GaAsP/GaP	12 mcd	Tinted, Nondiffused		2.0 V	
	HLMP-3466	Yellow 585 nm	18 mcd				
	HLMP-3567	GaP/GaP	7 mcd		40°	2.1 V	
	HLMP-3568	Green 569 nm	15 mcd				

### T-1 $\frac{1}{4}$ (5 mm) Low Profile LED Lamps (Diffused)

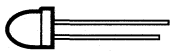
Device		Description		Typical Luminous Intensity @ 10 mA	Viewing Angle 2 $\theta$ $\frac{1}{2}$	Typical Forward Voltage	Page No.
Package Outline Drawing	Part No.	Color, $\lambda_d$	Lens				
	HLMP-3350	GaAsP/GaP	Aspheric, Tinted, Diffused	3.5 mcd	50°	1.9 V @ 10 mA	1-101
	HLMP-3351	HER 626 nm		7 mcd			
	HLMP-3450	GaAsP/GaP		4 mcd			
	HLMP-3451	Yellow 585 nm		10 mcd			
	HLMP-3553	GaP/GaP		3.2 mcd			
	HLMP-3554	Green 569 nm		10 mcd			

### T-1 $\frac{1}{4}$ (5 mm) Low Current LED Lamps

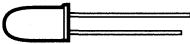
Device		Description		Typical Luminous Intensity @ 2 mA	Viewing Angle 2 $\theta$ $\frac{1}{2}$	Typical Forward Voltage @ 2 mA	Page No.
Package Outline Drawing	Part No.	Color, $\lambda_d$	Lens				
	HLMP-4700	GaAsP/GaP HER 626 nm	Tinted, Diffused	2.3 mcd	50°	1.8 V	1-108
	HLMP-4719	GaAsP/GAP Yellow 585 nm		2.1 mcd		1.9 V	
	HLMP-4740	GaP/GaP Green 569 nm		2.3 mcd		1.8 V	

### T-1 $\frac{1}{4}$ (5 mm) 5 Volt, 12 Volt, Integrated Resistor LED Lamps

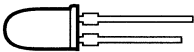
Device		Description		Typical Luminous Intensity	Viewing Angle 2 $\theta$ $\frac{1}{2}$	Typical Current, Voltage	Page No.	
Package Outline Drawing	Part No.	Color, $\lambda_d$	Lens					
	HLMP-3600	GaAsP/GaP HER 626 nm	Tinted, Diffused	8 mcd @ 5 V	60°	10 mA @ 5 V	1-113	
	HLMP-3601					13 mA @ 12 V		
	HLMP-3650	GaAsP/GaP Yellow 585 nm				8 mcd @ 5 V		10 mA @ 5 V
	HLMP-3651					8 mcd @ 12 V		13 mA @ 12 V
	HLMP-3680	GaP/GaP Green 569 nm				8 mcd @ 5 V		10 mA @ 5 V
	HLMP-3681					8 mcd @ 12 V		13 mA @ 12 V



### T-1<sup>3/4</sup> (5 mm) Bicolor LED Lamps

Device		Description		Typical Luminous Intensity @ 10 mA	Viewing Angle 2θ <sup>1/2</sup>	Typical Forward Current @ 10 mA	Page No.
Package Outline Drawing	Part No.	Color, λ <sub>d</sub>	Lens				
	HLMP-4000	GaAsP/GaP HER 626 nm	Untinted, Diffused	5 mcd	65°	1.9 V	1-157
		GaP/GaP Green 569 nm		8 mcd		2.1 V	

### T-1<sup>3/4</sup> (5 mm) LED Lamp Mounting Hardware

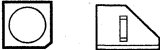
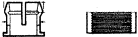
Device		Description	Page No.
Package Outline Drawing	Part No.		
	HLMP-5029	Right Angle Mount Housing	1-120
	HLMP-0104	Panel Mount Clip and Retaining Ring	1-122

### T-1 (3 mm) High Performance AS AlInGaP LED Lamps

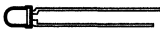
Device		Description		Typical Luminous Intensity @ 20 mA	Viewing Angle 2θ <sup>1/2</sup>	Typical Forward Voltage @ 20 mA	Page No.
Package Outline Drawing	Part No.	Color, λ <sub>d</sub>	Lens				
	HLMA-KL00	AlInGaP Amber 590 nm	Untinted, Nondiffused	200 mcd	45°	1.9 V	1-37
	HLMA-KH00	AlInGaP Red-Orange 615 nm					

### T-1 (3 mm) High Performance TS AlGaAs Red LED Lamps

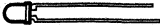
Device		Description		Typical Luminous Intensity	Viewing Angle 2θ <sup>1/2</sup>	Typical Forward Voltage @ 20 mA	Page No.
Package Outline Drawing	Part No.	Color, λ <sub>d</sub>	Lens				
	<i>New!</i> HLMP-J105	Deep Red 644 nm	Untinted, Nondiffused	340 mcd @ 20 mA	45°	1.9 V	1-124
	<i>New!</i> HLMP-J155 Low Current			6 mcd @ 0.5 mA		1.6 V	
	<i>New!</i> HLMP-J100	Tinted, Diffused	175 mcd @ 20 mA	55°	1.9 V		
	<i>New!</i> HLMP-J150 Low Current		3 mcd @ 0.5 mA	1.6 V			

### T-1 (3 mm) High Intensity DH AlGaAs Red LED Lamps

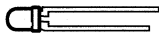
Device		Description		Typical Luminous Intensity @ 20 mA	Viewing Angle 2 $\theta$ <sup>1/2</sup>	Typical Forward Voltage @ 20 mA	Page No.
Package Outline Drawing	Part No.	Color, $\lambda_d$	Lens				
	HLMP-K101	Deep Red 637 nm	Tinted, Diffused	45 mcd	60°	1.8 V	1-66
	HLMP-K105		Untinted, Nondiffused	65 mcd	45°		

### T-1 (3 mm) Low Current DH AlGaAs Red LED Lamps

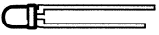
Device		Description		Typical Luminous Intensity @ 1 mA	Viewing Angle 2 $\theta$ <sup>1/2</sup>	Typical Forward Voltage @ 1 mA	Page No.
Package Outline Drawing	Part No.	Color, $\lambda_d$	Lens				
	HLMP-K150	Deep Red 637 nm	Tinted, Diffused	2 mcd	60°	1.6 V	1-71
	HLMP-K155		Untinted, Nondiffused	3 mcd	45°		

### T-1 (3 mm) Ultra-Bright LED Lamps

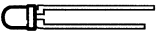
Device		Description		Typical Luminous Intensity @ 20 mA	Viewing Angle 2 $\theta$ <sup>1/2</sup>	Typical Forward Voltage @ 20 mA	Page No.
Package Outline Drawing	Part No.	Color, $\lambda_d$	Lens				
	HLMP-1340	GaAsP/GaP HER 626 nm	Untinted, Nondiffused	45 mcd	45°	1.9 V	1-83
	HLMP-1440					GaAsP/GaP Yellow 585 nm	
	HLMP-1540	GaP/GaP Green 569 nm		2.2 V			
	HLMP-K640	GaP/GaP Emerald Green 560 nm		21 mcd			

### T-1 (3 mm) High Intensity LED Lamps

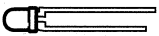
Device		Description		Typical Luminous Intensity @ 10 mA	Viewing Angle 2 $\theta$ <sup>1/2</sup>	Typical Forward Voltage @ 10 mA	Page No.
Package Outline Drawing	Part No.	Color, $\lambda_d$	Lens				
	HLMP-1320	GaAsP/GaP HER 626 nm	Untinted, Nondiffused	30 mcd	45°	1.9 V	1-128
	HLMP-1321					Tinted, Nondiffused	
	HLMP-1420	GaAsP/GaP Yellow 585 nm	Untinted, Nondiffused	15 mcd		2.0 V	
	HLMP-1421					Tinted, Nondiffused	
	HLMP-1520	GaP/GaP Green 596 nm	Untinted, Nondiffused	22 mcd		2.1 V	
	HLMP-1521					Tinted, Nondiffused	

**T-1 (3 mm) Diffused LED Lamps**

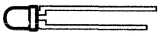
Device		Description		Typical Luminous Intensity @ 10 mA	Viewing Angle 2θ <sup>1/2</sup>	Typical Forward Voltage @ 10 mA	Page No.
Package Outline Drawing	Part No.	Color, λ <sub>d</sub>	Lens				
	HLMP-1300	GaAsP/GaP HER 626 nm	Tinted, Diffused	5 mcd	60°	1.9 V	1-134
	HLMP-1301			5.5 mcd			
	HLMP-1302			7 mcd			
	HLMP-1385			11 mcd			
	HLMP-K400	GaAsP/GaP Orange 602 nm		5 mcd		1.9 V	
	HLMP-K401			5.5 mcd			
	HLMP-K402			7 mcd			
	HLMP-1400	GaAsP/GaP Yellow 585 nm		5 mcd		2.0 V	
	HLMP-1401			6 mcd			
	HLMP-1402			7 mcd			
	HLMP-1485			10 mcd			
	HLMP-1503	GaP/GaP Green 569 nm		5 mcd		2.1 V	
	HLMP-1523			7 mcd			
	HLMP-1585			8.5 mc			
HLMP-K600	GaP/GaP Emerald Green 560 nm	4.5 mcd	2.1 V				

**T-1 (3 mm) Low Current LED Lamps**

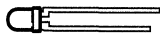
Device		Description		Typical Luminous Intensity @ 20 mA	Viewing Angle 2θ <sup>1/2</sup>	Typical Forward Voltage @ 2 mA	Page No.
Package Outline Drawing	Part No.	Color, λ <sub>d</sub>	Lens				
	HLMP-1700	GaAsP/GaP HER 626 nm	Tinted, Diffused	2.1 mcd	50°	1.8 V	1-108
	HLMP-1719	GaAsP/GaP Yellow 585 nm		1.6 mcd		1.9 V	
	HLMP-1790	GaP/GaP Green 569 nm		2.1 mcd		1.8 V	

**T-1 (3 mm) 5 Volt, 12 Volt, Integrated Resistor LED Lamps**

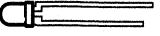
Device		Description		Typical Luminous Intensity	Viewing Angle 2θ <sup>1/2</sup>	Typical Current, Voltage	Page No.
Package Outline Drawing	Part No.	Color, λ <sub>d</sub>	Lens				
	HLMP-1600	GaAsP/GaP HER 626 nm	Tinted, Diffused	8 mcd @ 5 V		10 mA @ 5 V	1-113
	HLMP-1601			8 mcd @ 12 V		13 mA @ 12 V	
	HLMP-1620	GaAsP/GaP Yellow 585 nm		8 mcd @ 5 V		10 mA @ 5 V	
	HLMP-1621			8 mcd @ 12 V		13 mA @ 12 V	
	HLMP-1640	GaP/GaP Green 569 nm		8 mcd @ 5 V		10 mA @ 5 V	
	HLMP-1641			8 mcd @ 12 V		13 mA @ 12 V	

### T-1<sup>3</sup>/<sub>4</sub> (5 mm) and T-1 (3 mm) Tape and Reel Options

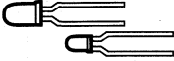
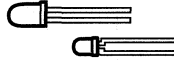
Device		Option No.	Description	Page No.
Package Outline Drawing				
 5 mm (0.197 in) Formed Leads		001	T-1 <sup>3</sup> / <sub>4</sub> , with 5 mm (0.197 in) Formed Leads, 1300 Lamps per Reel.	1-140
			T-1, with 5 mm (0.197 in) Formed Leads, 1800 Lamps per Reel.	
 2.54 mm (0.100 in) Straight Leads		002	T-1 <sup>3</sup> / <sub>4</sub> , with 2.54 mm (0.100 in) Straight Leads, 1300 Lamps per Reel.	
			T-1, with 2.54 mm (0.100 in) Straight Leads, 1800 Lamps per Reel.	

### T-1 (3 mm) Right Angle LED Indicator Array Options

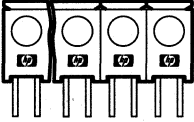
Device		Option Code	Description	Page No.
Package Outline Drawing				
		102	2-Element Array	1-147
		103	3-Element Array	
		104	4-Element Array	
		105	5-Element Array	
		106	6-Element Array	
		107	7-Element Array	
		108	8-Element Array	

### 2.5 mm X 7.6 mm Rectangular LED Lamps

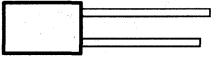
Device		Description		Typical Luminous Intensity @ 20 mA	Viewing Angle 2 $\theta$ <sup>1</sup> / <sub>2</sub>	Typical Forward Voltage @ 20 mA	Page No.
Package Outline Drawing	Part No.	Color, $\lambda_d$	Lens				
	HLMP-R100	DH AlGaAs Red 637 nm	Tinted, Diffused	11 mcd	100°	1.6 V	1-149
	HLMP-0300	GaAsP/GaP		2.5 mcd		1.9 V	
	HLMP-0301	HER 626 nm		5.3 mcd			
	HLMP-0400	GaAsP/GaP		2.5 mcd	2.1 V		
	HLMP-0401	Yellow 585 nm		5 mcd			
	HLMP-0503	GaP/GaP		2.5 mcd	2.2 V		
	HLMP-0504	Green 569 nm		8 mcd			

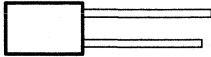

### 2 mm x 5 mm Rectangular LED Lamps

Device		Description		Typical Luminous Intensity @ 20 mA	Viewing Angle 2θ <sup>1/2</sup>	Typical Forward Voltage @ 20 mA	Page No.
Package Outline Drawing	Part No.	Color, λ <sub>d</sub>	Lens				
	HLMP-S100	DH AlGaAs Deep Red 637 nm	Tinted, Diffused	7.5 mcd	110°	1.8 V	1-153
	HLMP-S200	GaAsP/Ga		3.5 mcd		1.9 V	
	HLMP-S201	HER 626 nm		7.5 mcd			
	HLMP-S400	GaAsP/GaP		3.5 mcd			
	HLMP-S401	Orange 602 nm		7.5 mcd			
	HLMP-S300	GaAsP/GaP		2.1 mcd		2.1 V	
	HLMP-S301	Yellow 585 nm		4 mcd			
	HLMP-S500	GaP/GaP		4 mcd		2.2 V	
	HLMP-S501	Green 569 nm		8 mcd			
	HLMP-S600	GaP/GaP Emerald Green 560 nm		3 mcd			

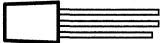
### 2 mm x 5 mm Rectangular Bicolor LED Lamps

Device		Description		Typical Luminous Intensity @ 20 mA	Viewing Angle 2θ <sup>1/2</sup>	Typical Forward Current @ 10 mA	Page No.
Package Outline Drawing	Part No.	Color, λ <sub>d</sub>	Lens				
	HLMP-0800	GaAsP/GaP HER 626 nm	Untinted, Diffused	3.5 mcd	100°	1.9 V	1-157
		GaP/GaP Green 569 nm		4 mcd		2.1 mA	

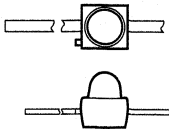
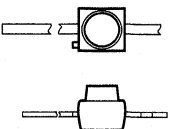
### Subminiature High Performance AlInGaP LED Lamps

Device		Description		Typical Luminous Intensity @ 20 mA	Viewing Angle 2θ <sup>1/2</sup>	Typical Forward Voltage @ 20 mA	Page No.
Package Outline Drawing	Part No.	Color, λ <sub>d</sub>	Lens				
	<i>New!</i> HLMT-QL00	TS AlInGaP Amber 591 nm	Dome, Untinted, Nondiffused	1000 mcd	15°	1.9 V	1-161
	<i>New!</i> HLMA-QL00	AS AlInGaP Amber 591 nm		500 mcd		2.0 V	
	<i>New!</i> HLMT-QH00	TS AlInGaP Red Orange 615 nm		800 mcd		1.9 V	
	<i>New!</i> HLMA-QH00	AS AlInGaP Red Orange 615 nm		500 mcd		2.0 V	
	<i>New!</i> HLMT-PL00	TS AlInGaP Amber 591 nm	Flat Top, Untinted, Nondiffused	150 mcd	125°	1.9 V	
	<i>New!</i> HLMA-PL00	AS AlInGaP Amber 591 nm		75 mcd		2.0 V	
	<i>New!</i> HLMT-PH00	TS AlInGaP Red Orange 615 nm		120 mcd		1.9 V	
	<i>New!</i> HLMA-PH00	AS AlInGaP Red Orange 615 nm		75 mcd		2.0 V	

### Subminiature High Performance TS AlGaAs Red LED Lamps

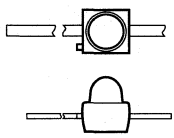
Device		Description		Typical Luminous Intensity @ 20 mA	Viewing Angle 2 $\theta$ <sup>1/2</sup>	Typical Forward Voltage @ 20 mA	Page No.
Package Outline Drawing	Part No.	Color, $\lambda_d$	Lens				
	<i>New!</i>	HLMP-Q106	Deep Red 644 nm	Dome, Untinted, Nondiffused	530 mcd	15°	1-168
	<i>New!</i>	HLMP-Q102		Dome, Tinted, Diffused	160 mcd		
	<i>New!</i>	HLMP-P106	Flat Top, Untinted, Nondiffused	130 mcd	75°		

### Subminiature Low Current TS AlGaAs Red LED Lamps

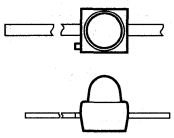
Device		Description		Typical Luminous Intensity @ 0.5 mA	Viewing Angle 2 $\theta$ <sup>1/2</sup>	Typical Forward Voltage @ 0.5 mA	Page No.
Package Outline Drawing	Part No.	Color, $\lambda_d$	Lens				
	<i>New!</i>	HLMP-Q156	Deep Red 644 nm	Dome, Untinted, Nondiffused	7 mcd	15°	1-168
	<i>New!</i>	HLMP-Q152		Dome, Tinted, Diffused	2 mcd		
	<i>New!</i>	HLMP-P156	Flat Top, Untinted, Nondiffused	2 mcd	75°		

### Subminiature Dome LED Lamps

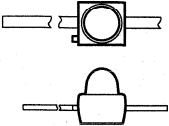
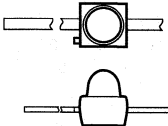
Device		Description		Typical Luminous Intensity @ 10 mA	Viewing Angle 2θ <sup>1/2</sup>	Typical Forward Voltage @ 10 mA	Page No.
Package Outline Drawing	Part No.	Color, λ <sub>d</sub>	Lens				
	HLMP-6000	GaAsP Red	Dome, Tinted, Diffused	1.2 mcd	90°	1.6 V	1-174
	HLMP-6001	640 nm		3.2 mcd			
	HLMP-Q101	DH AlGaAs Deep Red 637 nm		45 mcd @ 20 mA		1.8 V @ 20 mA	
	HLMP-6300	GaAsP/GaP HER 626 nm		7 mcd		1.8 V	
	HLMP-Q400	GaAsP/GaP Orange 602 nm		3 mcd		1.9 V	
	HLMP-6400	GaAsP/GaP Yellow 585 nm				2.0 V	
	HLMP-6500	GaP/GaP Green 569 nm		2.1 V			
	HLMP-Q600	GaP/GaP Emerald Green 560 nm		1.5 mcd		2.2 V	
	HLMP-Q105	DH AlGaAs Deep Red 637 nm	Dome, Untinted, Nondiffused	55 mcd @ 20 mA	28°	1.8 V @ 20 mA	
	HLMP-6305	GaAsP/GaP HER 626 nm		12 mcd		1.8 V	
	HLMP-6405	GaAsP/GaP Yellow 585 nm		2.0 V			
	HLMP-6505	GaP/GaP Green 569 nm		2.1 V			

### Subminiature Flat Top LED Lamps

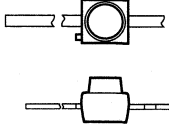
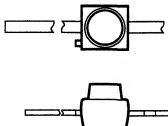
Device		Description		Typical Luminous Intensity @ 10 mA	Viewing Angle 2θ <sup>1/2</sup>	Typical Forward Voltage @ 10 mA	Page No.
Package Outline Drawing	Part No.	Color, λ <sub>d</sub>	Lens				
	HLMP-P105	DH AlGaAs Deep Red 637 nm	Flat Top Untinted, Nondiffused	30 mcd @ 20 mA	125°	1.8 V @ 20 mA	1-174
	HLMP-P205	GaAsP/GaP HER 626 nm		5 mcd		1.8 V	
	HLMP-P405	GaAsP/GaP Orange 602 nm		4 mcd		1.9 V	
	HLMP-P305	GaAsP/GaP Yellow 585 nm		4 mcd		2.0 V	
	HLMP-P505	GaP/GaP Green 569 nm		5 mcd		2.1 V	
	HLMP-P605	GaP/GaP Emerald Green 560 nm		1.5 mcd		2.2 V	
	HLMP-P102	DH AlGaAs Deep Red 637 nm	Flat Top, Untinted, Diffused	20 mcd @ 20 mA	125°	1.8 V @ 20 mA	
	HLMP-P202	GaAsP/GaP HER 626 nm		5 mcd		1.8 V	
	HLMP-P402	GaAsP/GaP Orange 602 nm		4 mcd		1.9 V	
	HLMP-P302	GaAsP/GaP Yellow 585 nm		3 mcd		2.0 V	
	HLMP-P502	GaP/GaP Green 569 nm		6 mcd		2.1 V	

### Subminiature Low Current LED Lamps

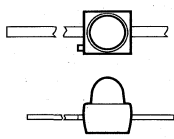
Device		Description		Typical Luminous Intensity	Viewing Angle 2θ <sup>1/2</sup>	Typical Forward Voltage	Page No.
Package Outline Drawing	Part No.	Color, λ <sub>d</sub>	Lens				
	HLMP-Q150	DH AlGaAs Deep Red 637 nm	Dome, Tinted, Diffused	1.8 mcd @ 1 mA	90°	1.6 V @ 1 mA	1-174
	HLMP-Q155			Dome, Untinted, Nondiffused	4 mcd @ 1 mA		
	HLMP-7000	GaAsP/GaP HER 626 nm	Dome, Tinted, Diffused	1 mcd @ 2 mA	90°	1.8 V @ 10 mA	
	HLMP-7019	GaAsP/GaP Yellow 585 nm		0.6 mcd @ 2 mA		2.0 V @ 10 mA	
	HLMP-7040	GaP/GaP Green 569 nm		0.6 mcd @ 2 mA			

### Subminiature Resistor LED Lamps

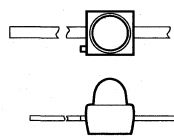
Device		Description		Typical Luminous Intensity @ 5.0 V	Viewing Angle 2θ <sup>1/2</sup>	Typical Forward Current @ 5.0 V	Page No.
Package Outline Drawing	Part No.	Color, λ <sub>d</sub>	Lens				
	HLMP-6600	GaAsP/GaP	Dome, Tinted, Diffused	5 mcd	90°	10 mA	1-174
	HLMP-6620	HER 626 nm		2 mcd		4 mA	
	HLMP-6700	GaAsP/GaP		5 mcd		10 mA	
	HLMP-6720	Yellow 585 nm		2 mcd		4 mA	
	HLMP-6800	GaP/GaP		5 mcd		10 mA	
	HLMP-6820	Green 569 nm		2 mcd		4 mA	





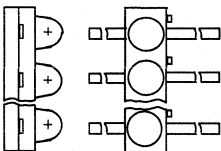





### Subminiature LED Lamp Arrays

Device		Description			Typical Luminous Intensity @ 10 mA	Viewing Angle 2θ <sup>1/2</sup>	Typical Forward Current @ 10 mA	Page No.
Package Outline Drawing	Part No.	*	Color, λ <sub>d</sub>	Lens				
	HLMP-6203	3	GaAsP Red 640 nm	Dome, Tinted, Diffused	1.2 mcd	90°	1.6 V	1-174
	HLMP-6204	4						
	HLMP-6205	5						
	HLMP-6206	6						
	HLMP-6208	8						
	HLMP-6653	3	GaAsP/GaP HER 626 nm		3 mcd	1.8 V		
	HLMP-6654	4						
	HLMP-6655	5						
	HLMP-6656	6						
	HLMP-6658	8						
	HLMP-6753	3	GaAsP/GaP Yellow 585 nm		3 mcd	2.0 V		
	HLMP-6754	4						
	HLMP-6755	5						
	HLMP-6756	6						
	HLMP-6758	8						
	HLMP-6853	3	GaP/GaP Green 569 nm		3 mcd	2.0 V		
HLMP-6854	4							
HLMP-6855	5							
HLMP-6856	6							
HLMP-6858	8							

\*Number of LED Emitters per Array

### Standard SMT and Through Hole Lead Bend Options for Subminiature LED Lamps

Device		Option Code	Description	Page No.
Package Outline Drawing				
	011	SMT Gull Wing Lead, Lamp, Tape and Reel, 1500 Lamps per Reel.	1-188	
	012	SMT Gull Wing Lead, Lamp, Bulk Packaging.		
	013	SMT Gull Wing Lead, Array, Shipping Tube.		
	021	SMT Yoke Lead, Lamp, Tape and Reel, 1500 Lamps per Reel.		
	022	SMT Yoke Lead, Lamp, Bulk Packaging.		
	031	SMT Z-Bend Lead, Lamp, Tape and Reel, 1500 Lamps per Reel.		
	032	SMT Z-Bend Lead, Lamp, Bulk Packaging.		
	1L1	Through Hole, 2.54 mm (0.100 in) Right Angle Bend, Long Leads.		
	1S1	Through Hole, 2.54 mm (0.100 in) Right Angle Bend, Short Leads.		
	2L1	Through Hole, 5.08 mm (0.200 in) Right Angle Bend, Long Leads.		
	2S1	Through Hole, 5.08 mm (0.200 in) Right Angle Bend, Short Leads.		

### Surface Mount High Performance AlInGaP LED Indicators

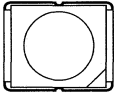
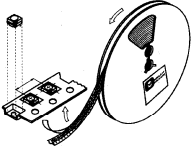
Device		Description			Typical Luminous Intensity @ 10 mA	Viewing Angle 2 $\theta$ <sup>1/2</sup>	Typical Forward Voltage @ 10 mA	Page No.
Package Outline Drawing	Part No.	Color, $\lambda_d$	Package	Lens				
 	<i>New!</i> HSMA-T425	Amber 590 nm	12 mm Tape, 7" reel, 2000 devices	Flat Circle, Untinted, Nondiffused	25 mcd	120°	1.9 V	1-199
	<i>New!</i> HSMA-T525		12 mm Tape, 13" reel, 8000 devices					
	<i>New!</i> HSMA-T625		8 mm Tape, 7" reel, 2000 devices					
	<i>New!</i> HSMA-T725		8 mm Tape, 13" reel, 8000 devices					
	<i>New!</i> HSMD-T425	Orange 603 nm	12 mm Tape, 7" reel, 2000 devices					
	<i>New!</i> HSMD-T525		12 mm Tape, 13" reel, 8000 devices					
	<i>New!</i> HSMD-T625		8 mm Tape, 7" reel, 2000 devices					
	<i>New!</i> HSMD-T725		8 mm Tape, 13" reel, 8000 devices					
	<i>New!</i> HSMJ-T425	Red- Orange 615 nm	12 mm Tape, 7" reel, 2000 devices					
	<i>New!</i> HSMJ-T525		12 mm Tape, 13" reel, 8000 devices					
	<i>New!</i> HSMJ-T625		8 mm Tape, 7" reel, 2000 devices					
	<i>New!</i> HSMJ-T725		8 mm Tape, 13" reel, 8000 devices					

Surface Mount LED Indicators

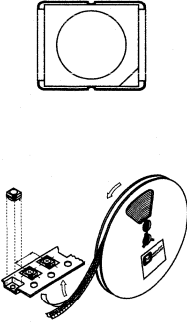
Device		Description			Typical Luminous Intensity @ 10 mA	Viewing Angle 2 $\theta$ <sup>1/2</sup>	Typical Forward Voltage @ 10 mA	Page No.
Package Outline Drawing	Part No.	Color, $\lambda_d$	Package	Lens				
	HSMH-T400	DH AlGaAs Deep Red 637 nm	12 mm Tape, 7" reel, 2000 devices	Flat Circle, Untinted, Nondiffused	17 mcd	120°	1.8 V	1-204
	HSMH-T500		12 mm Tape, 13" reel, 8000 devices					
	HSMH-T600		8 mm Tape, 7" reel, 2000 devices					
	HSMH-T700		8 mm Tape, 13" reel, 8000 devices					
	HSMS-T400	GaAsP/GaP HER 626 nm	12 mm Tape, 7" reel, 2000 devices		6 mcd	1.9 V		
	HSMS-T500		12 mm Tape, 13" reel, 8000 devices					
	HSMS-T600		8 mm Tape, 7" reel, 2000 devices					
	HSMS-T700		8 mm Tape, 13" reel, 8000 devices					
	HSMD-T400	GaAsP/GaP Orange 602 nm	12 mm Tape, 7" reel, 2000 devices		5 mcd	1.9 V		
	HSMD-T500		12 mm Tape, 13" reel, 8000 devices					
	HSMD-T600		8 mm Tape, 7" reel, 2000 devices					
	HSMD-T700		8 mm Tape, 13" reel, 8000 devices					

Surface Mount LED Indicators (contd.)

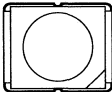
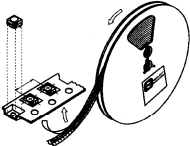
Device		Description			Typical Luminous Intensity @ 10 mA	Viewing Angle 2 $\theta$ <sup>1/2</sup>	Typical Forward Voltage @ 10 mA	Page No.	
Package Outline Drawing	Part No.	Color, $\lambda_d$	Package	Lens					
 	HSMY-T400	GaAsP/GaP Yellow 585 nm	12 mm Tape, 7" reel, 2000 devices	Flat Circle, Untinted, Nondiffused	5 mcd	120°	2.0 V	1-204	
	HSMY-T500		12 mm Tape, 13" reel, 8000 devices						
	HSMY-T600		8 mm Tape, 7" reel, 2000 devices						
	HSMY-T700		8 mm Tape, 13" reel, 8000 devices						
	HSMG-T400	GaP/GaP Green 572 nm	12 mm Tape, 7" reel, 2000 devices		10 mcd	2.0 V			
	HSMG-T500		12 mm Tape, 13" reel, 8000 devices						
	HSMG-T600		8 mm Tape, 7" reel, 2000 devices						
	HSMG-T700		8 mm Tape, 13" reel, 8000 devices						
	<i>New!</i>	HSME-T400	GaP/GaP Emerald Green 560 nm	12 mm Tape, 7" reel, 2000 devices			1.5 mcd		2.2 V
	<i>New!</i>	HSME-T500		12 mm Tape, 13" reel, 8000 devices					
	<i>New!</i>	HSME-T600		8 mm Tape, 7" reel, 2000 devices					
	<i>New!</i>	HSME-T700		8 mm Tape, 13" reel, 8000 devices					



**Surface Mount Chip LEDs**

Device		Description			Typical Luminous Intensity @ 20 mA	Viewing Angle 2 $\theta$ 1/2	Typical Forward Voltage @ 20 mA	Page No.
Package Outline Drawing	Part No.	Color, $\lambda_d$	Package Size	Lens				
<p>-C670 (805)</p> <p>-C650 (1206)</p> <p>-C655 (1210)</p>	HSMH-C650	DH AlGaAs Deep Red	1206	Cube, Diffused	16 mcd	155°	1.8 V	1-212
	HSMH-C670	637 nm	805					
	HSMS-C650	GaAsP/GaP HER	1206		5 mcd	1.9 V		
	HSMS-C670	626 nm	805					
	HSMO-C650	GaAsP/GaP Orange	1206		4 mcd	2.1 V		
	HSMO-C670	604 nm	805					
	HSMY-C650	GaAsP/GaP Yellow	1206		5 mcd	2.1 V		
	HSMY-C670	584 nm	805					
	HSMG-C650	GaP/GaP Green	1206		9 mcd	2.2 V		
	HSMG-C670	571 nm	805					
HSMF-C655	Bicolor HER 626 nm Green 571 nm	1210	5 mcd 9 mcd	1.9 V 2.2 V				

**T-1 $\frac{3}{4}$  (5 mm), T-1 (3 mm), and Subminiature LED Lamp Mounting Options**

Device		Option No.	Description	Page No.
Package Outline Drawing				
		007	T-1 $\frac{3}{4}$ Standard Dome, with HLMP-0104 Clip and Ring.	1-122
		010	T-1 $\frac{3}{4}$ Standard Dome, Right Angle, Leads Sheared Even.	1-118
		100	T-1 $\frac{3}{4}$ Standard Dome, Right Angle, Leads Unsheared, Uneven. Anode Longer.	
		101	T-1, Right Angle, Leads Sheared Even.	1-145
		010	T1, Right Angle, Leads Unsheared, Uneven, Anode Longer.	
		010	Subminiature Right Angle, Leads Sheared Even.	1-197

### Emitter Components\*

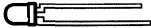
Device		Description		Page No.
Package Outline Drawing	Part No.	Package	Features	
	HEMT-6000	Subminiature 700 nm Deep Red High Intensity Emitter	<ul style="list-style-type: none"> <li>• Visible (Near IR) emission facilitates alignment.</li> <li>• Compatible with most silicon phototransistors and photodiodes.</li> </ul>	*
	HEMT-3301	T-1 <sup>3</sup> / <sub>4</sub> (5 mm) 940 nm IR High Radiant Emitter	<ul style="list-style-type: none"> <li>• Efficiency at low currents.</li> <li>• Radiated spectrum matches response of silicon photodetectors.</li> </ul>	
	HEMT-1001	T-1 (3 mm) 940 nm IR High Radiant Emitter	<ul style="list-style-type: none"> <li>• Non-saturated, high radiant flux output.</li> </ul>	

\*Contact your local Hewlett-Packard components sales representative for information regarding these products.

### Standard Intensity and Color Binning Options for LED Lamps

Device	Description	Page No.
Option Code		
S02	This option provides the selection of lamps from two adjacent luminous intensity, $I_v$ , categories.	1-219
S20	Devices selected to two color bin, $\lambda_d$ , categories.	
S22	Devices selected to two luminous intensity, $I_v$ , categories and two color bin, $\lambda_d$ , categories.	

# Super Flux LEDs

## Technical Data

### SunPower Series

- HPWA-MH00    HPWT-MH00
- HPWA-DH00    HPWT-DH00
- HPWA-ML00    HPWT-ML00
- HPWA-DL00    HPWT-DL00
- HPWR-M300

### Benefits

- Fewer LEDs Required
- Lowers Total System Cost

### Features

- High Flux Output
- Designed for High Current Operation
- Low Thermal Resistance
- Low Profile
- Meets SAE/ECE/JIS Automotive Color Requirements
- Packaged in Tubes for Use with Automatic Pick and Place Equipment

### Applications

- Automotive Exterior Lighting
- Moving Message Panels

- Small and Large Area Displays
- Backlighting

### Description

This revolutionary package design allows the lighting designer to reduce the number of LEDs required and provide a more uniform and unique illuminated appearance than with existing LED solutions. This is possible through the package's efficient optical design and high-current capabilities. The low profile package can be easily coupled to reflectors or lenses to efficiently distribute light and provide the desired illuminated appearance.

This product family employs red, red-orange, and amber LED

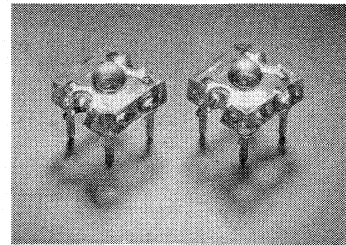

materials, which allow designers to match the color of popular lighting applications, such as automotive tail, stop, and turn signal lamps, and area displays. Included in this family is the world's brightest amber LED material, which is ideal for area displays and general backlighting applications.

### Device Selection Guide

Part Number	LED Color	Total Flux $\phi_v$ (mIm) @ 70 mA <sup>[1]</sup> Typ.	Viewing Angle 2 $\theta$ <sup>1/2</sup> (Degrees) Typ.
HPWR-M300	TS AlGaAs Red	800	90
HPWA-MH00	AS AlInGaP Red-Orange	1250	90
HPWA-DH00			60
HPWA-ML00	AS AlInGaP Amber	1250	90
HPWA-DL00			60
HPWT-MH00	TS AlInGaP Red-Orange	2500	70
HPWT-DH00			40
HPWT-ML00	TS AlInGaP Amber	2500	70
HPWT-DL00			40

#### Notes:

1.  $\phi_v$  is the total luminous flux output as measured with an integrating sphere.
2.  $\theta^{1/2}$  is the off axis angle from optical centerline where the luminous intensity is  $1/2$  the on-axis value.

## Outline Drawing

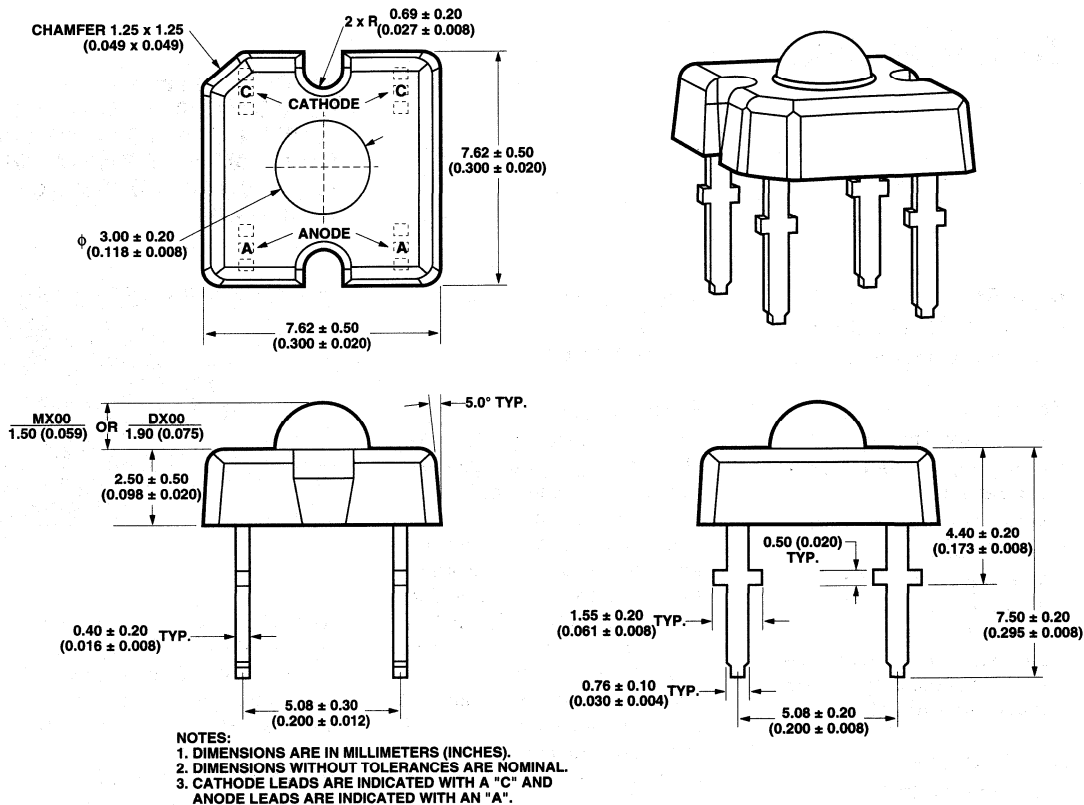

## Absolute Maximum Ratings at T<sub>A</sub> = 25°C

Parameter	HPWR-M300	HPWA-MX00/DX00	HPWT-MX00/DX00	Units
DC Forward Current <sup>[1]</sup>	70	70 <sup>[2,3]</sup>	70 <sup>[2,3]</sup>	mA
Power Dissipation	161	147	193	mW
Reverse Voltage (I <sub>R</sub> = 100 μA)	10	10	10	V
Operating Temperature Range	-40 to +100	-40 to +100	-40 to +100	°C
Storage Temperature	-55 to +100	-55 to +100	-55 to +100	°C
High Temperature Chamber	125°C, 2 hrs. max.			
LED Junction Temperature	125°C			
Solder Conditions				
Preheat Temperature	100°C			
Solder Temperature	260°C for 5 seconds [1.5 mm (0.06 in.) below seating plane]			

### Notes:

- Derate linearly as shown in Figure 4a and 4b.
- Drive Currents between 10 mA and 30 mA are recommended for best long term performance.
- Operation at currents below 10 mA is not recommended, please contact your Hewlett-Packard sales representative.



### Optical Characteristics at $T_A = 25^\circ\text{C}$

Part Number	Total Flux $\phi_v$ (mlm) @ 70 mA <sup>[1]</sup>		Peak Wavelength $\lambda_{\text{peak}}$ (nm) Typ.	Color, Dominant Wavelength $\lambda_d$ (nm) <sup>[2]</sup> Typ.	Total Included Angle $\theta_{0.90V}$ (Degrees) <sup>[3]</sup> Typ.	Luminous Intensity/Total Flux $I_v$ (mcd)/ $\phi_v$ (mlm) Typ.
	Min.	Typ.				
HPWR-M300	500	800	655	643	95	0.7
HPWA-MH00	500	1250	621	615	95	0.6
HPWA-DH00					75	0.85
HPWA-ML00	500	1250	592	590	95	0.6
HPWA-DL00					75	0.85
HPWT-MH00	990	2500	626	617	100	0.6
HPWT-DH00					70	1.25
HPWT-ML00	990	2500	594	592	100	0.6
HPWT-DL00					70	1.25

**Notes:**

- $\phi_v$  is the total luminous flux output as measured with an integrating sphere.
- The dominant wavelength is derived from the CIE Chromaticity Diagram and represents the color of the device.
- $\theta_{0.90V}$  is the included angle at which 90% of the total luminous flux is captured.

### Electrical Characteristics at $T_A = 25^\circ\text{C}$

Part Number	Forward Voltage $V_F$ (Volts) @ $I_F = 70$ mA			Reverse Breakdown $V_R$ (Volts) @ $I_R = 100$ $\mu\text{A}$		Capacitance $C$ (pF) $V_F = 0$ , $f = 1$ MHz Typ.	Thermal Resistance $R\theta_{J-PIN}$ ( $^\circ\text{C}/\text{W}$ ) Typ.	Speed of Response $\tau_s$ (ns) <sup>[1]</sup> Typ.
	Min.	Typ.	Max.	Min.	Typ.			
HPWR-M300	2.01	2.25	2.75	10	20	20	155	45
HPWA-MH00/DH00	2.01	2.25	2.75	10	20	40	155	13
HPWA-ML00/DL00	2.01	2.25	2.75	10	20	40	155	13
HPWT-MH00/DH00	2.25	2.65	3.00	10	20	40	125	13
HPWT-ML00/DL00	2.25	2.65	3.00	10	20	40	125	13

**Note:**

- $t_s$  is the time constant,  $e^{-t/\tau_s}$ .

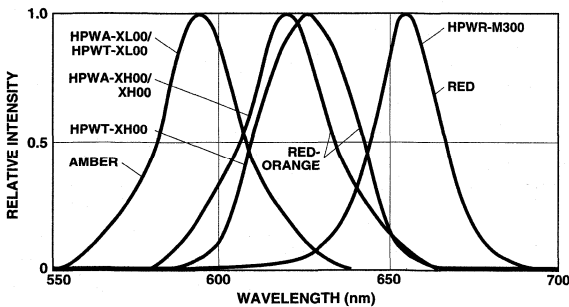

Figure 1. Relative Intensity vs. Wavelength.

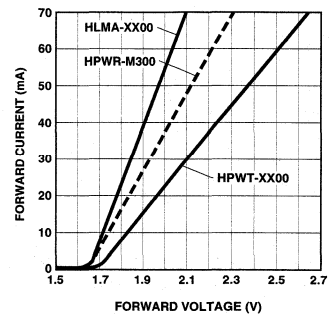

Figure 2. Forward Current vs. Forward Voltage.

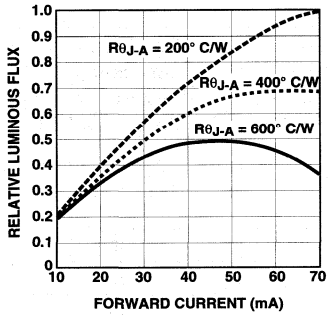

Figure 3a. HPWR-M300 Relative Luminous Flux vs. Forward Current.

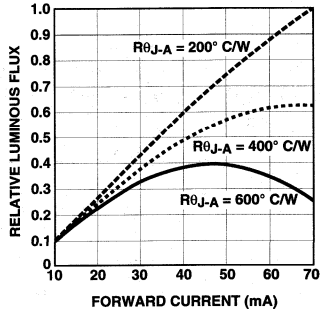

Figure 3b. HPWA/HPWT-XX00 Relative Luminous Flux vs. Forward Current.

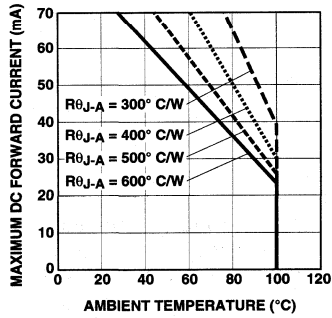

Figure 4a. HPWR-M300/HPWA-XX00 Maximum DC Forward Current vs. Ambient Temperature.

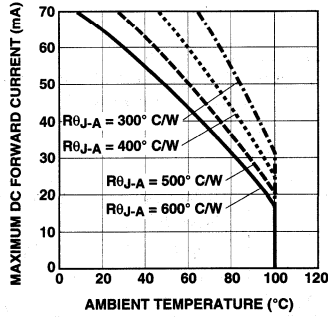

Figure 4b. HPWT-XX00 Maximum DC Forward Current vs. Ambient Temperature.

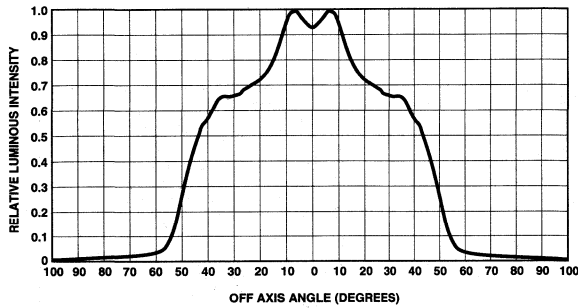

Figure 5a. HPWR-M300, HPWA-MX00 Relative Luminous Intensity vs. Off Axis Angle.

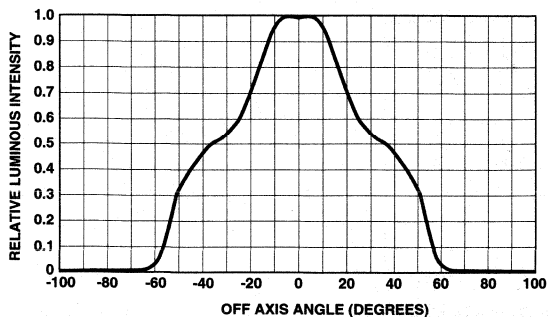

Figure 5b. HPWT-MX00 Relative Luminous Intensity vs. Off Axis Angle.

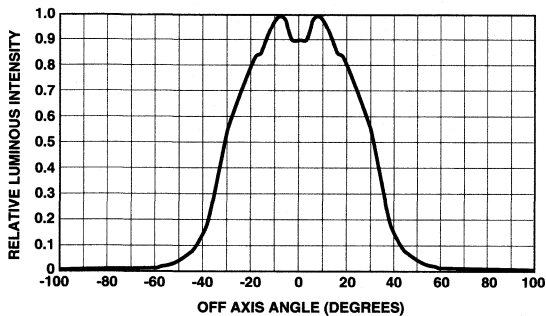

Figure 5c. HPWA-DX00 Relative Luminous Intensity vs. Off Axis Angle.

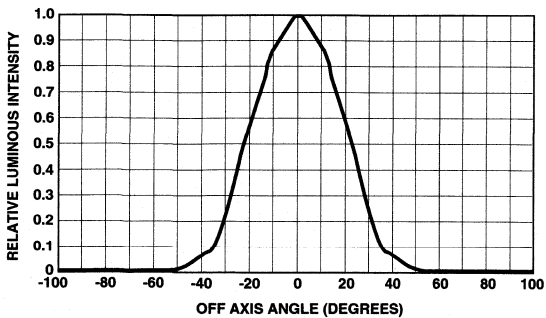

Figure 5d. HPWT-DX00 Relative Luminous Intensity vs. Off Axis Angle.

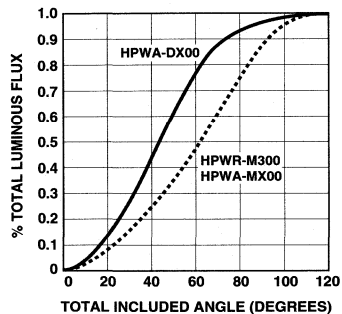

Figure 6a. HPWR-M300/HPWA-XX00 Percent Total Luminous Flux vs. Total Included Angle.

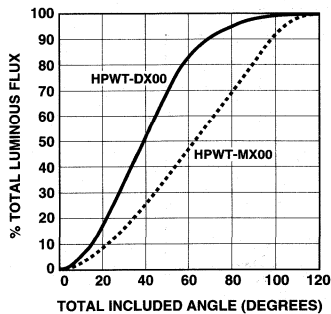

Figure 6b. HPWT-XX00 Percent Total Luminous Flux vs. Total Included Angle.

# T-1<sup>3</sup>/<sub>4</sub> (5 mm) Precision Optical Performance AlInGaP LED Lamps

## Technical Data

**SunPower Series**  
**HLMA-CHXX/CJXX/  
CLXX/CGXX**  
**HLMA-GHXX/GJXX/  
GLXX/GGXX**

### Features

- **Well Defined Spatial Radiation Patterns**
- **Viewing Angles: 8°, 15°**
- **High Luminous Output**
- **Colors:**  
590 nm Amber  
605 nm Portland Orange  
615 nm Reddish-Orange  
622 nm Red
- **High Operating Temperature:**  
 $T_{J LED} = +130^{\circ}C$
- **Superior Resistance to Moisture**
- **Four Package Options:**  
With or Without Flange Base;  
With or Without Lead Stand-Offs

### Benefits

- **Viewing Angles Match Outdoor Sign Requirements**
- **Colors Meet Automotive and Pedestrian Signal Specifications**
- **Superior Performance in Outdoor Environments**
- **Suitable for Autoinsertion onto PC Boards**

### Applications

- **Traffic Management:**  
Pedestrian Signals  
Work Zone Warning Lights  
Variable Message Signs
- **Commercial Outdoor Advertising:**  
Signs  
Marquees
- **Automotive:**  
Exterior and Interior Lights

### Description

These precision performance lamps utilize the absorbing substrate aluminum indium gallium phosphide (AS AlInGaP) LED technology. The luminous flux produced by AS AlInGaP technology provides sufficient light output for readability in sunlight. AS AlInGaP LED technology provides extremely stable light output over very long periods of time.

These LED lamps are untinted, nondiffused, T-1<sup>3</sup>/<sub>4</sub> packages incorporating second generation

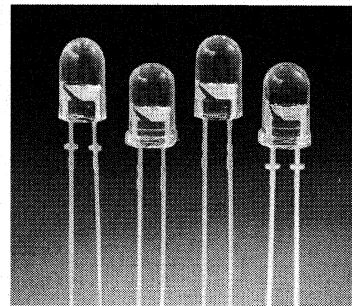

optics producing well defined spatial radiation patterns at specific viewing cone angles.

These lamps are made with an advanced optical grade epoxy, offering superior high temperature and high moisture resistance performance in outdoor signal and sign applications. The high maximum LED junction temperature limit of +130°C enables high temperature operation in bright sunlight conditions. The package epoxy contains both uv-a and uv-b inhibitors to reduce the effects of long term exposure to direct sunlight.

These lamps are available in four package options to give the designer flexibility with device mounting.

## Device Selection Guide

Part Number HLMA-	Viewing Angle, $2\theta^{1/2}$ (Deg.), <sup>[5]</sup> Typ.	Color, Dominant Wavelength, $\lambda_d$ (nm), <sup>[4]</sup> Typ.	Luminous Intensity, $I_v$ (mcd), <sup>[1,2]</sup> @ 20 mA		Total Flux, $\phi_v$ (mlm), <sup>[3]</sup> @ 20 mA, Typ.	Leads with Stand-Offs	Flanged Base	Package Drawing
			Min.	Typ.				
CL20	8	Amber, 590	1600	4000	400	No	Yes	A
GL20	8	Amber, 590	1600	4000	400	No	No	B
CL22	8	Amber, 590	1600	4000	400	Yes	Yes	C
GL22	8	Amber, 590	1600	4000	400	Yes	No	D
CH20	8	Red-Orange, 615	1400	4000	300	No	Yes	A
GH20	8	Red-Orange, 615	1400	4000	300	No	No	B
CH22	8	Red-Orange, 615	1400	4000	300	Yes	Yes	C
GH22	8	Red-Orange, 615	1400	4000	300	Yes	No	D
CL15	15	Amber, 590	700	1700	400	No	Yes	A
GL15	15	Amber, 590	700	1700	400	No	No	B
CL17	15	Amber, 590	700	1700	400	Yes	Yes	C
GL17	15	Amber, 590	700	1700	400	Yes	No	D
CJ15 <sup>[6]</sup>	15	Orange, 605	500	1300	350	No	Yes	A
GJ15 <sup>[6]</sup>	15	Orange, 605	500	1300	350	No	No	B
CJ17 <sup>[6]</sup>	15	Orange, 605	500	1300	350	Yes	Yes	C
GJ17 <sup>[6]</sup>	15	Orange, 605	500	1300	350	Yes	No	D
CH15	15	Red-Orange, 615	500	1300	300	No	Yes	A
GH15	15	Red-Orange, 615	500	1300	300	No	No	B
CH17	15	Red-Orange, 615	500	1300	300	Yes	Yes	C
GH17	15	Red-Orange, 615	500	1300	300	Yes	No	D
CG15	15	Red, 622	290	800	200	No	Yes	A
GG15	15	Red, 622	290	800	200	No	No	B
CG17	15	Red, 622	290	800	200	Yes	Yes	C
GG17	15	Red, 622	290	800	200	Yes	No	D

### Notes:

1. The luminous intensity is measured on the mechanical axis of the lamp package.
2. The optical axis is closely aligned with the package mechanical axis.
3.  $\phi_v$  is the total luminous flux output as measured by an integrating sphere.
4. The dominant wavelength,  $\lambda_d$ , is derived from the CIE Chromaticity Diagram and represents the color of the lamp.
5.  $\theta_{1/2}$  is the off-axis angle where the luminous intensity is one half the on-axis intensity.
6. These 15°, Portland Orange lamps are specifically designed for use in the **HAND** symbol of pedestrian signals.

## Package Dimensions

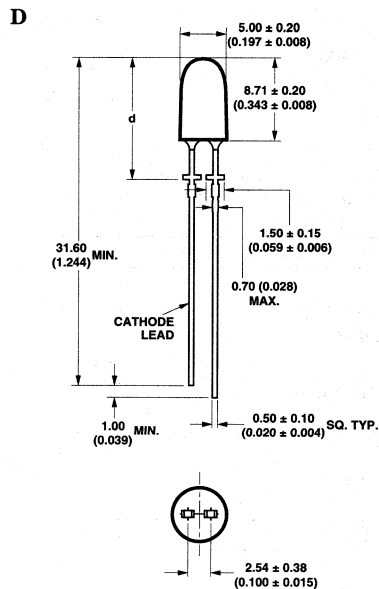
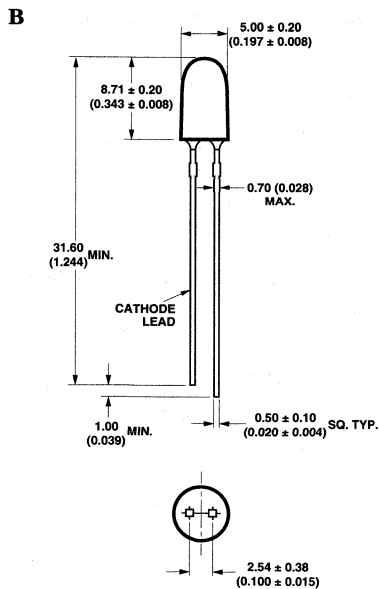
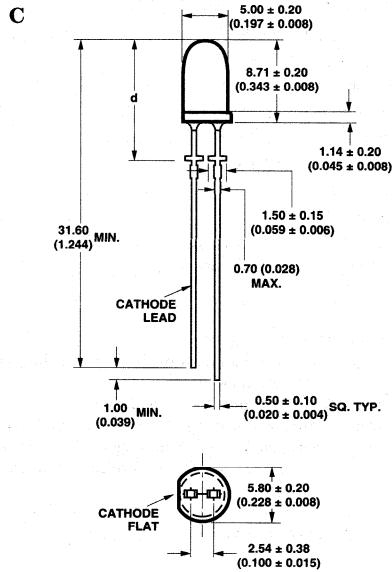
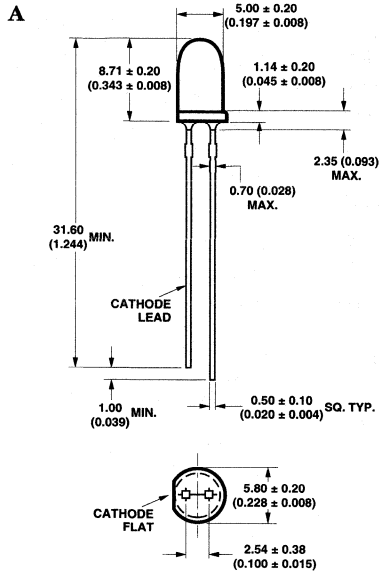

**NOTES:**

1. ALL DIMENSIONS ARE IN MILLIMETERS (INCHES).
2. LEADS ARE MILD STEEL, SOLDER DIPPED.
3. TAPERS SHOWN AT TOP OF LEADS (BOTTOM OF LAMP PACKAGE) INDICATE AN EPOXY MENISCUS THAT MAY EXTEND ABOUT 1 mm (0.040 in.) DOWN THE LEADS.
4. RECOMMENDED PC BOARD HOLE DIAMETERS:
  - LAMP PACKAGES A AND B WITHOUT STAND-OFFS: FLUSH MOUNTING AT BASE OF LAMP PACKAGE = 1.143/1.067 (0.044/0.042).
  - LAMP PACKAGES C AND D WITH STAND-OFFS: MOUNTING AT LEAD STAND-OFFS = 0.965/0.889 (0.038/0.035).
5. FOR DOME HEIGHTS ABOVE LEAD STAND-OFF SEATING PLANE, *d*, LAMP PACKAGES C AND D, SEE TABLE.

PART NO.	<i>d</i>
HLMA-XX22	12.37 ± 0.25 (0.487 ± 0.010)
HLMA-XX17	12.42 ± 0.25 (0.489 ± 0.010)

### Absolute Maximum Ratings at $T_A = 25^\circ\text{C}$

DC Forward Current <sup>[1,2,5,6]</sup> .....	50 mA
Peak Forward Current <sup>[2,3]</sup> .....	200 mA
Average Forward Current (at $I_{PEAK} = 100\text{ mA}$ , $f \geq 1\text{ kHz}$ ) <sup>[3]</sup> .....	45 mA
Transient Forward Current (10 $\mu\text{s}$ Pulse) <sup>[4]</sup> .....	500 mA
Reverse Voltage ( $I_R = 100\ \mu\text{A}$ ) .....	5 V
LED Junction Temperature .....	130°C
Operating Temperature .....	-40°C to +100°C
Storage Temperature .....	-40°C to +120°C
Soldering Temperature .....	260°C for 5 seconds
[1.59 mm (0.060 in.) below seating plane]	

#### Notes:

1. Derate linearly as shown in Figure 4.
2. For long term performance with minimal light output degradation, drive currents at or less than 30 mA are recommended.
3. Refer to Figure 5 for pulsed operating conditions.
4. The transient peak current is the maximum non-recurring pulse over a 10  $\mu\text{s}$  duration that the device can withstand without damage to the LED die or wire bond.
5. Drive currents between 10 mA and 30 mA are recommended for best long term performance.
6. Operation at currents below 10 mA is not recommended, please contact your Hewlett-Packard sales representative.

### Electrical/Optical Characteristics at $T_A = 25^\circ\text{C}$

Parameter	Symbol	Min.	Typ.	Max.	Units	Test Conditions
Forward Voltage	$V_F$		1.9	2.4	V	$I_F = 20\text{ mA}$
Reverse Voltage	$V_R$	5	20		V	$I_R = 100\ \mu\text{A}$
Peak Wavelength:	$\lambda_{PEAK}$		592		nm	Peak of Wavelength Spectral Distribution
Amber ( $\lambda_d = 590\text{ nm}$ )			609			
Portland Orange ( $\lambda_d = 605\text{ nm}$ )			621			
Red-Orange ( $\lambda_d = 615\text{ nm}$ )			630			
Red ( $\lambda_d = 622\text{ nm}$ )						
Spectral Halfwidth:	$\Delta\lambda_{1/2}$		17		nm	Wavelength Width at Spectral Distribution $1/2$ Power Point
Amber			17			
Portland Orange			18			
Red-Orange			20			
Red						
Speed of Response	$\tau_s$		13		ns	Exponential Time Constant, $e^{-t/\tau_s}$
Capacitance	C		40		pF	$V_F = 0$ , $f = 1\text{ MHz}$
Thermal Resistance	$R\theta_{J-PIN}$		237		$^\circ\text{C}/\text{W}$	LED Junction-to-Cathode Lead
Luminous Efficacy <sup>[1]</sup>	$\eta_v$		480		lm/W	Emitted Luminous Power/Emitted Radiant Power
Amber			370			
Portland Orange			263			
Red-Orange			197			
Red						

#### Note:

1. The radiant intensity,  $I_e$ , in watts per steradian, may be found from the equation  $I_e = I_v/\eta_v$ , where  $I_v$  is the luminous intensity in candelas and  $\eta_v$  is the luminous efficacy in lumens/watt.



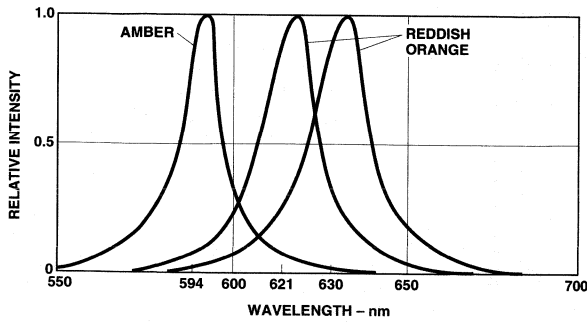

Figure 1. Relative Intensity vs. Wavelength.

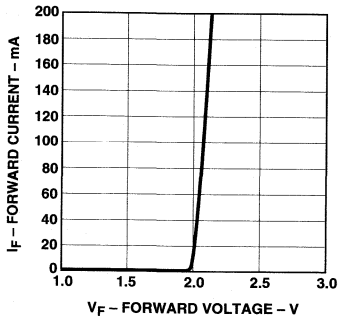

Figure 2. Forward Current vs. Forward Voltage.

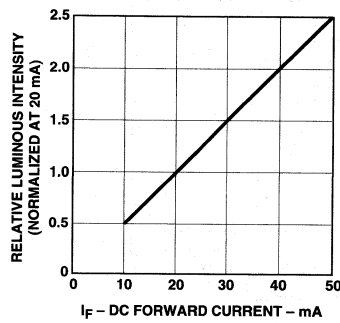

Figure 3. Relative Luminous Intensity vs. Forward Current.

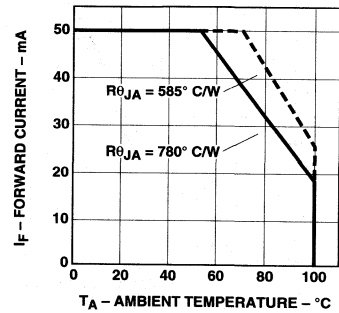

Figure 4. Maximum Forward Current vs. Ambient Temperature. Derating Based on  $T_{JMAX} = 130^{\circ}C$ .

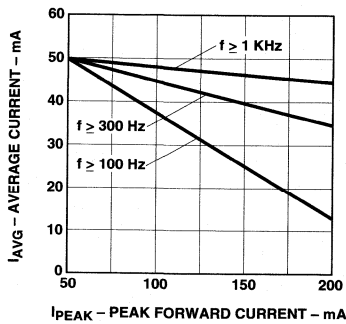

Figure 5. Maximum Average Current vs. Peak Forward Current.

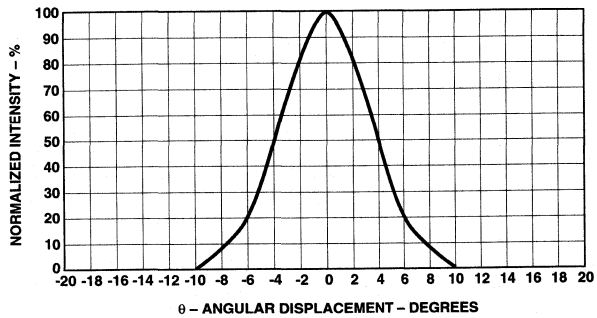

Figure 6. Spatial Radiation Pattern for 8° Viewing Angle Lamps.

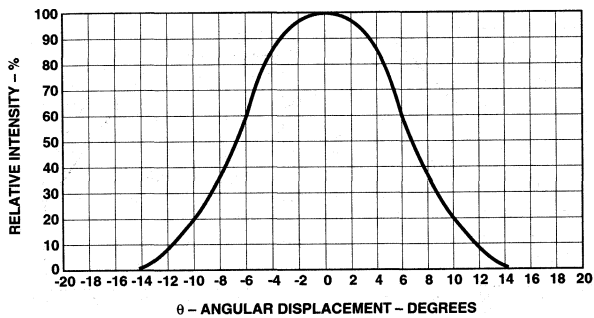

Figure 7. Spatial Radiation Pattern for 15° Viewing Angle Lamps.

---

# T-1<sup>3/4</sup> (5 mm), T-1 (3 mm), High Performance AlInGaP LED Lamps

## Technical Data

**SunPower Series  
HLMA-CX00 Series  
HLMA-DX00 Series  
HLMA-KX00 Series  
HLMT-CX00 Series  
HLMT-DX00 Series**

---

### Features

- **Outstanding LED Material Efficiency**
- **High Light Output over a Wide Range of Currents**
- **Low Electrical Power Dissipation**
- **CMOS/MOS Compatible**
- **Colors: 590/592 nm Amber, 615/617 nm and 622 nm Reddish-Orange**
- **Variety of Packages Available**

### Applications

- **Outdoor Message Boards**
- **Safety Lighting Equipment**
- **Signaling Applications**
- **Emitter for Emitter/Detector Applications**
- **Changeable Message Signs**
- **Portable Equipment**
- **Medical Equipment**
- **Automotive Lighting**
- **Alternative to Incandescent Lamps**

### Description

These untinted, non-diffused, solid state lamps utilize the latest absorbing/transparent substrate aluminum indium gallium phosphide (AS/TS AlInGaP) LED technology. These materials have a very high luminous efficiency, capable of producing high light output over a wide range of drive currents. In addition, these LED lamps are at wavelengths ranging from amber to reddish orange and at viewing angles ranging from 7 to 45 degrees.

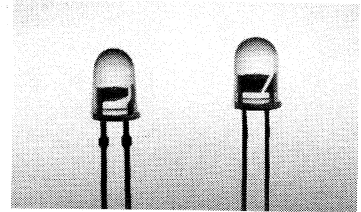

# Package Dimensions

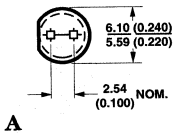
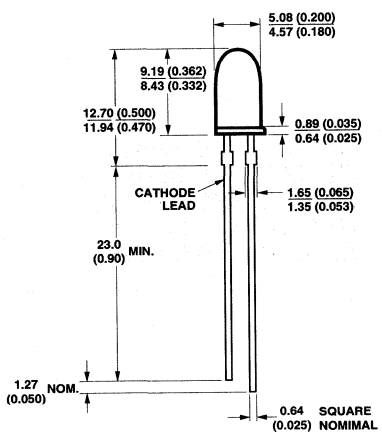

A

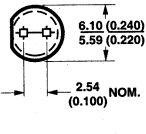
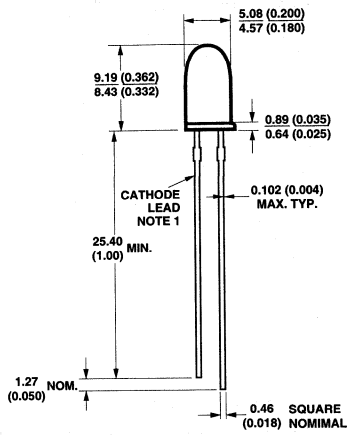

B

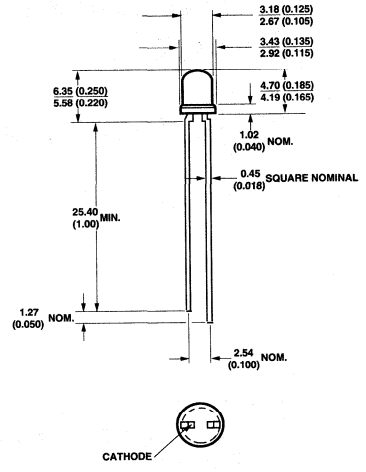

C

- NOTES:  
 1. ALL DIMENSIONS ARE IN MILLIMETERS (INCHES).  
 2. THE LEADS ARE MILD STEEL, SOLDER DIPPED.  
 3. AN EPOXY MENISCUS MAY EXTEND ABOUT 1 MM (0.040") DOWN THE LEADS, UNLESS OTHERWISE NOTED.

**Absolute Maximum Ratings at  $T_A = 25^\circ\text{C}$** **(T-1<sup>3</sup>/<sub>4</sub> Package)**

DC Forward Current <sup>[1,4,5]</sup> .....	50 mA
Peak Forward Current <sup>[2]</sup> .....	200 mA
Time Average Input Power <sup>[2]</sup> .....	103 mW
Transient Forward Current <sup>[3]</sup> (10 $\mu\text{s}$ Pulse) .....	500 mA
Reverse Voltage ( $I_R = 100 \mu\text{A}$ ) .....	5 V
Operating Temperature Range .....	-40 to 100°C
Storage Temperature .....	-40 to 120°C
Junction Temperature .....	130°C
Soldering Temperature .....	260°C for 5 seconds
	[1.59 mm (0.06 in.) below seating plane]

**Notes:**

1. Derate linearly as shown in Figure 4.
2. Any pulsed operation cannot exceed the Absolute Max Peak Forward Current or the Max Allowable Time Average Power as specified in Figure 5.
3. The transient peak current is the maximum nonrecurring peak current the device can withstand without damaging the LED die and wire bonds.
4. Drive Currents between 10 and 30 mA are recommended for best long term performance.
5. Operation at currents below 10 mA is not recommended, please contact your Hewlett-Packard sales representative.

**Absolute Maximum Ratings at  $T_A = 25^\circ\text{C}$  (T-1 Package)**

DC Forward Current <sup>[1,4,5]</sup> .....	50 mA
Peak Forward Current <sup>[2]</sup> .....	200 mA
Time Average Input Power <sup>[2]</sup> .....	103 mW
Transient Forward Current <sup>[3]</sup> (10 $\mu\text{s}$ Pulse) .....	500 mA
Reverse Voltage ( $I_R = 100 \mu\text{A}$ ) .....	5 V
Operating Temperature Range .....	-40 to 100°C
Storage Temperature .....	-40 to 100°C
Junction Temperature .....	110°C
Solder Temperature .....	260°C for 5 seconds
	[1.59 mm (0.06 in.) below seating plane]

**Notes:**

1. Derate linearly as shown in Figure 4.
2. Any pulsed operation cannot exceed the Absolute Max Peak Forward Current or the Max Allowable Time Average Power as specified in Figure 5.
3. The transient peak current is the maximum nonrecurring peak current the device can withstand without damaging the LED die and wire bonds.
4. Drive Currents between 10 mA and 30 mA are recommended for best long term performance.
5. Operation at currents below 10 mA is not recommended, please contact your Hewlett-Packard sales representative.

## Optical Characteristics at $T_A = 25^\circ\text{C}$

### TS-AlInGaP T-1<sup>3/4</sup>

Part Number HLMT-	Luminous Intensity $I_v$ (mcd) @ 20 mA <sup>[1]</sup>		Peak Wavelength $\lambda_{\text{peak}}$ (nm) Typ.	Color, Dominant Wavelength $\lambda_d$ <sup>[2]</sup> (nm) Typ.	Viewing Angle $2\theta_{1/2}$ Degrees <sup>[3]</sup> Typ.	Luminous Efficacy $\eta_v$ (lm/w)	Package Drawing
	Min.	Typ.					
CL00 <sup>[1]</sup>	2600	8300	594	592	8	480	A
CH00 <sup>[1]</sup>	2900	9000	623	617	8	263	
DL00 <sup>[4]</sup>	450	1500	594	592	24	480	B
DH00 <sup>[4]</sup>	500	1800	623	617	24	263	

#### Notes:

1. The luminous intensity,  $I_v$ , is measured at the peak of the spatial radiation pattern which may not be aligned with the mechanical axis of the lamp package.
2. The dominant wavelength,  $\lambda_d$ , is derived from the CIE Chromaticity Diagram and represents the color of the device.
3.  $\theta_{1/2}$  is the off-axis angle where the luminous intensity is 1/2 the peak intensity.
4. The luminous intensity,  $I_v$ , is measured at the mechanical axis of the lamp package. The actual peak of the spatial radiation pattern may not be aligned with this axis.

### AS-AlInGaP T-1<sup>3/4</sup>

Part Number HLMA-	Luminous Intensity $I_v$ (mcd) @ 20 mA <sup>[1]</sup>		Peak Wavelength $\lambda_{\text{peak}}$ (nm) Typ.	Color, Dominant Wavelength $\lambda_d$ <sup>[2]</sup> (nm) Typ.	Viewing Angle $2\theta_{1/2}$ Degrees <sup>[3]</sup> Typ.	Luminous Efficacy $\eta_v$ (lm/w)	Package Drawing
	Min.	Typ.					
CL00 <sup>[1]</sup>	1000	3500	592	590	7	480	A
CH00 <sup>[1]</sup>	1000	3500	621	615	7	263	
DL00 <sup>[4]</sup>	300	800	592	590	24	480	B
DH00 <sup>[4]</sup>	290	600	621	615	24	263	
DG00 <sup>[4]</sup>	290	500	630	622	24	197	

#### Notes:

1. The luminous intensity,  $I_v$ , is measured at the peak of the spatial radiation pattern which may not be aligned with the mechanical axis of the lamp package.
2. The dominant wavelength,  $\lambda_d$ , is derived from the CIE Chromaticity Diagram and represents the color of the device.
3.  $\theta_{1/2}$  is the off-axis angle where the luminous intensity is 1/2 the peak intensity.
4. The luminous intensity,  $I_v$ , is measured at the mechanical axis of the lamp package. The actual peak of the spatial radiation pattern may not be aligned with this axis.

### AS-AlInGaP T-1

Part Number HLMA-	Luminous Intensity $I_v$ (mcd) @ 20 mA <sup>[1]</sup>		Peak Wavelength $\lambda_{\text{peak}}$ (nm) Typ.	Color, Dominant Wavelength $\lambda_d$ <sup>[2]</sup> (nm) Typ.	Viewing Angle $2\theta_{1/2}$ Degrees <sup>[3]</sup> Typ.	Luminous Efficacy $\eta_v$ (lm/w)	Package Drawing
	Min.	Typ.					
KL00	35	200	592	590	45	480	C
KH00	35	200	621	615	45	263	

#### Notes:

1. The luminous intensity,  $I_v$ , is measured at the mechanical axis of the lamp package. The actual peak of the spatial radiation pattern may not be aligned with this axis.
2. The dominant wavelength,  $\lambda_d$ , is derived from the CIE Chromaticity Diagram and represents the color of the device.
3.  $\theta_{1/2}$  is the off-axis angle where the luminous intensity is 1/2 the peak intensity.

**Electrical Characteristics at  $T_A = 25^\circ\text{C}$**

**TS-AlInGaP T-1<sup>3/4</sup>**

Part Number HLMT-	Forward Voltage $V_F$ (Volts) @ $I_F = 20\text{ mA}$		Reverse Breakdown $V_R$ (Volts) @ $I_R = 100\ \mu\text{A}$		Capacitance C (pF) $V_F = 0$ , $f = 1\text{ MHz}$ Typ.	Thermal Resistance $R\theta_{J-PIN}$ ( $^\circ\text{C/W}$ )	Speed of Response $\tau_s$ (ns) Time Constant $e^{-t/\tau_s}$ Typ.
	Typ.	Max.	Min.	Typ.			
CL00	2.0	2.4	5	25	70	210	13
CH00	2.0	2.4	5	25	70	210	13
DL00	2.0	2.4	5	25	70	260	13
DH00	2.0	2.4	5	25	70	260	13

**AS-AlInGaP T-1<sup>3/4</sup>**

Part Number HLMA-	Forward Voltage $V_F$ (Volts) @ $I_F = 20\text{ mA}$		Reverse Breakdown $V_R$ (Volts) @ $I_R = 100\ \mu\text{A}$		Capacitance C (pF) $V_F = 0$ , $f = 1\text{ MHz}$ Typ.	Thermal Resistance $R\theta_{J-PIN}$ ( $^\circ\text{C/W}$ )	Speed of Response $\tau_s$ (ns) Time Constant $e^{-t/\tau_s}$ Typ.
	Typ.	Max.	Min.	Typ.			
CL00	1.9	2.4	5	25	40	210	13
CH00	1.9	2.4	5	25	40	210	13
DL00	1.9	2.4	5	25	40	260	13
DH00	1.9	2.4	5	25	40	260	13
DG00	1.9	2.4	5	25	40	260	13

**AS-AlInGaP T-1**

Part Number HLMA-	Forward Voltage $V_F$ (Volts) @ $I_F = 20\text{ mA}$		Reverse Breakdown $V_R$ (Volts) @ $I_R = 100\ \mu\text{A}$		Capacitance C (pF) $V_F = 0$ , $f = 1\text{ MHz}$ Typ.	Thermal Resistance $R\theta_{J-PIN}$ ( $^\circ\text{C/W}$ )	Speed of Response $\tau_s$ (ns) Time Constant $e^{-t/\tau_s}$ Typ.
	Typ.	Max.	Min.	Typ.			
KL00	1.9	2.4	5	25	40	290	13
KH00	1.9	2.4	5	25	40	290	13

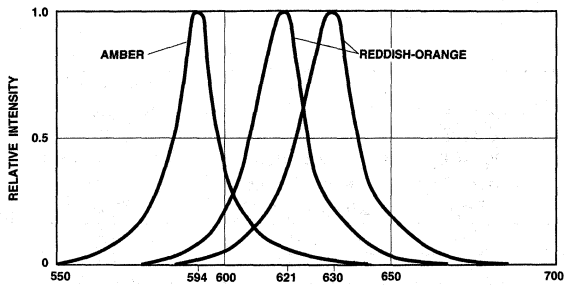

Figure 1. Relative Intensity vs. Wavelength.

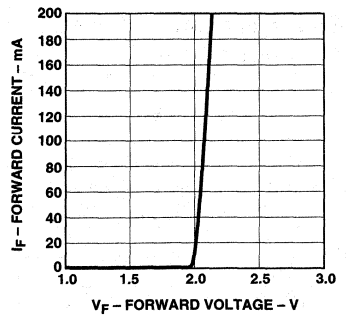

Figure 2a. Forward Current vs. Forward Voltage, AS-AllnGaP.

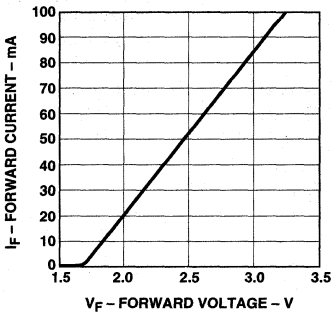

Figure 2b. Forward Current vs. Forward Voltage, TS-AllnGaP.

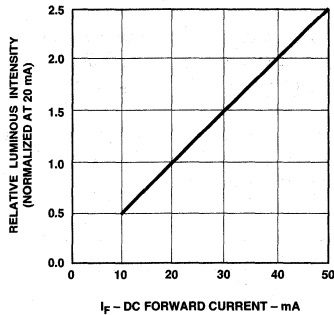

Figure 3. Relative Luminous Intensity vs. Forward Current. Derating Based on  $T_{jMAX}$ .

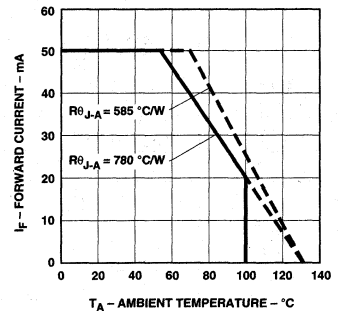

Figure 4a. Maximum DC Current vs. Ambient Temperature for AS T-1<sup>3/4</sup> Lamps. Derating Based on  $T_{jMAX} = 130^{\circ}C$ .

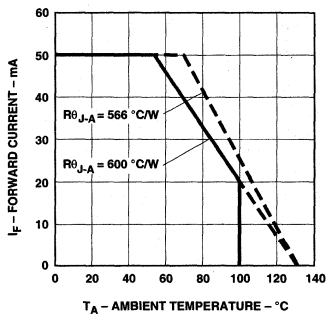

Figure 4b. Maximum DC Current vs. Ambient Temperature for TS T-1<sup>3/4</sup> Lamps. Derating Based on  $T_{jMAX} = 130^{\circ}C$ .

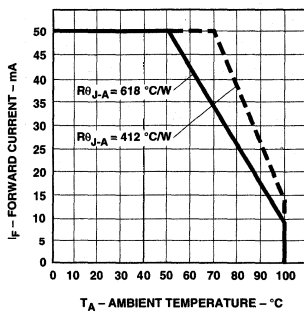

Figure 4c. Maximum Forward Current vs. Ambient Temperature for T-1 Lamps. Derating Based on  $T_{jMAX} = 110^{\circ}C$ .

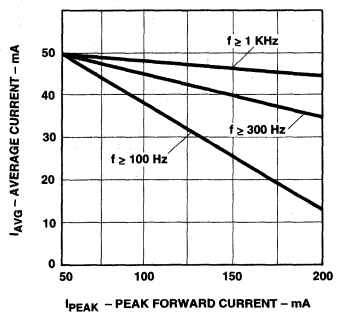

Figure 5. Maximum Average Current vs. Peak Forward Current.



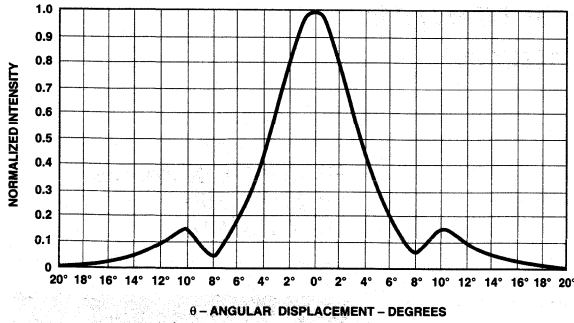

Figure 6. Normalized Luminous Intensity vs. Angular Displacement, HLMT-CH00/CL00.

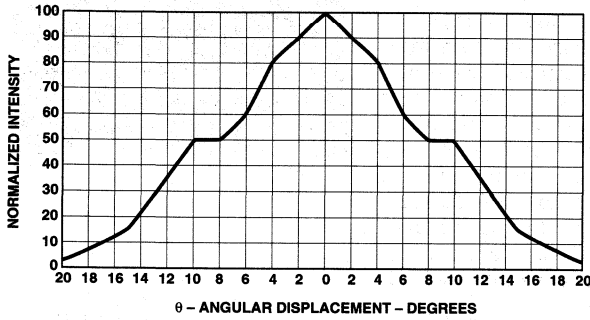

Figure 7. Normalized Luminous Intensity vs. Angular Displacement, HLMA-DG00/-DH00/-DL00.

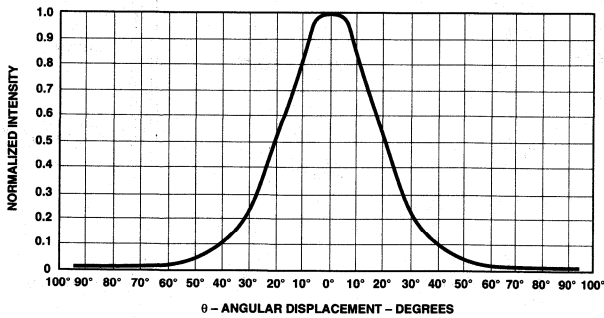

Figure 8. Normalized Luminous Intensity vs. Angular Displacement, HLMA-KH00/-KL00.

# T-1<sup>3</sup>/<sub>4</sub> (5 mm) High Performance TS AlGaAs Red LED Lamps

## Technical Data

**HLMP-810X Series**  
**HLMP-C100**  
**HLMP-C110**

### Features

- Exceptional Brightness
- Outstanding LED Material Efficiency
- High Light Output Over a Wide Range of Drive Currents
- Viewing Angle: Narrow or Wide
- Low Forward Voltage
- Low Power Dissipation
- CMOS/MOS Compatible
- Red Color

### Description

These T-1<sup>3</sup>/<sub>4</sub>, untinted, nondiffused lamps utilize a highly optimized LED material technology, transparent substrate aluminum gallium arsenide (TS AlGaAs). This LED technology has a very high luminous efficiency, capable of producing high light output over a wide range of drive currents (500 μA to 50 mA). The color is deep red at a dominant wavelength of 644 nm. TS AlGaAs is a flip-chip LED technology, die attached to the anode lead and wire bonded to the cathode lead.

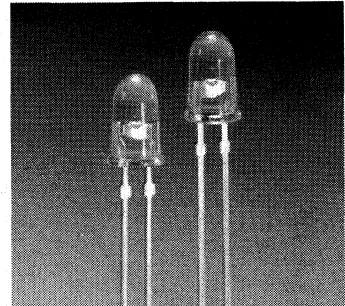

### Package Dimensions

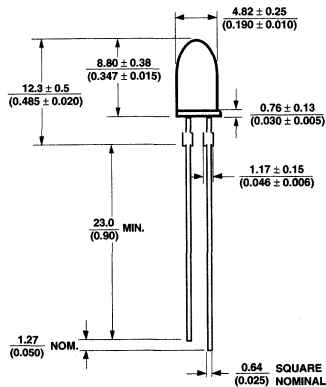

HLMP-8100

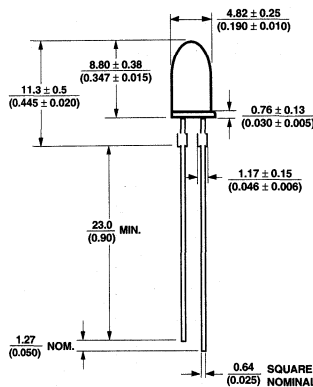

HLMP-8102/8103

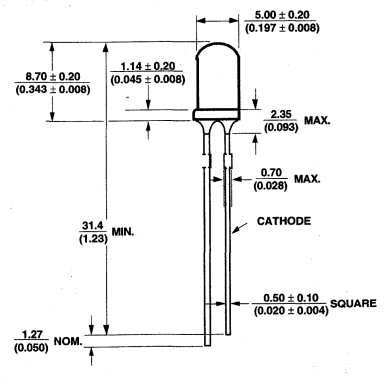

HLMP-C100/C110

- NOTES:  
 1. ALL DIMENSIONS ARE IN MILLIMETERS/INCHES.  
 2. THE LEADS ARE MILD STEEL, SOLDER DIPPED.  
 3. AN EPOXY MENISCUS MAY EXTEND ABOUT 1 mm (0.040") DOWN THE LEADS, UNLESS OTHERWISE NOTED.

### Axial Luminous Intensity and Viewing Angle at $T_A = 25^\circ\text{C}$

Part Number HLMP-	Minimum Intensity (mcd) @ 20 mA	Typical Intensity (mcd) @ 20 mA	Typical Radiant Intensity (mW/sr) @ 20 mA	$2\theta^{1/2}$ <sup>[1]</sup> Degrees
8103	2000	3000	35.3	7
8102	1400	2000	23.5	7
8100	290	1000	11.8	19
C100	290	750	8.8	30
C110	200	400	4.7	40

**Note:**

1.  $\theta^{1/2}$  is the off axis angle from optical centerline where the luminous intensity is 1/2 the on-axis value.

### Absolute Maximum Ratings at $T_A = 25^\circ\text{C}$

Peak Forward Current <sup>[2]</sup> .....	300 mA
Average Forward Current (@ $I_{PEAK} = 300\text{ mA}$ ) <sup>[1,2]</sup> .....	30 mA
DC Forward Current <sup>[3]</sup> .....	50 mA
Power Dissipation .....	100 mW
Reverse Voltage ( $I_R = 100\ \mu\text{A}$ ) .....	5 V
Transient Forward Current (10 $\mu\text{s}$ Pulse) <sup>[4]</sup> .....	500 mA
Operating Temperature Range .....	-55 to +100°C
Storage Temperature Range .....	-55 to +100°C
LED Junction Temperature .....	110°C
Lead Soldering Temperature [1.6 mm (0.063 in.) from body] .....	260°C for 5 seconds

**Notes:**

1. Maximum  $I_{AVG}$  at  $f = 1\text{ kHz}$ ,  $DF = 10\%$ .
2. Refer to Figure 6 to establish pulsed operating conditions.
3. Derate linearly as shown in Figure 5.
4. The transient peak current is the maximum non-recurring peak current the device can withstand without damaging the LED die and wire bonds. It is not recommended that the device be operated at peak currents above the Absolute Maximum Peak Forward Current.

## Electrical/Optical Characteristics at $T_A = 25^\circ\text{C}$

Description	Symbol	Min.	Typ.	Max.	Units	Test Conditions
Forward Voltage	$V_F$		1.85	2.4	V	$I_F = 20 \text{ mA}$
Reverse Voltage	$V_R$	5.0	20.0		V	$I_R = 100 \mu\text{A}$
Peak Wavelength	$\lambda_{\text{PEAK}}$		654		nm	
Dominant Wavelength <sup>[1]</sup>	$\lambda_d$		644		nm	
Spectral Line Halfwidth	$\Delta\lambda/2$		18		nm	
Speed of Response	$\tau_s$		45		ns	Exponential Time Constant, $e^{-t/\tau}$
Capacitance	C		20		pF	$V_F = 0, f = 1 \text{ MHz}$
Thermal Resistance HLMP-810X	$R\theta_{J-PIN}$		210		$^\circ\text{C/W}$	Junction-to-Anode Lead
HLMP-C1X0			237			
Luminous Efficacy <sup>[2]</sup>	$\eta_v$		85		lm/W	

### Notes:

1. The dominant wavelength,  $\lambda_d$ , is derived from the CIE chromaticity diagram and represents the color of the device.
2. The radiant intensity,  $I_e$ , in watts per steradian, may be found from the equation  $I_e = I_v / \eta_v$ , where  $I_v$  is the luminous intensity in candelas and  $\eta_v$  is luminous efficacy in lumens/watt

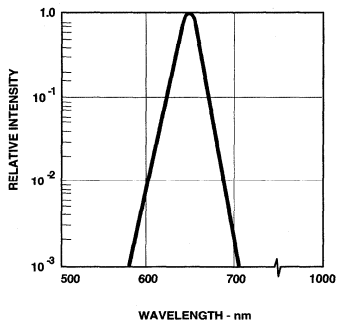

Figure 1. Relative Intensity vs. Wavelength.

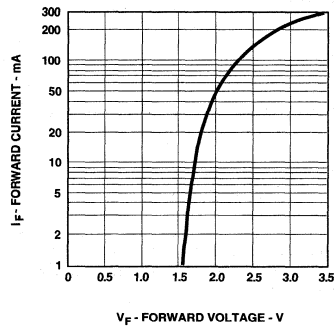

Figure 2. Forward Current vs. Forward Voltage.

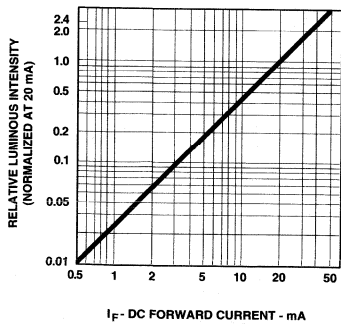

Figure 3. Relative Luminous Intensity vs. DC Forward Current.

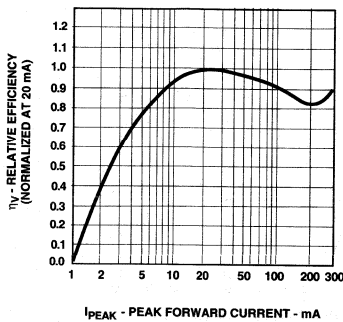

Figure 4. Relative Efficiency vs. Peak Forward Current.

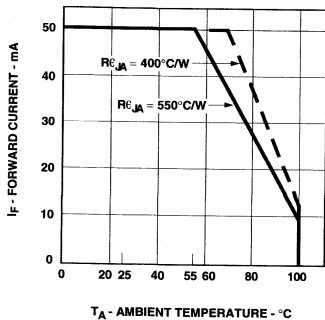

Figure 5. Maximum Forward DC Current vs. Ambient Temperature. Derating Based on  $TJ_{MAX} = 110^\circ\text{C}$ .

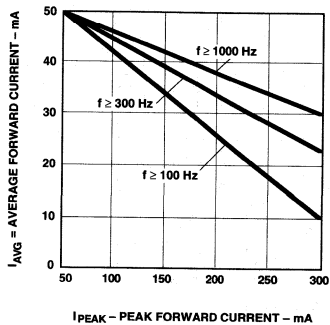

Figure 6. Maximum Average Current vs. Peak Forward Current.

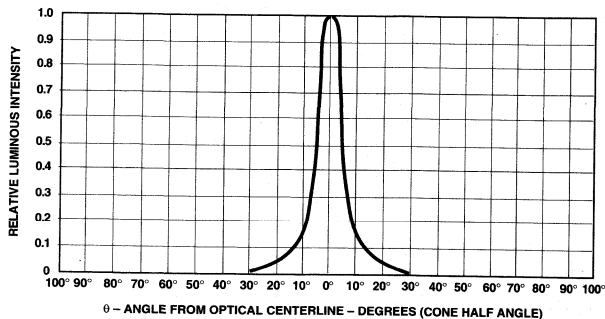
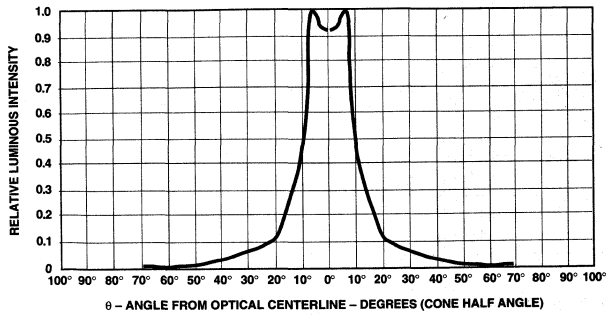
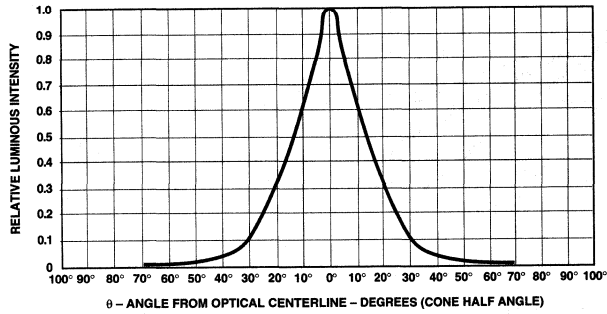

Figure 7. Relative Luminous Intensity vs. Angular Displacement. HLMP-8103 and HLMP-8102.



**Figure 8. Relative Luminous Intensity vs. Angular Displacement. HLMP-8100.**



**Figure 9. Relative Luminous Intensity vs. Angular Displacement. HLMP-C100.**

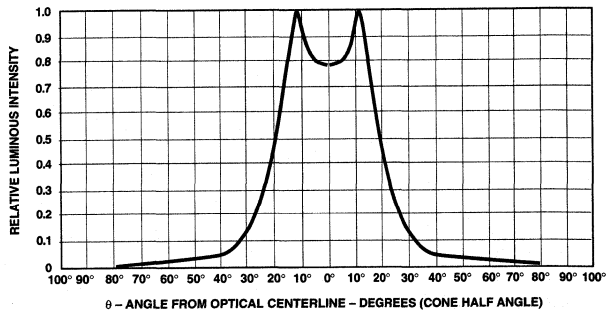

**Figure 10. Relative Luminous Intensity vs. Angular Displacement. HLMP-C110.**

# T-1<sup>3/4</sup> (5 mm), T-1 (3 mm), High Performance, Tinted, Diffused, AlInGaP, and TS AlGaAs Red LED Lamps

## Technical Data

**HLMA-DX05 Series**  
**HLMA-KX05 Series**  
**HLMP-D1XX Series**  
**HLMP-J100/J150 Series**

### Features

- High Light Output Over a Wide Range of Currents
- Popular T-1 and T-1<sup>3/4</sup> Packages
- Choice of Three Colors  
 Amber  
 Reddish-Orange  
 Deep Red
- Wide Viewing Angles
- Long Life: Solid State Technology
- Available on Tape and Reel

### Applications

- Outdoor Message Boards
- Automotive Lighting
- Portable Equipment
- Medical Equipment
- Changeable Message Signs

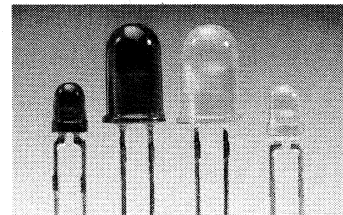

### Description

The HLMA-D/KXXX series tinted, diffused, solid state lamps utilize the newly developed aluminum indium gallium phosphide (AlInGaP) LED technology. This technology has a very high luminous efficiency, capable of producing high light output over a wide range of drive currents. These LED lamps are available with a choice of two colors, 592

nm amber and 615 nm reddish-orange, and with two viewing angles, 65° and 60°.

The HLMP-D/JXXX series tinted, diffused solid state lamps utilize the highly optimized transparent substrate aluminum gallium arsenide (TS AlGaAs) LED technology. This technology has a very high luminous efficiency,

### Device Selection Guide

Package Description	Viewing Angle 2θ <sub>1/2</sub>	Amber λ <sub>d</sub> = 592 nm	Reddish-Orange λ <sub>d</sub> = 615 nm	Deep Red λ <sub>d</sub> = 644 nm	Package Outline
T-1 <sup>3/4</sup> (5 mm), Tinted, Diffused, Standard Current	65°	HLMA-DL05	HLMA-DH05		A
T-1 (3 mm), Tinted, Diffused, Standard Current	60°	HLMA-KL05	HLMA-KH05		B
T-1 <sup>3/4</sup> (5 mm), Tinted, Diffused, Standard Current	40°			HLMP-D115	A
T-1 <sup>3/4</sup> (5 mm), Tinted, Diffused, Standard Current	25°			HLMP-D120	A
T-1 (3 mm), Tinted, Diffused, Standard Current	55°			HLMP-J100	C
T-1 (3 mm), Tinted, Diffused, Diffused, Low Current	55°			HLMP-J150	C

capable of producing high light output over the wide range of drive currents from 500  $\mu$ A to 50 mA. The color is deep red at a

dominant wavelength of 644 nm. TS AlGaAs is a flip-chip LED technology, die attached to the anode lead and wire bonded to

the cathode lead. Available viewing angles are 25°, 40°, and 55°.

### Package Dimensions

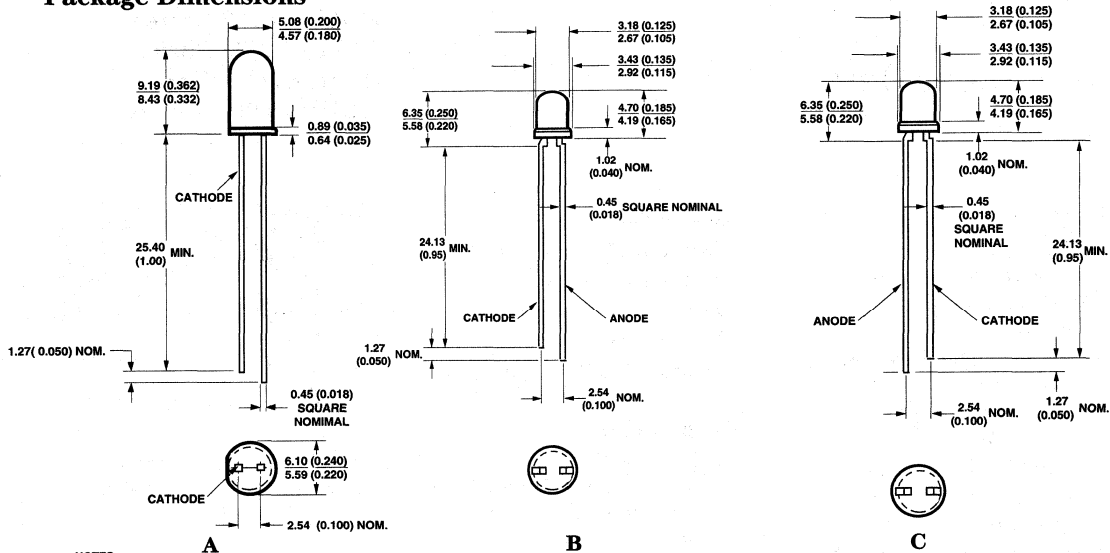

- NOTES:  
 1. ALL DIMENSIONS ARE IN MILLIMETERS (INCHES).  
 2. AN EPOXY MENISCUS MAY EXTEND ABOUT 1 mm (0.040") DOWN THE LEADS.

### HLMA-DL05/DH05/KI05/KH05 AllnGaP Lamps

#### Absolute Maximum Ratings at $T_A = 25^\circ\text{C}$

Parameter	HLMA-DL05	HLMA-DH05	HLMA-KL05	HLMA-KH05	Units
DC Forward Current <sup>[1,3,4]</sup>	50	50	50	50	mA
Peak Forward Current <sup>[2]</sup>	200	200	200	200	mA
Average Input Power <sup>[2]</sup>	103	103	103	103	mW
Reverse Voltage ( $I_R = 100 \mu\text{A}$ )	5	5	5	5	V
Operating Temperature Range	-40 to +100	-40 to +100	-40 to +100	-40 to +100	$^\circ\text{C}$
Storage Temperature Range	-55 to +100	-55 to +100	-55 to +100	-55 to +100	$^\circ\text{C}$
Junction Temperature	110				$^\circ\text{C}$
Soldering Temperature [1.59 mm (0.06 in.) below seating plane]	260 $^\circ\text{C}$ for 5 second				

**Notes:**

- Derate linearly as shown in Figure 4.
- Any pulsed operation cannot exceed the Absolute Max Peak Forward current as specified in Figure 5.
- Drive currents between 10 mA and 30 mA are recommended for best long term performance.
- Operation at currents below 10 mA is not recommended, please contact your Hewlett-Packard sales representative.



### Optical Characteristics at $T_A = 25^\circ\text{C}$

Part Number HLMA-	Luminous Intensity $I_V$ (mcd) @ 20 mA <sup>[1]</sup>		Peak Wavelength $\lambda_{\text{peak}}$ (nm) Typ.	Color, Dominant Wavelength $\lambda_d$ <sup>[2]</sup> (nm) Typ.	Viewing Angle $2\theta^{1/2}$ Degrees <sup>[3]</sup> Typ.	Luminous Efficacy $\eta_v$ (lm/w)
	Min.	Typ.				
DL05	35	100	594	592	65	480
DH05	35	100	621	615	65	263
KL05	35	100	594	592	60	480
KH05	35	100	621	615	60	263

**Notes:**

- $\phi_v$  is the total luminous flux output as measured with an integrating sphere.
- The dominant wavelength,  $\lambda_d$ , is derived from the CIE Chromaticity Diagram and represents the color of the device.
- $\theta^{1/2}$  is the off-axis angle where the luminous intensity is 1/2 the peak intensity.

### Electrical Characteristics at $T_A = 25^\circ\text{C}$

Part Number HLMA-	Forward Voltage $V_F$ (Volts) @ $I_F = 20$ mA		Reverse Breakdown $V_R$ (Volts) @ $I_R = 100$ $\mu\text{A}$		Capacitance C (pF) $V_F = 0$ , $f = 1$ MHz Typ.	Thermal Resistance $R\theta_{J-PIN}$ ( $^\circ\text{C}/\text{W}$ )	Speed of Response $\tau_s$ (ns) Time Constant $e^{-t/\tau_s}$ Typ.
	Typ.	Max.	Min.	Typ.			
DL05	1.9	2.4	5	25	60	260	13
DH05	1.9	2.4	5	25	60	260	13
KL05	1.9	2.4	5	25	60	290	13
KH05	1.9	2.4	5	25	60	290	13

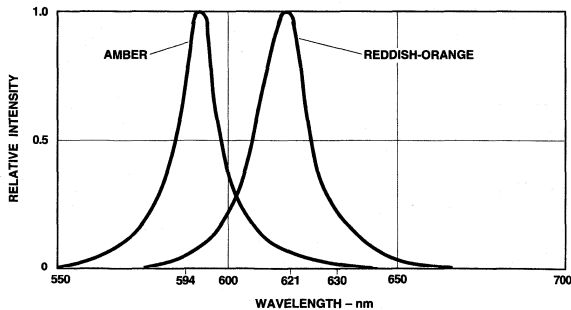

Figure 1. Relative Intensity vs. Wavelength.

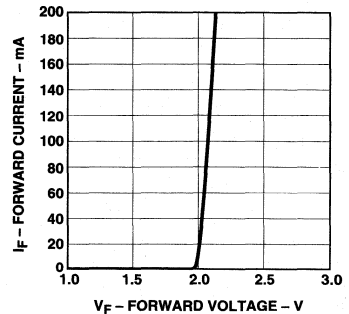

Figure 2. Forward Current vs. Forward Voltage.

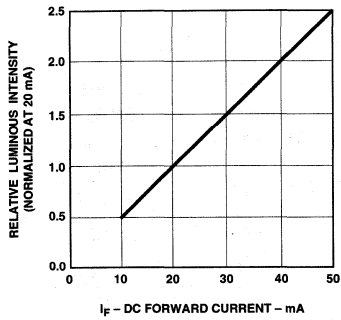

Figure 3. Relative Luminous Intensity vs. Forward Current.

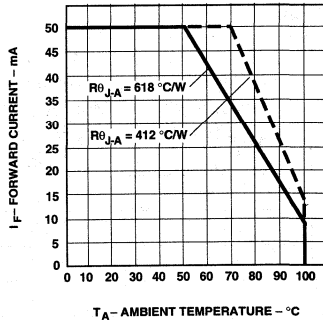

Figure 4. Maximum Forward Current vs. Ambient Temperature. Derating Based on  $T_J$  Max = 110°C.

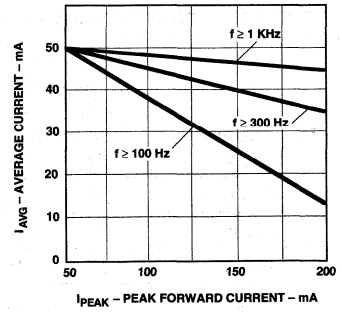

Figure 5. Maximum Average Current vs. Peak Forward Current.

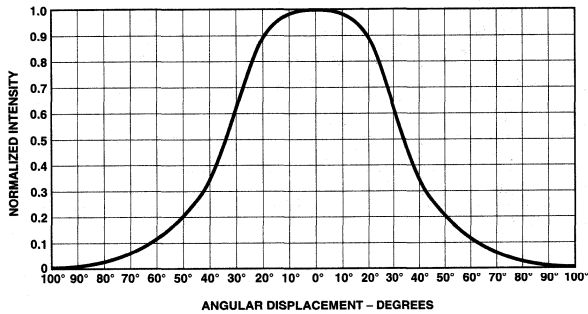

Figure 6. Spatial Radiation Pattern for HLMA-DL05/DH05 65° Lamps.

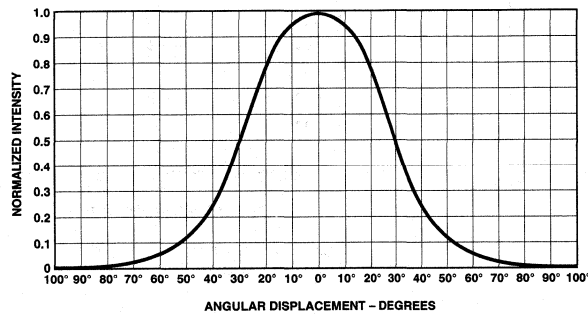

Figure 7. Spatial Radiation Pattern for HLMA-KL05/KH05 60° Lamps.

## HLMP-D115/D120/J100/J150 TS AlGaAs Red Lamps Absolute Maximum Ratings at $T_A = 25^\circ\text{C}$

Parameter	HLMP-D115	HLMP-D120	HLMP-J100	HLMP-J150	Units
DC Forward Current <sup>[1]</sup>	50	50	50	50	mA
Peak Forward Current <sup>[2]</sup>	300	300	300	300	mA
Average Input Power <sup>[2]</sup>	100	100	100	100	mW
Reverse Voltage ( $I_R = 100 \mu\text{A}$ )	5	5	5	5	V
Operating Temperature Range	-55 to +100	-55 to +100	-55 to +100	-55 to +100	$^\circ\text{C}$
Storage Temperature Range	-55 to +100	-55 to +100	-55 to +100	-55 to +100	$^\circ\text{C}$
Junction Temperature	110				$^\circ\text{C}$
Soldering Temperature [1.59 mm (0.06 in.) below seating plane]	260 $^\circ\text{C}$ for 5 second				

**Notes:**

- Derate linearly as shown in Figure 12.
- Any pulsed operation cannot exceed the Absolute Max Peak Forward current as specified in Figure 13.

## Optical Characteristics at $T_A = 25^\circ\text{C}$

Part Number HLMP-	Luminous Intensity $I_V$ (mcd) @ 20 mA <sup>[1]</sup>		Peak Wavelength $\lambda_{\text{peak}}$ (nm) Typ.	Color, Dominant Wavelength $\lambda_d$ <sup>[2]</sup> (nm) Typ.	Viewing Angle $2 \theta_{1/2}$ Degrees <sup>[3]</sup> Typ.	Luminous Efficacy $\eta_V$ (lm/w)
	Min.	Typ.				
D115	138	250	654	644	40	85
D120	138	350	654	644	25	85
J100	39	175	654	644	55	85
J150	1.3	3.0	654	644	55	85

**Notes:**

- $\phi_v$  is the total luminous flux output as measured with an integrating sphere.
- The dominant wavelength,  $\lambda_d$ , is derived from the CIE Chromaticity Diagram and represents the color of the device.
- $\theta_{1/2}$  is the off-axis angle where the luminous intensity is 1/2 the peak intensity.

## Electrical Characteristics at $T_A = 25^\circ\text{C}$

Part Number HLMP-	Forward Voltage $V_F$ (Volts) @ $I_F = 20 \text{ mA}$		Reverse Breakdown $V_R$ (Volts) @ $I_R = 100 \mu\text{A}$		Capacitance C (pF) $V_F = 0$ $f = 1 \text{ MHz}$ Typ.	Thermal Resistance $R\theta_{J-PIN}$ ( $^\circ\text{C}/\text{W}$ )	Speed of Response $\tau_s$ (ns) Time Constant $e^{-t/\tau_s}$ Typ.
	Min.	Typ.	Min.	Typ.			
D115	1.85	2.4	5	20	20	260	45
D120	1.85	2.4	5	20	20	260	45
J100	1.85	2.4	5	20	20	290	45
J150	1.6	1.9	5	20	20	290	45

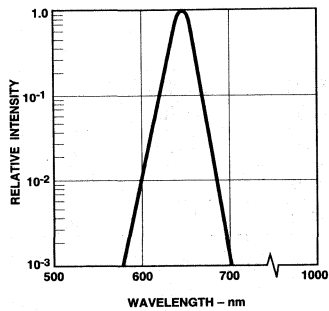

Figure 8. Relative Intensity vs. Wavelength.

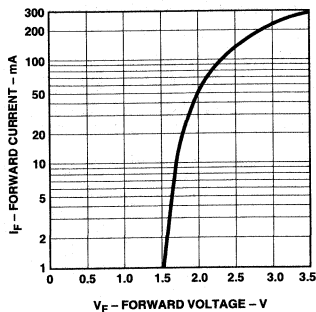

Figure 9. Forward Current vs. Forward Voltage.

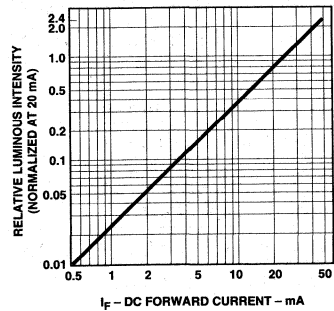

Figure 10. Relative Luminous Intensity vs. DC Forward Current.

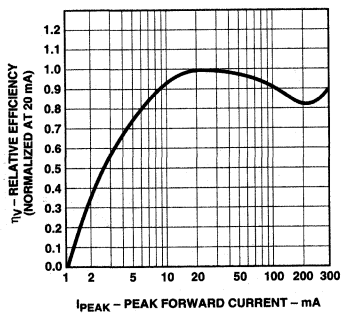

Figure 11. Relative Efficiency vs. Peak Forward Current.

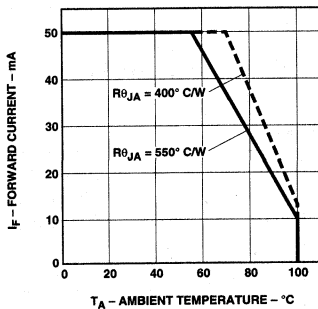

Figure 12. Maximum Forward Current vs. Ambient Temperature. Derating Based on  $T_j \text{ Max} = 110^\circ\text{C}$ .

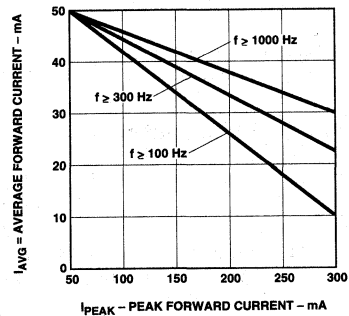

Figure 13. Maximum Average Current vs. Peak Forward Current.

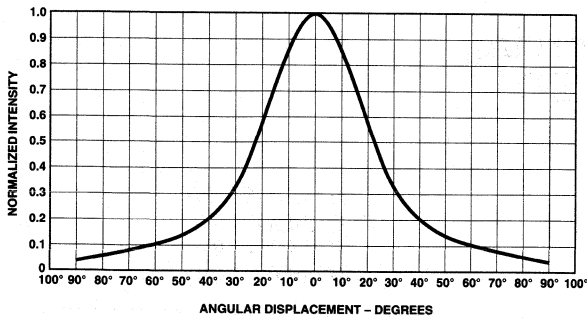

Figure 14. Spatial Radiation Pattern for 40° HLMP-D115 Lamp.

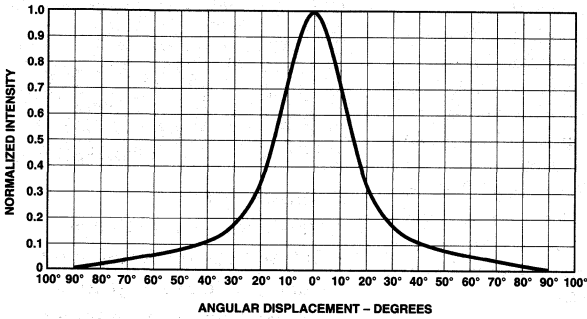

Figure 15. Spatial Radiation Pattern for 25° HLMP-D120 Lamp.

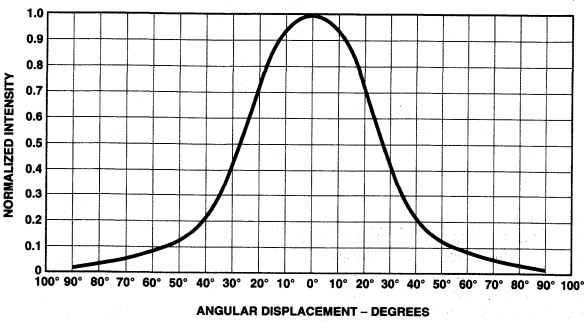

Figure 16. Spatial Radiation Pattern for 55° HLMP-J100-J150 Lamps.

# T-13/4 (5 mm), Wide Viewing Angle, High Intensity LED Lamps

## Technical Data

**HLMA-VH00**  
**HLMA-VL00**  
**HLMP-V100**  
**HLMP-V500**

### Features

- **Outstanding LED Material Efficiency**
- **Extremely Wide Horizontal Viewing Angle**
- **High Light Output over a Wide Range of Currents**
- **Untinted, Non-diffused Lens**
- **Choice of Four Colors: 644 nm Red, 590 nm Amber, 570 nm Green, and 615 nm Orange**

### Description

These high intensity LED lamps provide the user with an extremely wide 60° (horizontal) by 30° (vertical) oval shaped radiation pattern. Available in TS AlGaAs red, AlInGaP orange, AlInGaP orange, and GaP green colors, these untinted non-diffused T-1<sup>3</sup>/<sub>4</sub> (5 mm) LEDs are an excellent choice for outdoor applications requiring an extremely wide field of vision and high brightness.

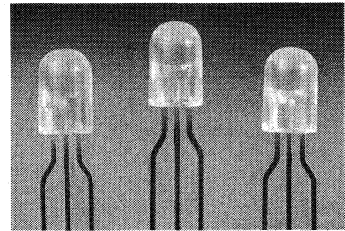

### Applications

- **Outdoor Message Boards**
- **Safety Lighting Equipment**
- **Changeable Message Signs**
- **Alternative to Incandescent Lamps**

### Outline Drawing

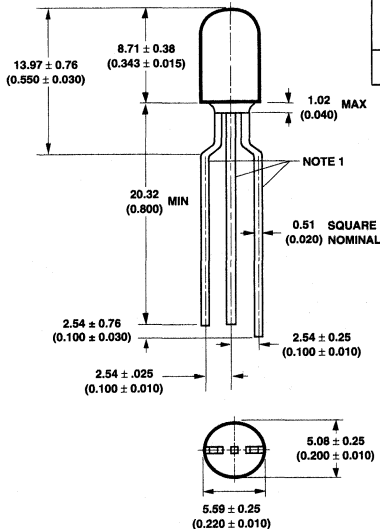

### Device Selection Guide

Amber $\lambda_d = 590 \text{ nm}$	Red-Orange $\lambda_d = 615 \text{ nm}$	Red $\lambda_d = 644 \text{ nm}$	Green $\lambda_d = 570 \text{ nm}$
HLMA-VL00	HLMA-VH00	HLMP-V100	HLMP-V500

#### NOTES:

##### 1. LEAD ORIENTATION:

DEVICE TYPE	CENTER LEAD	OUTER LEADS
HLMP-V100	COMMON ANODE	CATHODE
HLMP-V500	COMMON CATHODE	ANODE
HLMA-VL00	COMMON CATHODE	ANODE
HLMA-VH00	COMMON CATHODE	ANODE

##### 2. ALL DIMENSIONS ARE IN MM (INCHES).

### Absolute Maximum Ratings at $T_A = 25^\circ\text{C}$

Parameter	HLMA-VL00	HLMA-VH00	HLMP-V100	HLMP-V500	Units
DC Forward Current <sup>[1,3]</sup>	60 <sup>[4,5]</sup>	60 <sup>[4,5]</sup>	60	50	mA
Peak Forward Current <sup>[2,3]</sup>	400	400	600	180	mA
Average Input Power <sup>[2]</sup>	120	120	120	110	mW
Reverse Voltage ( $I_R = 200 \mu\text{A}$ )	5	5	5	5	V
Operating Temperature Range	-40 to +100	-40 to +100	-55 to +85	-20 to +100	$^\circ\text{C}$
Storage Temperature Range	-55 to +100	-55 to +100	-55 to +100	-55 to +100	$^\circ\text{C}$
Junction Temperature	110				$^\circ\text{C}$
Soldering Temperature [1.59 mm (0.06 in.) below seating plane]	260 $^\circ\text{C}$ for 5 seconds				

#### Notes:

- Derate linearly as shown in Figure 5.
- Any pulsed operation cannot exceed the Absolute Max Peak Forward Current or the Max Allowable Average Power as specified in Figure 6.
- Specified with both die powered simultaneously.
- Drive Currents between 10 mA and 30 mA are recommended for best long term performance.
- Operation at currents below 10 mA is not recommended, please contact your Hewlett-Packard sales representative.

### Optical Characteristics at $T_A = 25^\circ\text{C}$

Part Number	Luminous Intensity $I_V$ (mcd) @ 40 mA <sup>[1]</sup>		Peak Wavelength $\lambda_{\text{peak}}$ (nm) Typ.	Color, Dominant Wavelength $\lambda_d$ <sup>[2]</sup> (nm) Typ.	Viewing Angle $2\theta_{1/2}$ Degrees <sup>[3]</sup> Typ.	Luminous Efficacy $\eta_V$ (lm/w)
	Min.	Typ.				
HLMA-VL00	212	460	592	590	60° horizontal 30° vertical	480
HLMA-VH00	200	460	621	615		263
HLMP-V100	500	1000	654	644	60° horizontal 30° vertical	85
HLMP-V500	112	270	568	570	60° horizontal 30° vertical	595

#### Notes:

- The luminous intensity,  $I_V$ , is measured at the mechanical axis of the lamp package. The actual peak of the spatial radiation pattern may not be aligned with this axis.
- The dominant wavelength,  $\lambda_d$ , is derived from the CIE Chromaticity Diagram and represents the color of the device.
- $2\theta_{1/2}$  is the off-axis angle where the luminous intensity is 1/2 the on-axis intensity.

### Electrical Characteristics at $T_A = 25^\circ\text{C}$

Part Number	Forward Voltage $V_F$ (Volts) @ $I_F = 40 \text{ mA}$		Reverse Breakdown $V_R$ (Volts) @ $I_R = 200 \mu\text{A}$ Min.	Capacitance C (pF) $V_F = 0$ , $f = 1 \text{ MHz}$ Typ.	Thermal Resistance $R\theta_{J-PIN}$ ( $^\circ\text{C}/\text{W}$ )	Speed of Response $\tau_r$ (ns) Time Constant $e^{-t/\tau_s}$ Typ.
	Typ.	Max.				
HLMA-VL00	1.90	2.4	5	120	100	13
HLMA-VH00	1.90	2.4	5	120	100	13
HLMP-V100	1.85	2.4	5	50	115	26
HLMP-V500	2.20	3.0	5	20	100	171

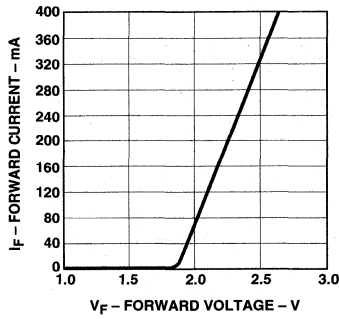

Figure 2a. Forward Current vs. Forward Voltage, HLMA-VL00/VH00.

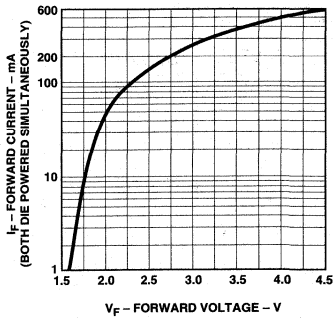

Figure 2b. Forward Current vs. Forward Voltage, HLMP-V100.

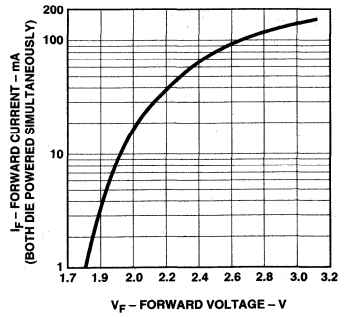

Figure 2c. Forward Current vs. Forward Voltage, HLMP-V500.

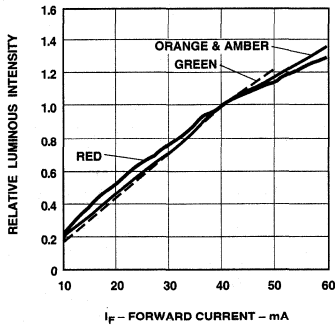

Figure 3. Relative Luminous Intensity vs. Forward Current.

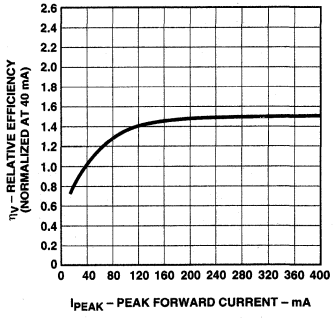

Figure 4a. Relative Efficiency vs. Peak Forward Current, HLMA-VL00/VH00.

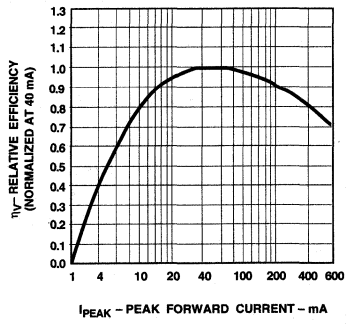

Figure 4b. Relative Efficiency vs. Peak Forward Current, HLMP-V100.

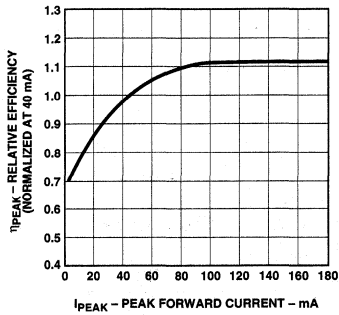

Figure 4c. Relative Efficiency vs. Peak Forward Current, HLMP-V500.

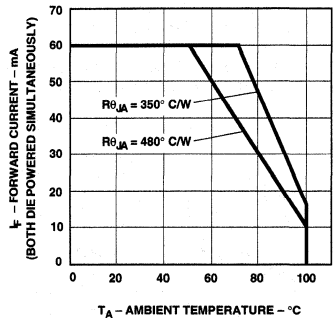

Figure 5a. Maximum Forward DC Current vs. Ambient Temperature, HLMA-VL00/VH00.

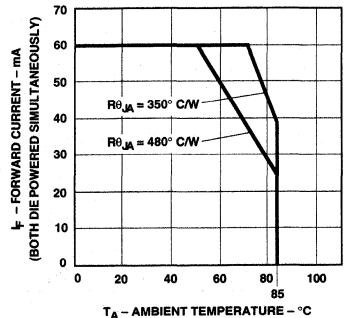

Figure 5b. Maximum Forward DC Current vs. Ambient Temperature, HLMP-V100.



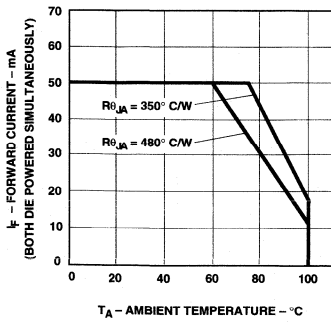

Figure 5c. Maximum Forward DC Current vs. Ambient Temperature, HLMP-V500.

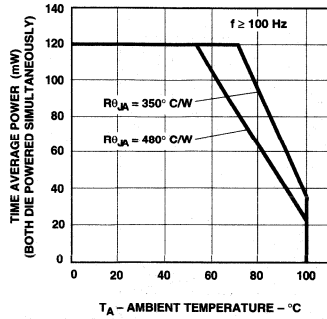

Figure 6a. Maximum Allowable Average Power vs. Ambient Temperature, HLMA-VL00/VH00.

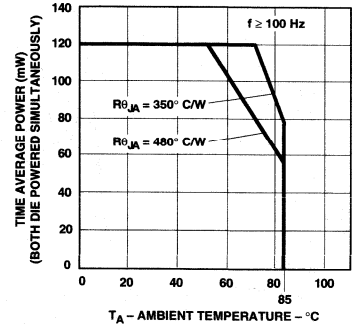

Figure 6b. Maximum Allowable Average Power vs. Ambient Temperature, HLMP-V100.

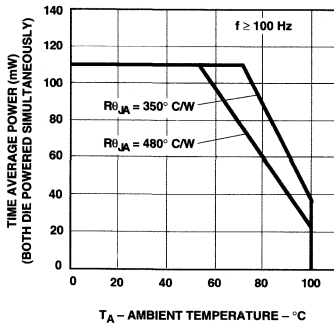

Figure 6c. Maximum Allowable Average Power vs. Ambient Temperature, HLMP-V500.

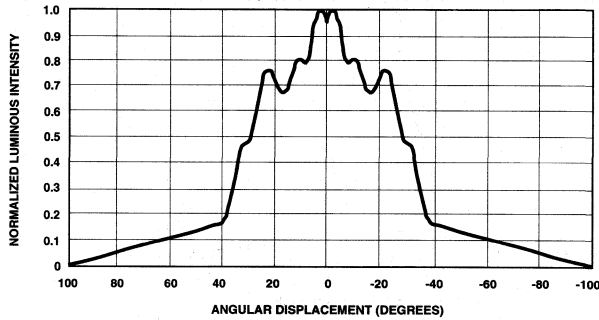

Figure 7a. Relative Intensity vs. Angle, HLMA-VL00/VH00 Horizontal Axis.

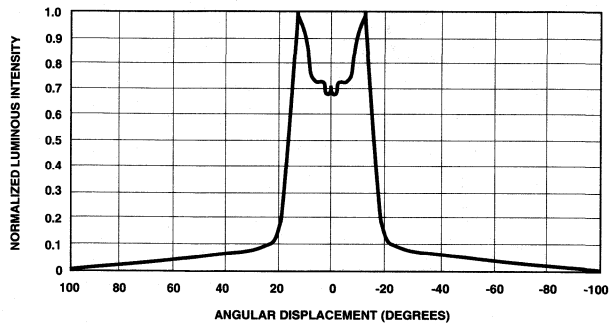

Figure 7b. Relative Intensity vs. Angle, HLMA-VL00/VH00 Vertical Axis.

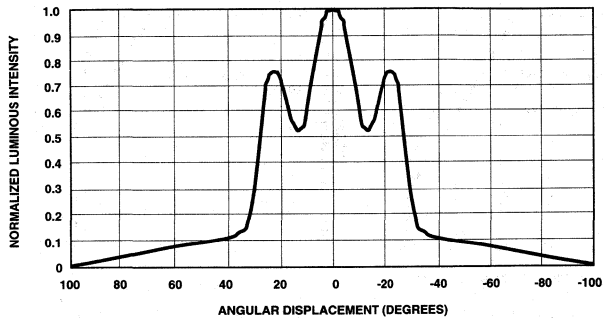

Figure 8a. Relative Intensity vs. Angle, HLMP-V100 Horizontal Axis.

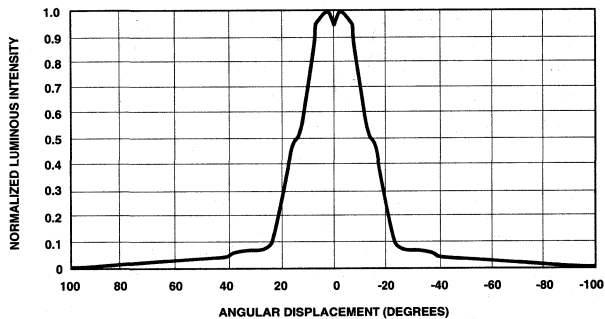

Figure 8b. Relative Intensity vs. Angle, HLMP-V100 Vertical Axis.

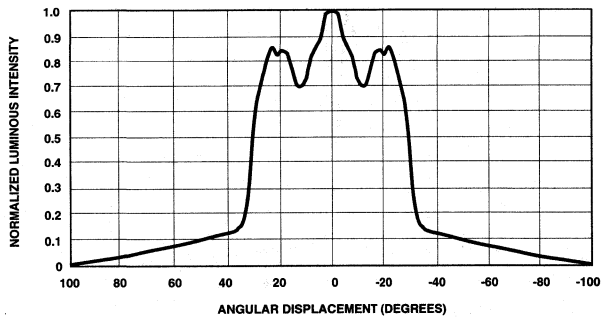

Figure 9a. Relative Intensity vs. Angle, HLMP-V500 Horizontal Axis.

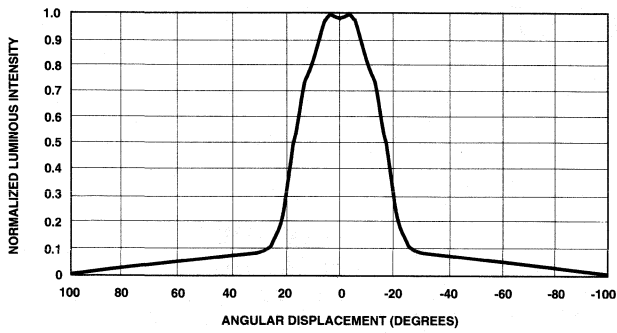

Figure 9b. Relative Intensity vs. Angle, HLMP-V500 Vertical Axis.

# T-1<sup>3/4</sup> (5 mm) SiC Blue LED Lamps

## Technical Data

### HLMP-DB00 HLMP-DB15

#### Features

- Silicon Carbide Technology
- 481 nm Blue Color
- Viewing Angles: Narrow and Wide
- CMOS/MOS Compatible

#### Applications

- Moving Message Signs
- Automotive Interior Lighting
- Front Panel Status Indicator
- Medical Instrumentation

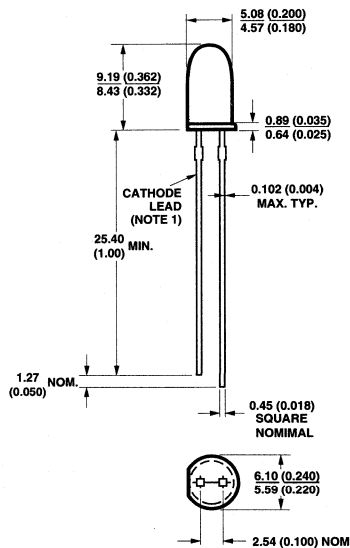
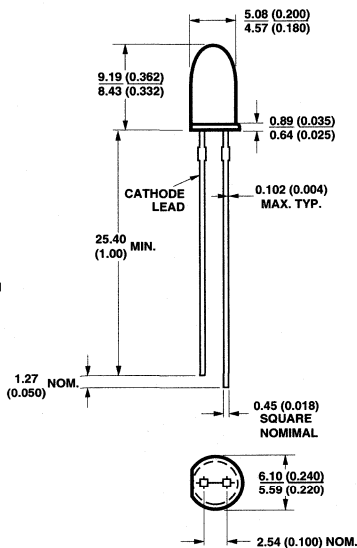
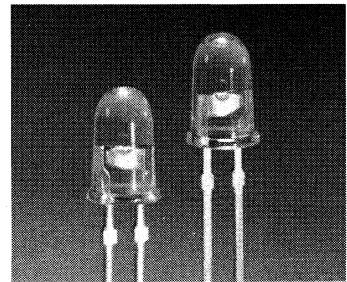

#### NOTES:

1. ALL DIMENSIONS ARE IN MILLIMETERS (INCHES).
2. THE LEADS ARE MILD STEEL, SOLDER DIPPED.
3. AN EPOXY MENISCUS MAY EXTEND ABOUT 1 mm (0.040") DOWN THE LEADS.

HLMP-DB15

HLMP-DB00

### Absolute Maximum Ratings at $T_A = 25^\circ\text{C}$

DC Forward Current <sup>[1]</sup> .....	50 mA
Peak Forward Current <sup>[2]</sup> .....	100 mA
Average Forward Current (@ $I_{\text{PEAK}} = 100 \text{ mA}$ , $f = 1 \text{ KHz}$ ) <sup>[2]</sup> .....	40 mA
LED Junction Temperature.....	110°C
Transient Forward Current (10 $\mu\text{s}$ Pulse) <sup>[3]</sup> .....	500 mA
Reverse Voltage ( $I_R = 100 \mu\text{A}$ ).....	5 V
Operating Temperature Range.....	-55 to 85°C
Storage Temperature Range.....	-55 to 100°C
Lead Soldering Temperature (1.59 mm [0.063 in.] from body).....	260°C for 5 seconds

#### Notes:

1. Derate linearly as shown in Figure 5.
2. Refer to Figure 6 to establish pulsed operating conditions.
3. The transient peak current is the maximum non-recurring peak current the device can withstand without damaging the LED die and wire bonds. Operating the device at peak currents above the absolute Maximum Peak Forward Current is not recommended.

### Optical Characteristics at $T_A = 25^\circ\text{C}$

Part Number HLMP-	Luminous Intensity $I_v$ (mcd) @ $I_F$ 20 mA <sup>[1]</sup>		Radiant Intensity $I_e$ ( $\mu\text{W}/\text{sr}$ ) @ 20 mA	Total Flux $\phi_v$ (mIm) @ 20 mA <sup>[2]</sup>	Color, Dominant Wavelength $\lambda_d$ <sup>[3]</sup> (nm)	Peak Wavelength $\lambda_{\text{PEAK}}$ (nm)	Viewing Angle $2\theta_{1/2}$ Degrees <sup>[4]</sup>
	Min.	Typ.	Typ.	Typ.	Typ.	Typ.	Typ.
DB00	1.0	3.0	23.1	2.0	480	470	38
DB15	6.3	12.0	93.3	2.0	480	470	15

#### Notes:

1. The luminous intensity,  $I_v$ , is measured at the peak of the spatial radiation pattern which may not be aligned with the geometric axis of the lamp package.
2.  $\phi_v$  is the total luminous flux output as measured with an integrating sphere.
3. The dominant wavelength,  $\lambda_d$ , is derived from the CIE Chromaticity Diagram and represents the color of the device.
4.  $\theta_{1/2}$  is the off-axis angle where the luminous intensity is 1/2 the peak intensity.

### Electrical Characteristics at $T_A = 25^\circ\text{C}$

Forward Voltage $V_F$ (Volts) @ $I_F$ 20 mA		Reverse Breakdown $V_R$ (Volts) @ $I_R = 100 \mu\text{A}$		Speed of Response $\tau_s$ (ns) Time Constant $e^{-t}/\tau_s$	Capacitance C (pF) $V_F = 0$ , $f = 1 \text{ MHz}$	Thermal Resistance $R\theta_{J-PIN}$ ( $^\circ\text{C}/\text{W}$ ) Junction to Cathode Lead
Typ.	Max.	Min.	Typ.	Typ.	Typ.	
3.5	4.0	5.0	45.0	500	97	260

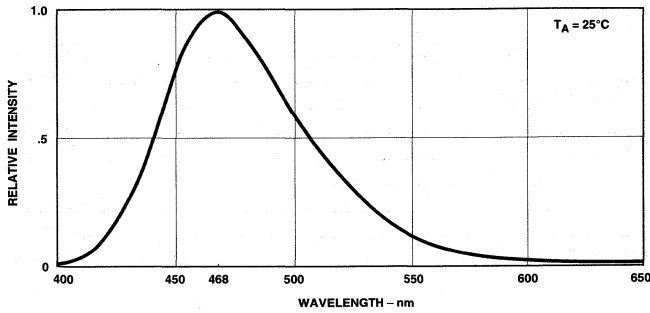

Figure 1. Relative Intensity vs. Wavelength.

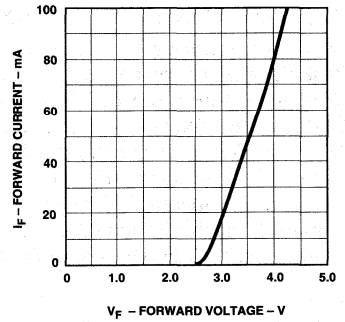

Figure 2. Forward Current vs. Forward Voltage.

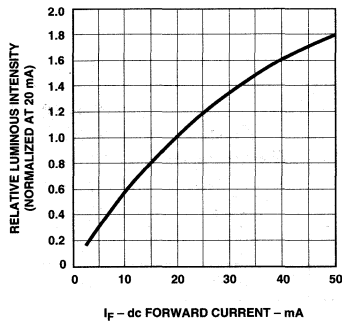

Figure 3. Relative Luminous Intensity vs. dc Forward Current.

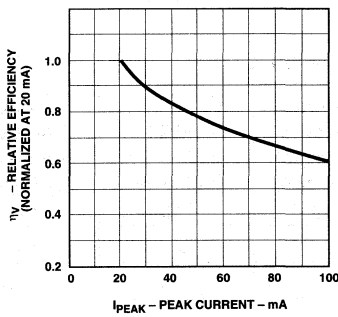

Figure 4. Relative Efficiency (Luminous Intensity per Unit Current) vs. Peak Current.

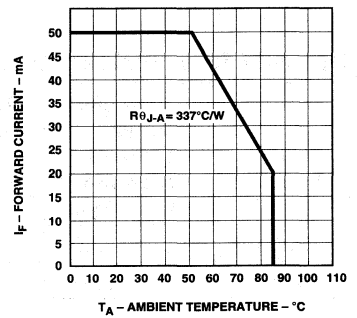

Figure 5. Maximum dc Current vs. Ambient Temperature. Derating Based on  $T_J$  Max. = 110°C.

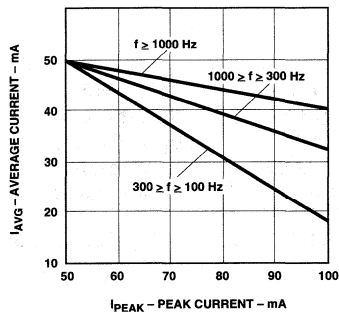

Figure 6. Time Average Current vs. Peak Forward Current as a Function of Pulsed Refresh Rate,  $f$  (Hz).

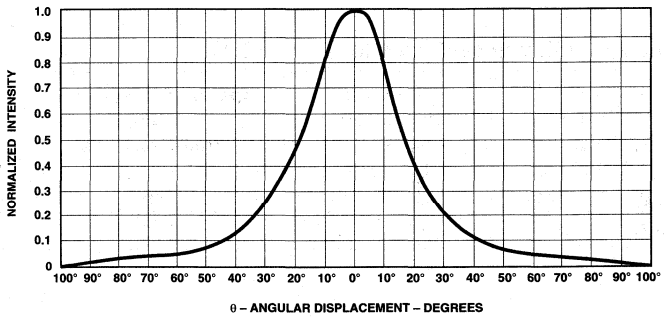

Figure 7. Normalized Luminous Intensity vs. Angular Displacement, HLMP-DB00.

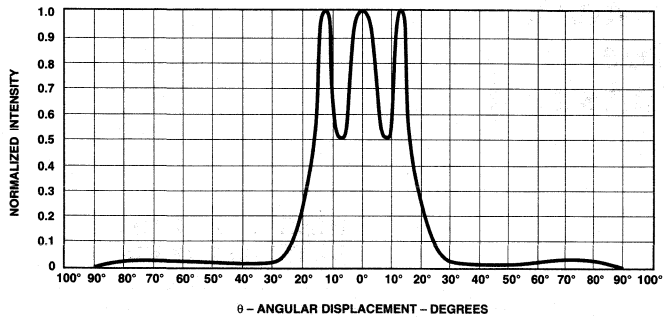

Figure 8. Normalized Luminous Intensity vs. Angular Displacement HLMP-DB15.

# T-1<sup>3/4</sup> (5 mm), T-1 (3 mm), High Intensity, Double Heterojunction AlGaAs Red LED Lamps

## Technical Data

**HLMP-D101/D105**  
**HLMP-K101/K105**

### Features

- Exceptional Brightness
- Wide Viewing Angle
- Outstanding Material Efficiency
- Low Forward Voltage
- CMOS/MOS Compatible
- TTL Compatible
- Deep Red Color

### Applications

- Bright Ambient Lighting Conditions
- Moving Message Panels

- Portable Equipment
- General Use

### Description

These solid state LED lamps utilize newly developed double heterojunction (DH) AlGaAs/GaAs material technology. This LED material has outstanding light output efficiency over a wide range of drive currents. The color is deep red at the dominant wavelength of 637 nanometres. These lamps may be DC or pulse driven to achieve desired light output.

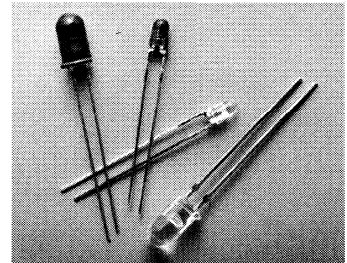

### Package Dimensions

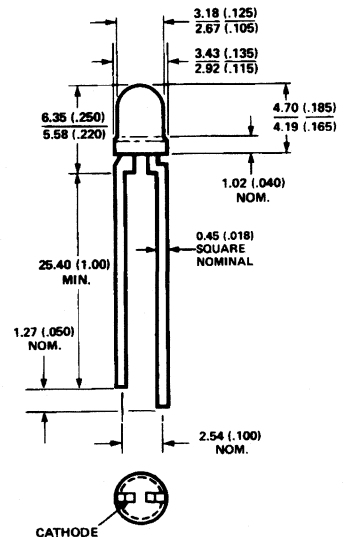
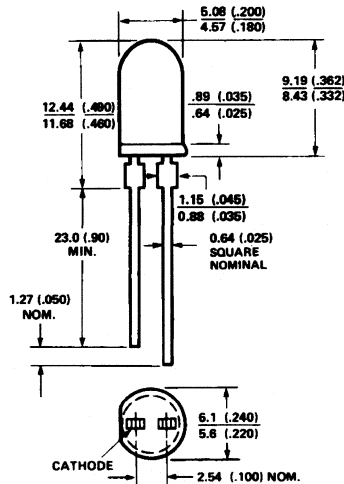
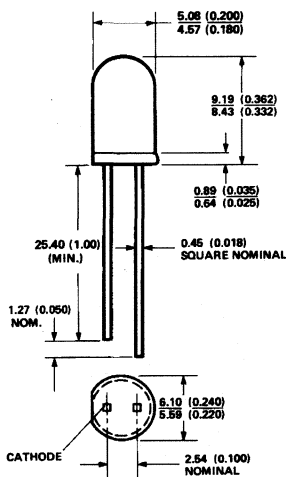

NOTES:  
1. ALL DIMENSIONS ARE IN MILLIMETRES (INCHES).  
2. AN EPOXY MINISCUS MAY EXTEND ABOUT 1 mm (0.040") DOWN THE LEADS.



### Axial Luminous Intensity and Viewing Angle @ 25°C

Part Number HLMP-	Package Description	I <sub>v</sub> (mcd) @ 20 mA		2θ <sub>1/2</sub> <sup>[1]</sup> Degrees	Package Outline
		Min.	Typ.		
D101	T-1 3/4 Red Tinted Diffused	35	70	65	A
D105	T-1 3/4 Red Untinted, Non-diffused	90	240	24	B
K101	T-1 Red Tinted Diffused	22	45	60	C
K105	T-1 Red Untinted Non-diffused	35	65	45	C

**Note:**

1. θ<sub>1/2</sub> is the off axis angle from lamp centerline where the luminous intensity is 1/2 the on-axis value.

### Absolute Maximum Ratings at T<sub>A</sub> = 25°C

Peak Forward Current <sup>[1,2]</sup> .....	300 mA
Average Forward Current <sup>[2]</sup> .....	20 mA
DC Current <sup>[3]</sup> .....	30 mA
Power Dissipation .....	87 mW
Reverse Voltage (I <sub>R</sub> = 100 µA) .....	5 V
Transient Forward Current (10 µs Pulse) <sup>[4]</sup> .....	500 mA
LED Junction Temperature .....	110°C
Operating Temperature Range .....	-20 to +100°C
Storage Temperature Range .....	-55 to +100°C
Lead Soldering Temperature [1.6 mm (0.063 in.) from body] .....	260°C for 5 seconds

**Notes:**

1. Maximum I<sub>PEAK</sub> at f = 1 kHz, DF = 6.7%.
2. Refer to Figure 6 to establish pulsed operating conditions.
3. Derate linearly as shown in Figure 5.
4. The transient peak current is the maximum non-recurring peak current the device can withstand without damaging the LED die and wire bonds. It is not recommended that the device be operated at peak currents beyond the Absolute Maximum Peak Forward Current.

## Electrical/Optical Characteristics at $T_A = 25^\circ\text{C}$

Symbol	Description	Min.	Typ.	Max.	Unit	Test Condition
$V_F$	Forward Voltage		1.8	2.2	V	$I_F = 20\text{ mA}$
$V_R$	Reverse Breakdown Voltage	5.0	15.0		V	$I_R = 100\ \mu\text{A}$
$\lambda_p$	Peak Wavelength		645		nm	Measurement at Peak
$\lambda_d$	Dominant Wavelength		637		nm	Note 1
$\Delta\lambda_{1/2}$	Spectral Line Halfwidth		20		nm	
$\tau_s$	Speed of Response		30		ns	Exponential Time Constant, $e^{-t}/T_s$
C	Capacitance		30		pF	$V_F = 0, f = 1\text{ MHz}$
$R\theta_{J-PIN}$	Thermal Resistance		260 <sup>[3]</sup> 210 <sup>[4]</sup> 290 <sup>[5]</sup>		$^\circ\text{C/W}$	Junction to Cathode Lead
$\eta_V$	Luminous Efficacy		80		lm/W	Note 2

### Notes:

1. The dominant wavelength,  $\lambda_d$ , is derived from the CIE chromaticity diagram and represents the color of the device.
2. The radiant intensity,  $I_e$ , in watts per steradian, may be found from the equation  $I_e = I_v/\eta_V$ , where  $I_v$  is the luminous intensity in candelas and  $\eta_V$  is luminous efficacy in lumens/watt.
3. HLMP-D101.
4. HLMP-D105.
5. HLMP-K101/K105.

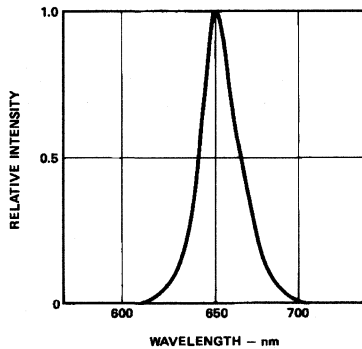

Figure 1. Relative Intensity vs. Wavelength.

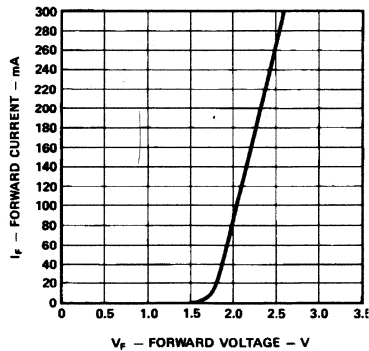

Figure 2. Forward Current vs. Forward Voltage.

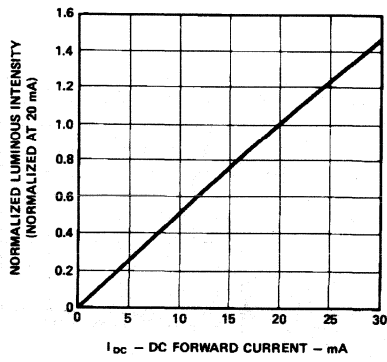

Figure 3. Relative Luminous Intensity vs. DC Forward Current.

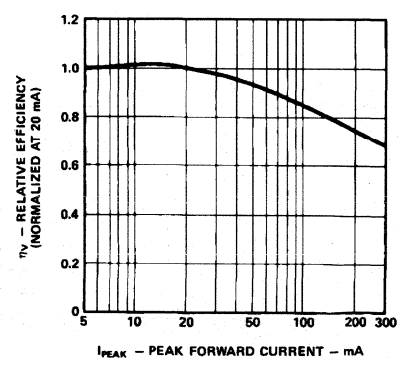

Figure 4. Relative Efficiency vs. Peak Forward Current.

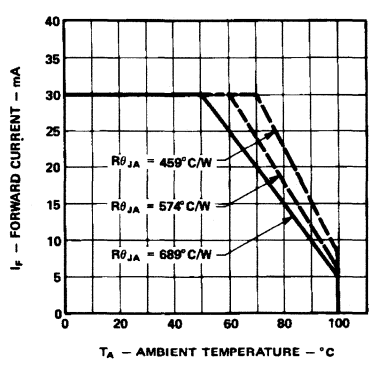

Figure 5. Maximum Forward DC Current vs. Ambient Temperature. Derating Based on T<sub>J</sub> MAX = 110°C.

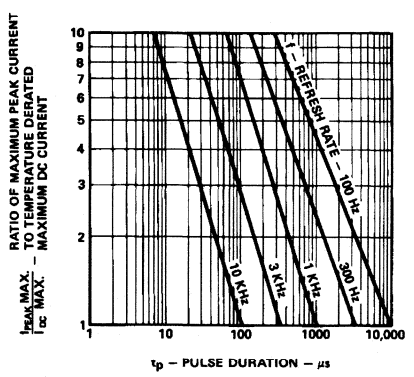

Figure 6. Maximum Tolerable Peak Current vs. Peak Duration (I<sub>PEAK</sub> MAX Determined from Temperature Derated I<sub>DC</sub> MAX).

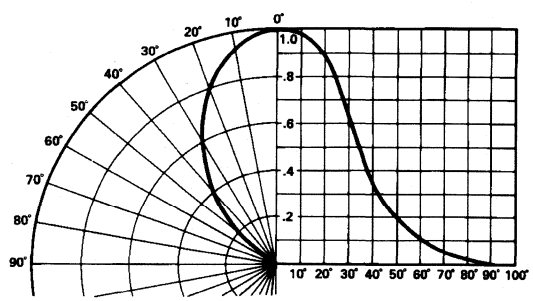

Figure 7. Relative Luminous Intensity vs. Angular Displacement. HLMP-D101.

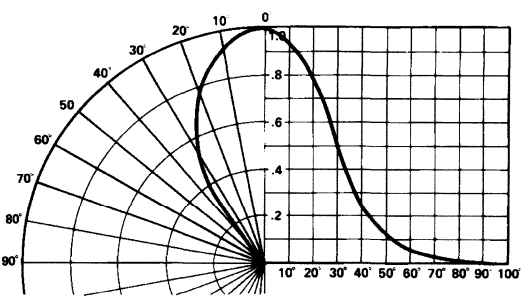
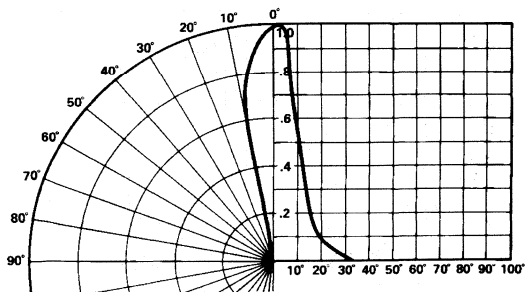
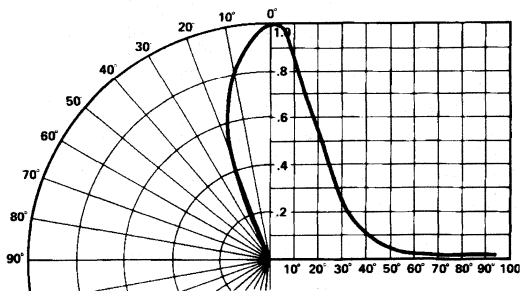

Figure 8. Relative Luminous Intensity vs. Angular Displacement. HLMP-K101.



**Figure 9. Relative Luminous Intensity vs. Angular Displacement. HLMF-D105.**



**Figure 10. Relative Luminous Intensity vs. Angular Displacement. HLMF-K105.**

# T-1<sup>3/4</sup> (5 mm), T-1 (3 mm), Low Current, Double Heterojunction AlGaAs Red LED Lamps

## Technical Data

### Features

- Minimum Luminous Intensity Specified at 1 mA
- High Light Output at Low Currents
- Wide Viewing Angle
- Outstanding Material Efficiency
- Low Power/Low Forward Voltage
- CMOS/MOS Compatible
- TTL Compatible
- Deep Red Color

### Applications

- Low Power Circuits
- Battery Powered Equipment
- Telecommunication Indicators

### Description

These solid state LED lamps utilize newly developed double heterojunction (DH) AlGaAs/GaAs material technology. This LED material has outstanding light output efficiency at very low drive currents. The color is deep red at the dominant wavelength of 637 nanometres. These lamps are

**HLMP-D150/D155**  
**HLMP-K150/K155**

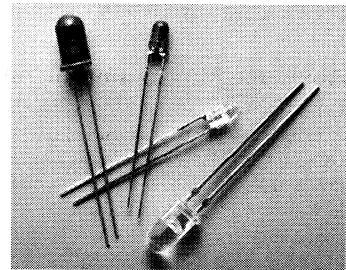

ideally suited for use in applications where high light output is required with minimum power output.

### Package Dimensions

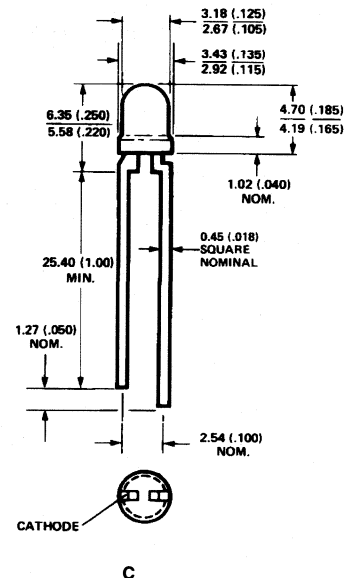
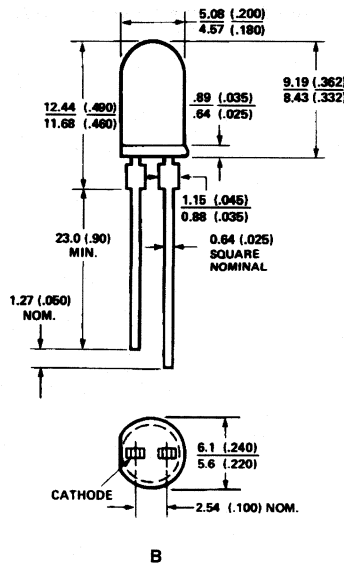
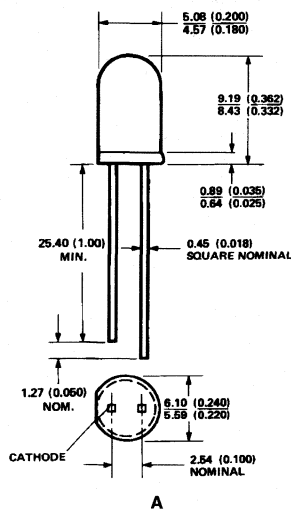

NOTES:  
1. ALL DIMENSIONS ARE IN MILLIMETRES (INCHES).  
2. AN EPOXY MINISCUS MAY EXTEND ABOUT 1 mm (0.040") DOWN THE LEADS.

## Axial Luminous Intensity and Viewing Angle @ 25°C

Part Number HLMP-	Package Description	I <sub>v</sub> (mcd) @ 1 mA DC		2θ <sup>1/2</sup> [1] Degrees	Package Outline
		Min.	Typ.		
D150	T-1 <sup>3/4</sup> Red Tinted Diffused	1.3	3	65	A
D155	T-1 <sup>3/4</sup> Red Untinted, Non-diffused	5.4	10	24	B
K150	T-1 Red Tinted Diffused	1.3	2	60	C
K155	T-1 Red Untinted Non-diffused	2.1	3	45	C

**Note:**

1. θ<sup>1/2</sup> is the off axis angle from lamp centerline where the luminous intensity is 1/2 the on-axis value.

## Absolute Maximum Ratings at T<sub>A</sub> = 25°C

Peak Forward Current <sup>[1]</sup> .....	300 mA
Average Forward Current .....	20 mA
DC Current <sup>[2]</sup> .....	30 mA
Power Dissipation .....	87 mW
Reverse Voltage (I <sub>R</sub> = 100 μA) .....	5 V
Transient Forward Current (10 μs Pulse) <sup>[3]</sup> .....	500 mA
LED Junction Temperature .....	110°C
Operating Temperature Range .....	-20 to +100°C
Storage Temperature Range .....	-55 to +100°C
Lead Soldering Temperature [1.6 mm (0.063 in.) from body] .....	260°C for 5 seconds

**Notes:**

1. Maximum I<sub>PEAK</sub> at f = 1 kHz, DF = 6.7%.
2. Derate linearly as shown in Figure 4.
3. The transient peak current is the maximum non-recurring peak current the device can withstand without damaging the LED die and wire bonds. It is not recommended that the device be operated at peak currents beyond the Absolute Maximum Peak Forward Current.

### Electrical/Optical Characteristics at $T_A = 25^\circ\text{C}$

Symbol	Description	Min.	Typ.	Max.	Unit	Test Condition
$V_F$	Forward Voltage		1.6	1.8	V	$I_F = 1 \text{ mA}$
$V_R$	Reverse Breakdown Voltage	5.0	15.0		V	$I_R = 100 \mu\text{A}$
$\lambda_p$	Peak Wavelength		645		nm	Measurement at Peak
$\lambda_d$	Dominant Wavelength		637		nm	Note 1
$\Delta\lambda^{1/2}$	Spectral Line Halfwidth		20		nm	
$\tau_s$	Speed of Response		30		ns	Exponential Time Constant, $e^{-1}/T_s$
C	Capacitance		30		pF	$V_F = 0, f = 1 \text{ MHz}$
$R\theta_{J-PIN}$	Thermal Resistance		260 <sup>[3]</sup> 210 <sup>[4]</sup> 290 <sup>[5]</sup>		$^\circ\text{C/W}$	Junction to Cathode Lead
$\eta_V$	Luminous Efficacy		80		$\text{lm/W}$	Note 2

**Notes:**

1. The dominant wavelength,  $\lambda_d$ , is derived from the CIE chromaticity diagram and represents the color of the device.
2. The radiant intensity,  $I_e$ , in watts per steradian, may be found from the equation  $I_e = I_v/\eta_V$ , where  $I_v$  is the luminous intensity in candelas and  $\eta_V$  is luminous efficacy in lumens/watt.
3. HLMP-D150.
4. HLMP-D155.
5. HLMP-K150/-K155.

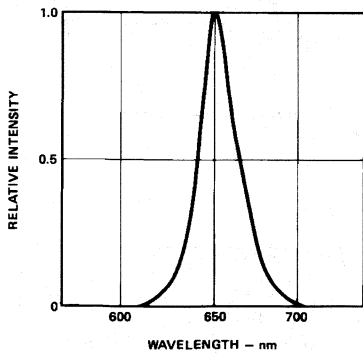

Figure 1. Relative Intensity vs. Wavelength.

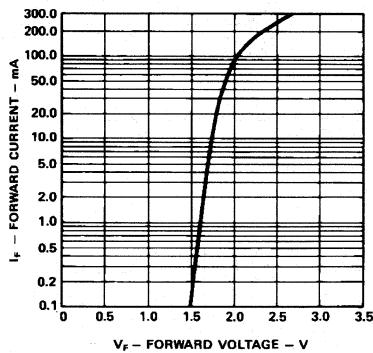

Figure 2. Forward Current vs. Forward Voltage.

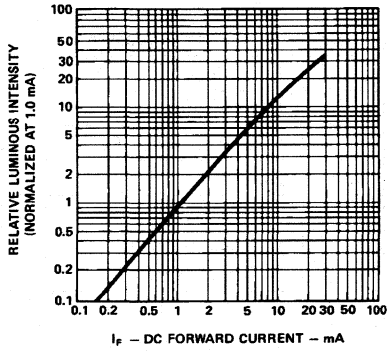

Figure 3. Relative Luminous Intensity vs. DC Forward Current.

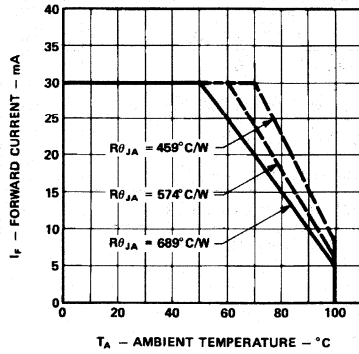

Figure 4. Maximum Forward DC Current vs. Ambient Temperature. Derating Based on  $T_J$  Max. = 110 °C.

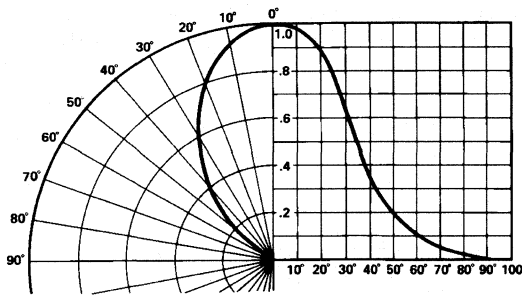

Figure 5. Relative Luminous Intensity vs. Angular Displacement. HLMP-D150.

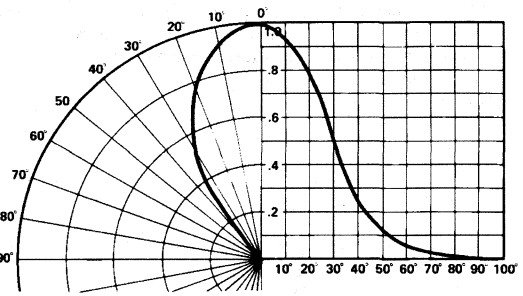

Figure 6. Relative Luminous Intensity vs. Angular Displacement. HLMP-K150.

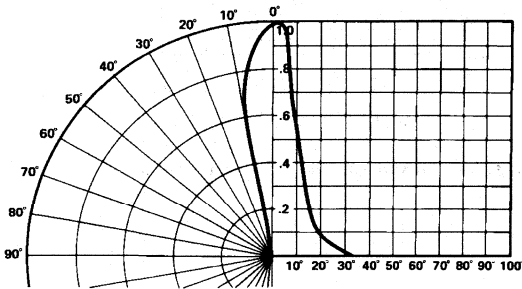

Figure 7. Relative Luminous Intensity vs. Angular Displacement. HLMP-D155.

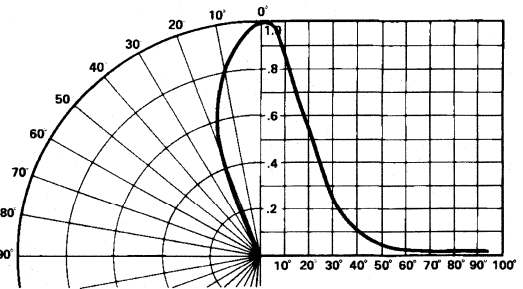

Figure 8. Relative Luminous Intensity vs. Angular Displacement. HLMP-K155.



# T-1<sup>3/4</sup> Super Ultra-Bright LED Lamps

## Technical Data

**HLMP-8115**    **HLMP-8109**  
**HLMP-8205**    **HLMP-8209**  
**HLMP-8305**    **HLMP-8309**  
**HLMP-8405**    **HLMP-8409**  
**HLMP-8505**    **HLMP-8509**  
**HLMP-8605**

### Features

- **Very High Intensity**
- **Narrow and Medium Viewing Angles**
- **Untinted, Nondiffused Lens**
- **Choice of Five Colors**
- **Sturdy Leads with Seating Plane Tabs**

### Description

These untinted, nondiffused solid state lamps are designed with special internal optics to give a very high luminous intensity within a well defined viewing angle. The LED materials used within these devices is specifically grown to assure the high light output performance these lamps provide.

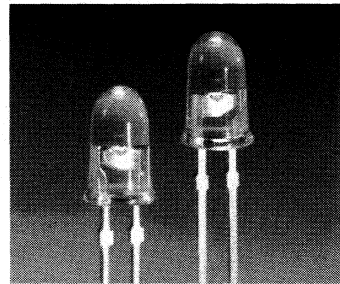

### Device Selection Guide

LED Color	Part Number	Typical Luminous Intensity (mcd @ 20 mA dc)	20 <sup>1/2</sup> Viewing Angle
DH AS AlGaAs	HLMP-8115	1000	10°
	HLMP-8109	500	20°
High Efficiency Red	HLMP-8205	350	10°
	HLMP-8209	260	20°
Yellow	HLMP-8305	350	10°
	HLMP-8309	260	20°
Orange	HLMP-8405	350	10°
	HLMP-8409	260	20°
High Performance Green	HLMP-8505	400	10°
	HLMP-8509	300	20°
Emerald Green	HLMP-8605	75	10°

## Package Dimensions

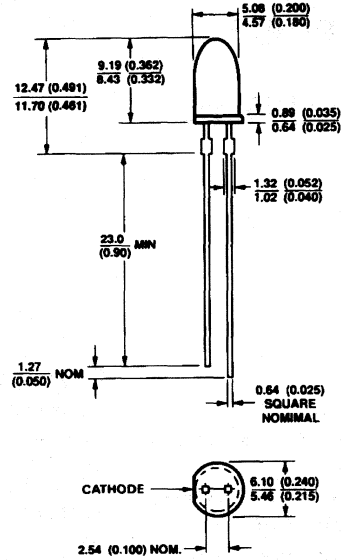
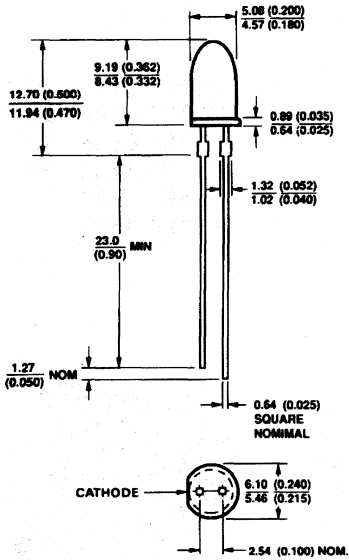

- NOTES:
1. ALL DIMENSIONS ARE IN MILLIMETRES (INCHES).
  2. THE LEADS ARE MILD STEEL, SOLDER DIPPED.
  3. AN EPOXY MENISCUS MAY EXTEND ABOUT 1 mm (0.040") DOWN THE LEADS.

## Absolute Maximum Ratings at $T_A = 25^\circ\text{C}$

Parameter	DH AS AlGaAs Red	High Efficiency Red and Orange	Yellow	High Performance Green/Emerald Green	Units
DC Forward Current <sup>[1]</sup>	30	30	20	30	mA
Peak Forward Current <sup>[2]</sup>	300	90	60	90	mA
Average Forward Current <sup>[2]</sup>	20	25	20	25	mA
Transient Forward Current <sup>[3]</sup> (10 $\mu\text{s}$ Pulse)	500	500	500	500	mA
Reverse Voltage ( $I_R = 100 \mu\text{A}$ )	5	5	5	5	V
LED Junction Temperature	110	110	110	110	$^\circ\text{C}$
Operating Temperature Range	-20 to +100	-55 to +100		-20 to +100	$^\circ\text{C}$
Storage Temperature Range	-55 to +100				$^\circ\text{C}$
Lead Soldering Temperature [1.6 mm (0.063 in.) from body]	260 $^\circ\text{C}$ for 5 seconds				

### Notes:

1. See Figure 5 for maximum current derating vs. ambient temperature.
2. See Figure 6 for maximum peak current vs. pulse duration and allowable duty factor.
3. The transient peak current is the maximum non-recurring peak current the device can withstand without damaging the LED die and wire bond. Do not operate these lamps at peak currents above the Absolute Maximum Peak Forward Current.

## Electrical/Optical Characteristics $T_A = 25^\circ\text{C}$

### DH AS AlGaAs HLMP-8115/8109

Parameter	Symbol	Min.	Typ.	Max.	Units	Test Conditions
Luminous Intensity HLMP-8115 HLMP-8109	$I_v$	500 200	1000 500		mcd	$I_F = 20 \text{ mA}$
Forward Voltage	$V_F$		1.8	2.2	V	$I_F = 20 \text{ mA}$
Reverse Breakdown Voltage	$V_R$	5.0	15.0		V	$I_R = 100 \mu\text{A}$
Included Angle Between Half Intensity Points HLMP-8115 HLMP-8109	$2\theta_{1/2}$		10 20		Deg.	
Total Luminous Flux	$\phi_d$		120		mlm	$I_F = 20 \text{ mA}$
Peak Wavelength	$\lambda_{\text{PEAK}}$		645		nm	Measured at Peak
Dominant Wavelength <sup>(1)</sup>	$\lambda_d$		637		nm	
Spectral Line Half Width	$\Delta\lambda_{1/2}$		20		nm	
Speed of Response	$\tau_s$		30		ns	Time Constant, $e^{-t/\tau_s}$
Capacitance	C		30		pF	$V_F = 0, f = 1 \text{ MHz}$
Thermal Resistance	$R\theta_{\text{J-LEAD}}$		210		$^\circ\text{C/W}$	LED Junction-to-Cathode Lead
Luminous Efficacy <sup>(2)</sup>	$\eta_v$		80		lm/W	

### High Efficiency Red HLMP-8205/8209

Parameter	Symbol	Min.	Typ.	Max.	Units	Test Conditions
Luminous Intensity HLMP-8205 HLMP-8209	$I_v$	200 90	350 260		mcd	$I_F = 20 \text{ mA}$
Forward Voltage	$V_F$		1.9	2.6	V	$I_F = 20 \text{ mA}$
Reverse Breakdown Voltage	$V_R$	5.0	30.0		V	$I_R = 100 \mu\text{A}$
Included Angle Between Half Intensity Points HLMP-8205 HLMP-8209	$2\theta_{1/2}$		10 20		Deg.	
Total Luminous Flux	$\phi_v$		45		mlm	$I_F = 20 \text{ mA}$
Peak Wavelength	$\lambda_{\text{PEAK}}$		635		nm	Measured at Peak
Dominant Wavelength <sup>(1)</sup>	$\lambda_d$		626		nm	
Spectral Line Half Width	$\Delta\lambda_{1/2}$		40		nm	
Speed of Response	$\tau_s$		90		ns	
Capacitance	C		11		pF	$V_F = 0, f = 1 \text{ MHz}$
Thermal Resistance	$R\theta_{\text{J-LEAD}}$		210		$^\circ\text{C/W}$	LED Junction-to-Cathode Lead
Luminous Efficacy <sup>(2)</sup>	$\eta_v$		145		lm/W	

**Yellow HLMP-8305/8309**

Parameter	Symbol	Min.	Typ.	Max.	Units	Test Conditions
Luminous Intensity HLMP-8305 HLMP-8309	$I_v$	212 96	350 260		mcd	$I_F = 20 \text{ mA}$
Forward Voltage	$V_F$		2.1	2.6	V	$I_F = 20 \text{ mA}$
Reverse Breakdown Voltage	$V_R$	5.0	30.0		V	$I_R = 100 \mu\text{A}$
Included Angle Between Half Intensity Points HLMP-8305 HLMP-8309	$2\theta_{1/2}$		10 20		Deg.	
Total Luminous Flux	$\phi_v$		45		mlm	$I_F = 20 \text{ mA}$
Peak Wavelength	$\lambda_{\text{PEAK}}$		583		nm	Measured at Peak
Dominant Wavelength <sup>[1]</sup>	$\lambda_d$		585		nm	
Spectral Line Half Width	$\Delta\lambda_{1/2}$		36		nm	
Speed of Response	$\tau_s$		90		ns	
Capacitance	C		15		pF	$V_F = 0, f = 1 \text{ MHz}$
Thermal Resistance	$R\theta_{\text{J-LEAD}}$		210		°C/W	LED Junction-to-Cathode Lead
Luminous Efficacy <sup>[2]</sup>	$\eta_v$		500		lm/W	

**Orange HLMP-8405/8409**

Parameter	Symbol	Min.	Typ.	Max.	Units	Test Conditions
Luminous Intensity HLMP-8405 HLMP-8409	$I_v$	200 90	350 260		mcd	$I_F = 20 \text{ mA}$
Forward Voltage	$V_F$		1.9	2.6	V	$I_F = 20 \text{ mA}$
Reverse Breakdown Voltage	$V_R$	5.0	30.0		V	$I_R = 100 \mu\text{A}$
Included Angle Between Half Intensity Points HLMP-8405 HLMP-8409	$2\theta_{1/2}$		10 20		Deg.	
Total Luminous Flux	$\phi_v$		45		mlm	$I_F = 20 \text{ mA}$
Peak Wavelength	$\lambda_{\text{PEAK}}$		600		nm	Measured at Peak
Dominant Wavelength <sup>[1]</sup>	$\lambda_d$		602		nm	
Spectral Line Half Width	$\Delta\lambda_{1/2}$		40		nm	
Speed of Response	$\tau_s$		280		ns	
Capacitance	C		4		pF	$V_F = 0, f = 1 \text{ MHz}$
Thermal Resistance	$R\theta_{\text{J-LEAD}}$		210		°C/W	LED Junction-to-Cathode Lead
Luminous Efficacy <sup>[2]</sup>	$\eta_v$		380		lm/W	

**High Performance Green HLMP-8505/8509**

Parameter	Symbol	Min.	Typ.	Max.	Units	Test Conditions
Luminous Intensity HLMP-8505 HLMP-8509	$I_v$	170 111	400 300		mcd	$I_F = 20 \text{ mA}$
Forward Voltage	$V_F$		2.2	3.0	V	$I_F = 20 \text{ mA}$
Reverse Breakdown Voltage	$V_R$	5.0	30		V	$I_R = 100 \mu\text{A}$
Included Angle Between Half Intensity Points HLMP-8505 HLMP-8509	$2\theta_{1/2}$		10 20		Deg.	
Total Luminous Flux	$\phi_v$		115		mlm	$I_F = 20 \text{ mA}$
Peak Wavelength	$\lambda_{\text{PEAK}}$		568		nm	Measured at Peak
Dominant Wavelength <sup>[1]</sup>	$\lambda_d$		570		nm	
Spectral Line Half Width	$\Delta\lambda_{1/2}$		28		nm	
Speed of Response	$\tau_s$		260		ns	
Capacitance	C		18		pF	$V_F = 0, f = 1 \text{ MHz}$
Thermal Resistance	$R\theta_{\text{J-LEAD}}$		210		°C/W	LED Junction-to-Cathode Lead
Luminous Efficacy <sup>[2]</sup>	$\eta_v$		595		lm/W	

**Notes:**

1. The dominant wavelength,  $\lambda_d$ , is derived from the CIE Chromaticity Diagram and represents the color of the device.
2. The radiant intensity,  $I_e$ , in watts per steradian, may be found from the equation  $I_e = I_v/\eta_v$ , where  $I_v$  is the luminous intensity in candelas and  $\eta_v$  is the luminous efficacy in lumens/watt.

**Emerald Green HLMP-8605<sup>[1]</sup>**

Parameter	Symbol	Min.	Typ.	Max.	Units	Test Conditions
Luminous Intensity HLMP-8605	$I_v$	69	75		mcd	$I_F = 20 \text{ mA}$
Forward Voltage	$V_F$		2.2	3.0	V	$I_F = 20 \text{ mA}$
Reverse Breakdown Voltage	$V_R$	5.0	30		V	$I_R = 100 \mu\text{A}$
Included Angle Between Half Intensity Points HLMP-8605	$2\theta_{1/2}$		10		Deg.	
Peak Wavelength	$\lambda_{\text{PEAK}}$		558		nm	Measured at Peak
Dominant Wavelength <sup>[2]</sup>	$\lambda_d$		560		nm	
Spectral Line Half Width	$\Delta\lambda_{1/2}$		24		nm	
Speed of Response	$\tau_s$		3100		ns	
Capacitance	C		35		pF	$V_F = 0, f = 1 \text{ MHz}$
Thermal Resistance	$R\theta_{\text{J-LEAD}}$		210		°C/W	LED Junction-to-Cathode Lead
Luminous Efficacy <sup>[3]</sup>	$\eta_v$		656		lm/W	

**Notes:**

1. Please refer to Application Note 1061 for information comparing standard green and emerald green light output degradation.
2. The dominant wavelength,  $\lambda_d$ , is derived from the CIE Chromaticity Diagram and represents the color of the device.
3. The radiant intensity,  $I_e$ , in watts per steradian, may be found from the equation  $I_e = I_v/\eta_v$ , where  $I_v$  is the luminous intensity in candelas and  $\eta_v$  is the luminous efficacy in lumens/watt.

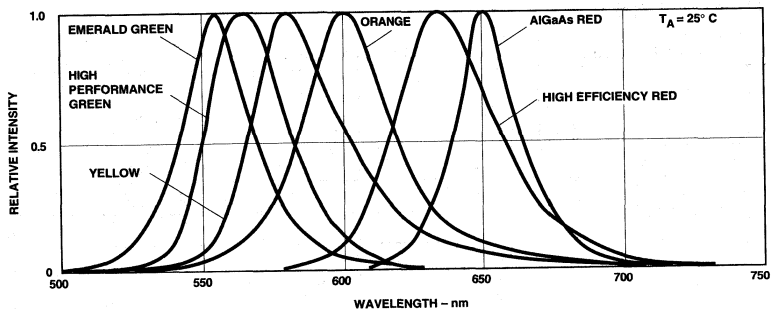

Figure 1. Relative Intensity vs. Wavelength.

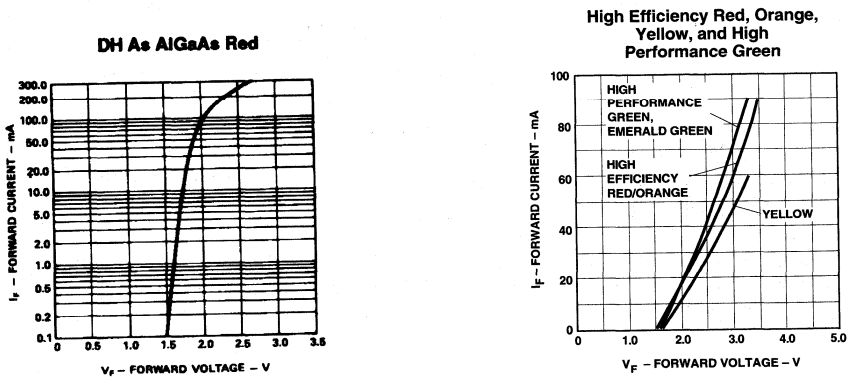

Figure 2. Forward Current vs. Forward Voltage (Non-Resistor Lamp).

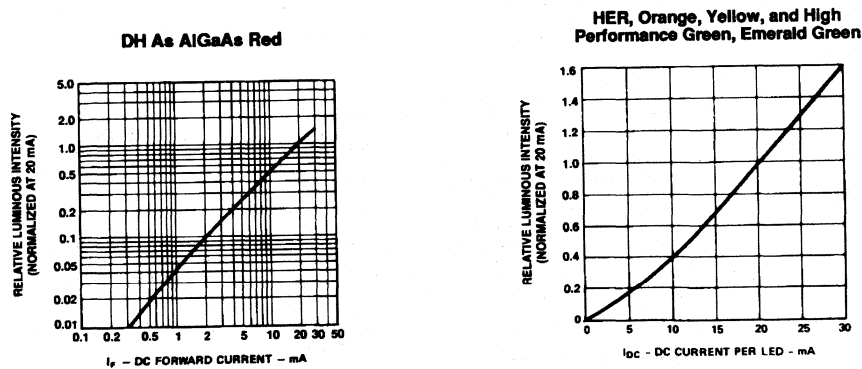

Figure 3. Relative Luminous Intensity vs. Forward Current.

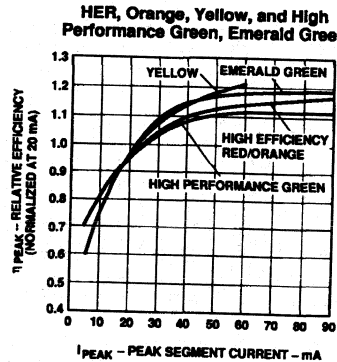
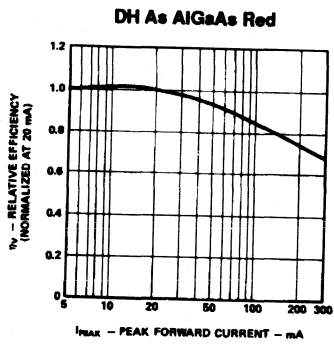

Figure 4. Relative Efficiency (Luminous Intensity per Unit Current) vs. Peak Current.

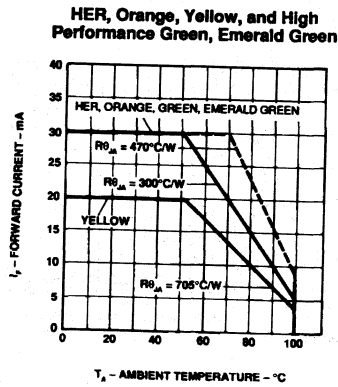
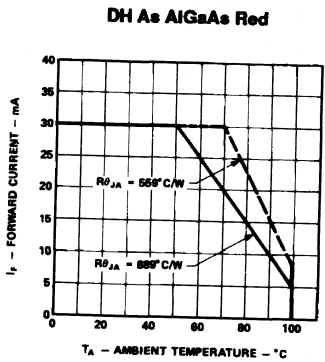

Figure 5. Maximum Forward dc Current vs. Ambient Temperature. Derating Based on  $T_j, \text{MAX} = 110^\circ\text{C}$ .

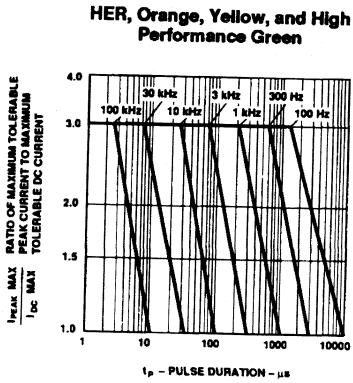
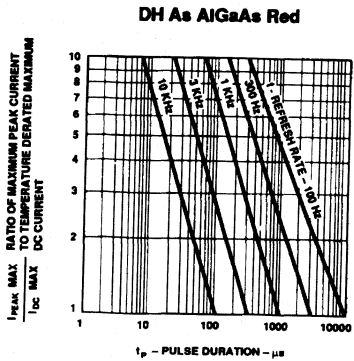

Figure 6. Maximum Tolerable Peak Current vs. Pulse Duration. ( $I_{DC, \text{MAX}}$  as per MAX Ratings).

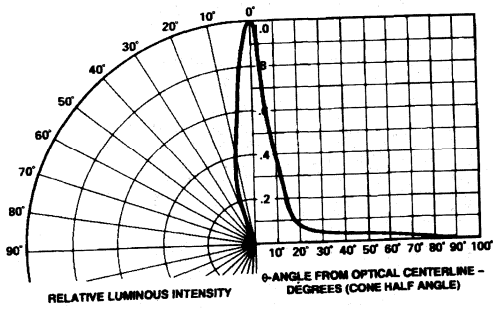

Figure 7. Relative Luminous Intensity vs. Angular Displacement. HLMP-8115/-8X05.

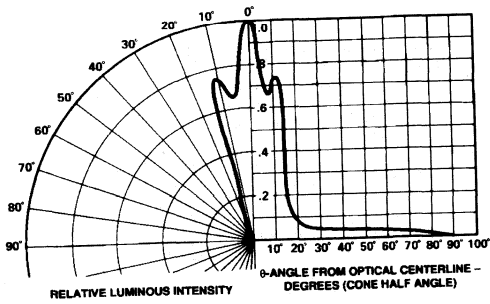

Figure 8. Relative Luminous Intensity vs. Angular Displacement. HLMP-8X09.



# T-1<sup>3/4</sup> (5 mm), T-1 (3 mm), Ultra-Bright LED Lamps

## Technical Data

**HLMP-3750, -3850, -3950  
HLMP-3390, -3490, -3590  
HLMP-1340, -1440, -1540  
HLMP-D640  
HLMP-K640**

### Features

- Improved Brightness
- Improved Color Performance
- Available in Popular T-1 and T-1<sup>3/4</sup> Packages
- New Sturdy Leads
- IC Compatible/Low Current Capability
- Reliable and Rugged
- Choice of 3 Bright Colors  
High Efficiency Red  
High Brightness Yellow  
High Performance Green

### Applications

- Lighted Switches
- Backlighting Front Panels
- Light Pipe Sources
- Keyboard Indicators

### Description

These clear, non-diffused lamps out-perform conventional LED lamps. By utilizing new higher intensity material, we achieve superior product performance.

The HLMP-3750/-3390/-1340 Series Lamps are Gallium Arsenide Phosphide on Gallium Phosphide red light emitting diodes. The HLMP-3850/

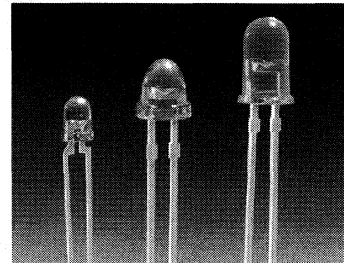

-3490/-1440 Series are Gallium Arsenide Phosphide on Gallium Phosphide yellow light emitting diodes. The HLMP-3950/-3590/-1540/-D640/-K640 Series Lamps are Gallium Phosphide green light emitting diodes.

### Axial Luminous Intensity and Viewing Angle @ 25°C

Part Number HLMP-	Package Description	Color	I <sub>v</sub> (mcd) @ 20 mA DC		2θ <sup>1/2</sup> [1]	Package Outline
			Min.	Typ.		
3750	T-1 <sup>3/4</sup>	HER	90	125	24°	A
3850		Yellow	96	140	24°	A
3950		Green	111	140	24°	A
D640 <sup>[2]</sup>		Emerald Green	6.7	21	24°	D
3390	T-1 <sup>3/4</sup> Low Profile	HER	35	55	32°	B
3490		Yellow	37	55	32°	B
3590		Green	40	55	32°	B
1340	T-1	HER	22	45	45°	C
1440		Yellow	23	45	45°	C
1540		Green	27	45	45°	C
K640 <sup>[2]</sup>		Emerald Green	4.2	21	45°	C

**Note:**

1. θ<sup>1/2</sup> is the typical off-axis angle at which the luminous intensity is half the axial luminous intensity.
2. Please refer to Application Note 1061 for information comparing standard green and emerald green light output degradation.

## Package Dimensions

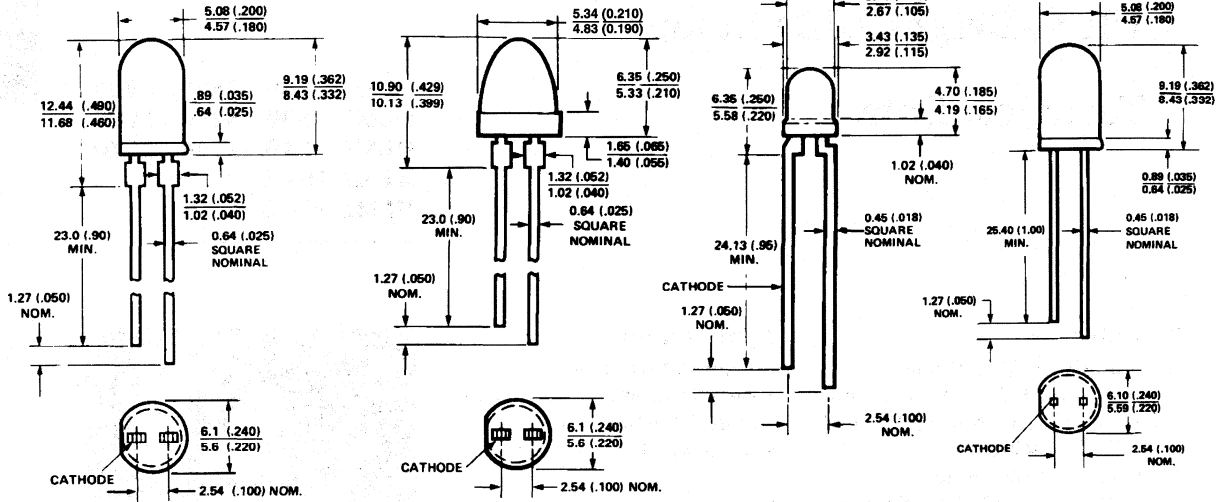

**PACKAGE OUTLINE "A"**  
HLMP-3750, -3850, -3950

**PACKAGE OUTLINE "B"**  
HLMP-3390, -3490, -3590

**PACKAGE OUTLINE "C"**  
HLMP-1340, -1440, -1540, -K640

NOTES:  
1. ALL DIMENSIONS ARE IN MILLIMETERS (INCHES).  
2. AN EPOXY MENISCUS MAY EXTEND ABOUT 1 mm (0.40") DOWN THE LEADS.

## Absolute Maximum Ratings at $T_A = 25^\circ\text{C}$

Parameter	Red	Yellow	Green/Emerald Green	Units
Peak Forward Current	90	60	90	mA
Average Forward Current <sup>[1]</sup>	25	20	25	mA
DC Current <sup>[2]</sup>	30	20	30	mA
Transient Forward Current <sup>[3]</sup> (10 $\mu\text{s}$ Pulse)	500	500	500	mA
Reverse Voltage ( $I_R = 100 \mu\text{A}$ )	5	5	5	V
LED Junction Temperature	110	110	110	$^\circ\text{C}$
Operating Temperature Range	-55 to +100	-55 to +100	-20 to +100	$^\circ\text{C}$
Storage Temperature Range			-55 to +100	
Lead Soldering Temperature [1.6 mm (0.063 in.) from body]	260 $^\circ\text{C}$ for 5 seconds			

### Notes:

- See Figure 2 to establish pulsed operating conditions.
- For Red and Green series derate linearly from 50 $^\circ\text{C}$  at 0.5 mA/ $^\circ\text{C}$ . For Yellow series derate linearly from 50 $^\circ\text{C}$  at 0.2 mA/ $^\circ\text{C}$ .
- The transient peak current is the maximum non-recurring peak current the devices can withstand without damaging the LED die and wire bonds. It is not recommended that the device be operated at peak currents beyond the Absolute Maximum Peak Forward Current.

Electrical/Optical Characteristics at  $T_A = 25^\circ\text{C}$ 

Symbol	Description	T-1 <sup>3/4</sup>	T-1 <sup>3/4</sup> Low Dome	T-1	Min.	Typ.	Max.	Units	Test Conditions
$\lambda_{\text{PEAK}}$	Peak Wavelength	3750 3850 3950 D640	3390 3490 3590	1340 1440 1540 K640		635 583 565 558		nm	Measurement at Peak
$\lambda_d$	Dominant Wavelength	3750 3850 3950 D640	3390 3490 3590	1340 1440 1540 K640		626 585 569 560		nm	Note 1
$\Delta\lambda^{1/2}$	Spectral Line Halfwidth	3750 3850 3950 D640	3390 3490 3590	1340 1440 1540 K640		40 36 28 24		nm	
$\tau_s$	Speed of Response	3750 3850 3950 D640	3390 3490 3590	1340 1440 1540 K640		90 90 500 3100		ns	
C	Capacitance	3750 3850 3950 D640	3390 3490 3590	1340 1440 1540 K640		11 15 18 35		pF	$V_F = 0, f = 1 \text{ MHz}$
$R\theta_{\text{J-PIN}}$	Thermal Resistance	3750 3850 3950 D640	3390 3490 3590	1340 1440 1540 K640		210 210 210 510 290 290 290 290		$^\circ\text{C/W}$	Junction to Cathode Lead
$V_F$	Forward Voltage	3750 3850 3950 D640	3390 3490 3590	1340 1440 1540 K640	1.5 1.5 1.5	1.9 2.1 2.2 2.2	2.6 2.6 3.0 3.0	V	$I_F = 20 \text{ mA}$ (Figure 3)
$V_R$	Reverse Breakdown Voltage	3750 3850 3950 D640	3390 3490 3590	1340 1440 1540 K640	5.0			V	$I_F = 100 \mu\text{A}$
$\eta_V$	Luminous Efficacy	3750 3850 3950 D640	3390 3490 3590	1340 1440 1540 K640		145 500 595 655		$\frac{\text{lumens}}{\text{watt}}$	Note 2

**Notes:**

1. The dominant wavelength,  $\lambda_d$ , is derived from the CIE chromaticity diagram and represents the single wavelength which defines the color of the device.
2. The radiant intensity,  $I_e$ , in watts per steradian, may be found from the equation  $I_e = I_v/\eta_V$ , where  $I_v$  is the luminous intensity in candelas and  $\eta_V$  is the luminous efficacy in lumens/watt.

# Red, Yellow, and Green

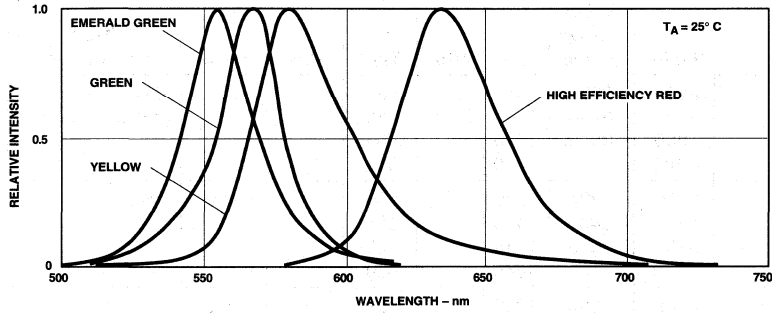

Figure 1. Relative Intensity vs. Wavelength.

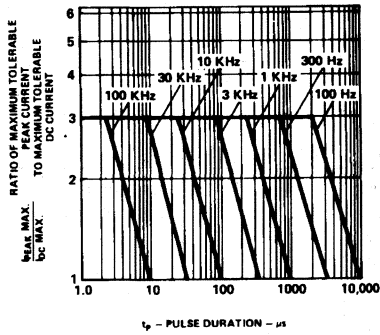

Figure 2. Maximum Tolerable Peak Current vs. Pulse Duration. ( $I_{DC}$  MAX as per MAX Ratings).

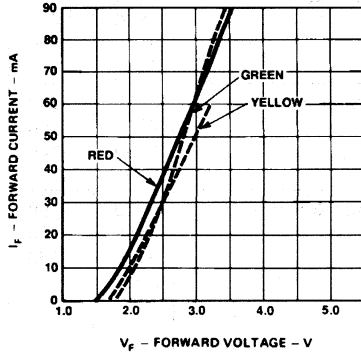

Figure 3. Forward Current vs. Forward Voltage.

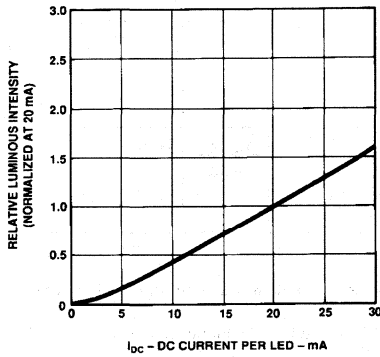

Figure 4. Relative Luminous Intensity vs. Forward Current.

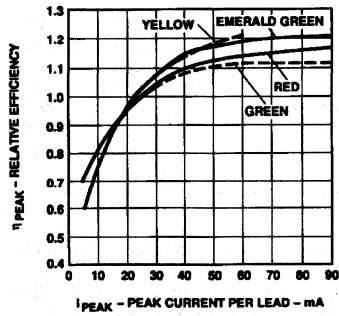

Figure 5. Relative Efficiency (Luminous Intensity per Unit Current) vs. Peak Current.

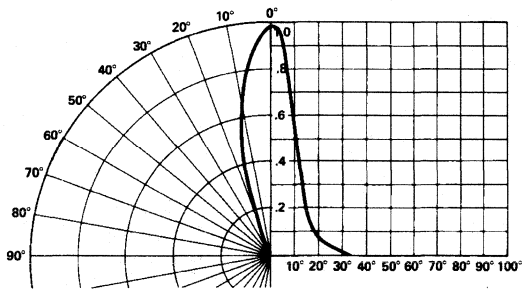

Figure 6. Relative Luminous Intensity vs. Angular Displacement. T-1<sup>3/4</sup> Lamp.

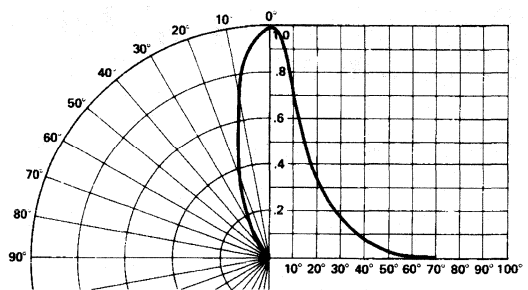

Figure 7. Relative Luminous Intensity vs. Angular Displacement. T-1<sup>3/4</sup> Low Profile Lamp.

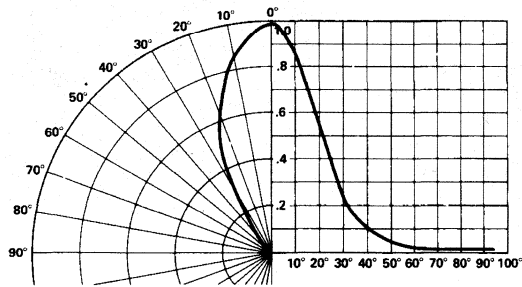

Figure 8. Relative Luminous Intensity vs. Angular Displacement. T-1 Lamp.

# T-1<sup>3</sup>/<sub>4</sub> (5 mm) High Intensity LED Lamps

## Technical Data

**HLMP-331X Series**  
**HLMP-341X Series**  
**HLMP-351X Series**

### Features

- **High Intensity**
- **Choice of 3 Bright Colors**  
High Efficiency Red  
Yellow  
High Performance Green
- **Popular T-1<sup>3</sup>/<sub>4</sub> Diameter Package**
- **Selected Minimum Intensities**
- **Narrow Viewing Angle**
- **General Purpose Leads**

- **Reliable and Rugged**
- **Available on Tape and Reel**

### Description

This family of T-1<sup>3</sup>/<sub>4</sub> nondiffused LED lamps is specially designed for applications requiring higher on-axis intensity than is achievable with a standard lamp. The light generated is focused to a narrow beam to achieve this effect.

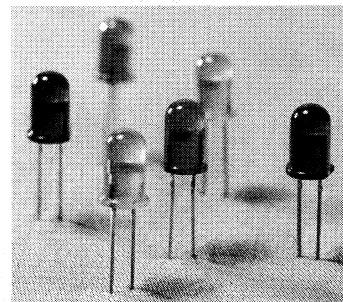

### Selection Guide

Part Number HLMP-	Description	Minimum Intensity (mcd) at 10 mA	Color (Material)
3315	Illuminator/ Point Source	13.8	High Efficiency Red (GaAsP on GaP)
3316	Illuminator/ High Brightness	22	
3415	Illuminator/ Point Source	9.2	Yellow (GaAsP on GaP)
3416	Illuminator/ High Brightness	14.7	
3517	Illuminator/ Point Source	6.7	Green (GaP)
3519	Illuminator/ High Brightness	10.6	

### Package Dimensions

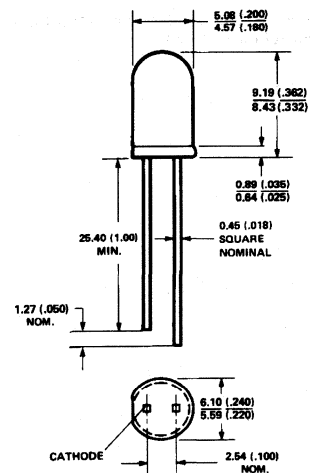

- NOTES:  
1. ALL DIMENSIONS ARE IN MILLIMETRES (INCHES).  
2. AN EPOXY MENISCUS MAY EXTEND ABOUT 1mm (.040") DOWN THE LEADS.

Electrical Characteristics at  $T_A = 25^\circ\text{C}$ 

Symbol	Description	Device HLMP-	Min.	Typ.	Max.	Units	Test Conditions		
$I_V$	Luminous Intensity	3315	13.8	40.0		mcd	$I_F = 10\text{ mA}$ (Figure 3)		
		3316	22	60.0					
		3415 3416	9.2 14.7	40.0 50.0		mcd	$I_F = 10\text{ mA}$ (Figure 8)		
		3517 3519	6.7 10.6	50.0 70.0		mcd	$I_F = 10\text{ mA}$ (Figure 13)		
		3315 3316		35 35		Deg.	$I_F = 10\text{ mA}$ See Note 1 (Figure 6)		
		3415 3416		35 35		Deg.	$I_F = 10\text{ mA}$ See Note 1 (Figure 11)		
$2\theta_{1/2}$	Including Angle Between Half Luminous Intensity Points	3517 3519		24 24		Deg.	$I_F = 10\text{ mA}$ See Note 1 (Figure 16)		
		$\lambda_{\text{PEAK}}$	Peak Wavelength	331X 341X 351X		635 583 565		nm	Measurement at Peak (Figure 1)
		$\Delta\lambda_{1/2}$	Spectral Line Halfwidth	331X 341X 351X		40 36 28		nm	
$\lambda_d$	Dominant Wavelength	331X 341X 351X		626 585 569		nm	See Note 2 (Figure 1)		
$\tau_s$	Speed of Response	331X 341X 351X		90 90 500		ns			
C	Capacitance	331X 341X 351X		11 15 18		pF	$V_F = 0; f = 1\text{ MHz}$		
$R\theta_{J-PIN}$	Thermal Resistance	331X 341X 351X		260		$^\circ\text{C/W}$	Junction to Cathode Lead		
$V_F$	Forward Voltage	331X 341X 351X		1.9 2.0 2.1	2.4 2.4 2.7	V	$I_F = 10\text{ mA}$ (Figure 2) $I_F = 10\text{ mA}$ (Figure 7) $I_F = 10\text{ mA}$ (Figure 12)		
$V_R$	Reverse Breakdown Volt.	All	5.0			V	$I_R = 100\text{ }\mu\text{A}$		
$\eta_V$	Luminous Efficacy	331X 341X 351X		145 500 595		lumens Watt	See Note 3		

**Notes:**

- $\theta_{1/2}$  is the off-axis angle at which the luminous intensity is half the axial luminous intensity.
- The dominant wavelength,  $\lambda_d$ , is derived from the CIE chromaticity diagram and represents the single wavelength which defines the color of the device.
- Radiant intensity,  $I_e$ , in watts/steradian, may be found from the equation  $I_e = I_V/\eta_V$ , where  $I_V$  is the luminous intensity in candelas and  $\eta_V$  is the luminous efficacy in lumens/watt.

## Absolute Maximum Ratings at $T_A = 25^\circ\text{C}$

Parameter	331X Series	341X Series	351X Series	Units
Peak Forward Current	90	60	90	mA
Average Forward Current <sup>[1]</sup>	25	20	25	mA
DC Current <sup>[2]</sup>	30	20	30	mA
Power Dissipation <sup>[3]</sup>	135	85	135	mW
Reverse Voltage ( $I_R = 100 \mu\text{A}$ )	5	5	5	V
Transient Forward Current <sup>[4]</sup> (10 $\mu\text{sec}$ Pulse)	500	500	500	mA
LED Junction Temperature	110	110	110	$^\circ\text{C}$
Operating Temperature Range	-55 to +100	-55 to +100	-20 to +100	$^\circ\text{C}$
Storage Temperature Range			-55 to +100	
Lead Soldering Temperature [1.6 mm (0.063 in.) from body]	260 $^\circ\text{C}$ for 5 seconds			

### Notes:

- See Figure 5 (Red), 10 (Yellow), or 15 (Green) to establish pulsed operating conditions.
- For Red and Green series derate linearly from 50 $^\circ\text{C}$  at 0.5 mA/ $^\circ\text{C}$ . For Yellow series derate linearly from 50 $^\circ\text{C}$  at 0.2 mA/ $^\circ\text{C}$ .
- For Red and Green series derate power linearly from 25 $^\circ\text{C}$  at 1.8 mW/ $^\circ\text{C}$ . For Yellow series derate power linearly from 50 $^\circ\text{C}$  at 1.6 mW/ $^\circ\text{C}$ .
- The transient peak current is the maximum non-recurring peak current that can be applied to the device without damaging the LED die and wirebond. It is not recommended that the device be operated at peak currents beyond the peak forward current listed in the Absolute Maximum Ratings.

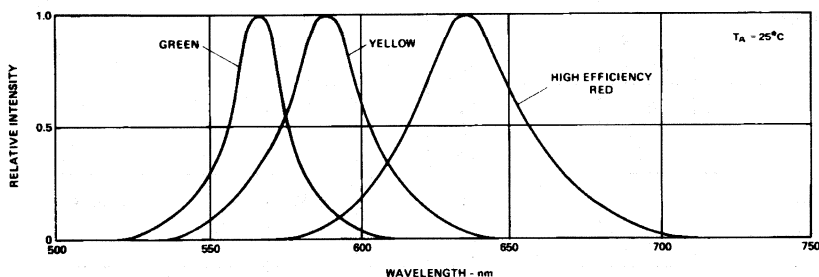

Figure 1. Relative Intensity vs. Wavelength.



## High Efficiency Red HLMP-331X Series

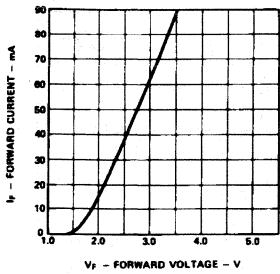

Figure 2. Forward Current vs. Forward Voltage Characteristics.

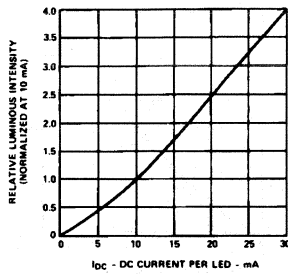

Figure 3. Relative Luminous Intensity vs. DC Forward Current.

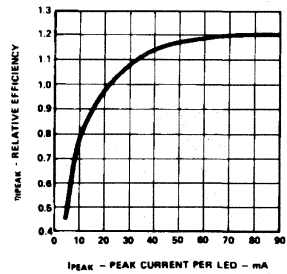

Figure 4. Relative Efficiency (Luminous Intensity per Unit Current) vs. Peak LED Current.

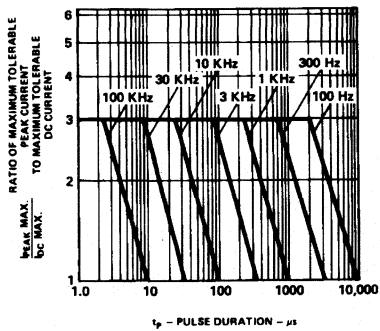

Figure 5. Maximum Tolerable Peak Current vs. Pulse Duration ( $I_{DC}$  MAX as per MAX Ratings).

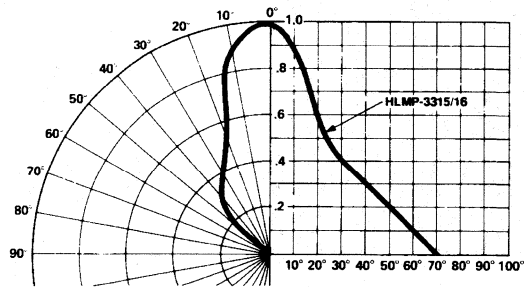

Figure 6. Relative Luminous Intensity vs. Angular Displacement.

# Yellow HLMP-341X Series

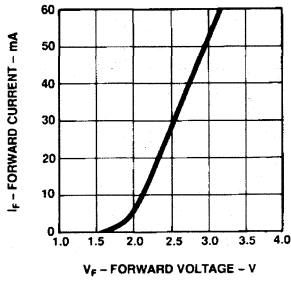

Figure 7. Forward Current vs. Forward Voltage Characteristics.

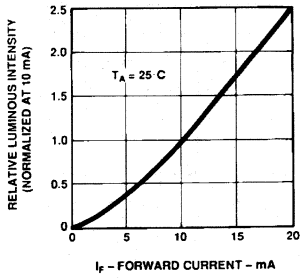

Figure 8. Relative Luminous Intensity vs. DC Forward Current.

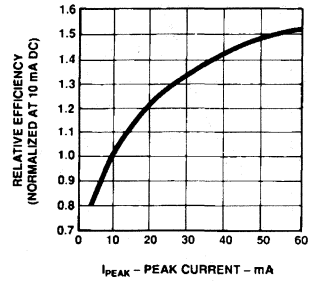

Figure 9. Relative Efficiency (Luminous Intensity per Unit Current) vs. Peak Current.

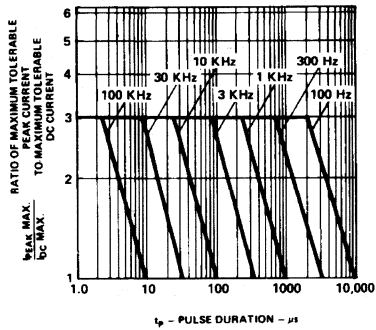

Figure 10. Maximum Tolerable Peak Current vs. Pulse Duration ( $I_{DC\ MAX}$  as per MAX Ratings).

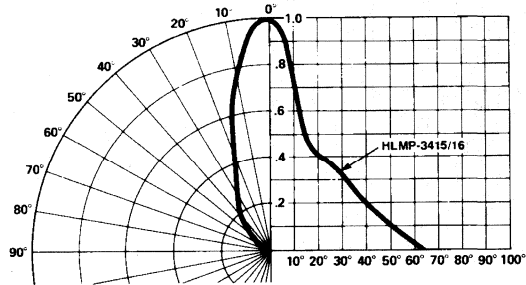

Figure 11. Relative Luminous Intensity vs. Angular Displacement.

# Green HLMP-351X Series

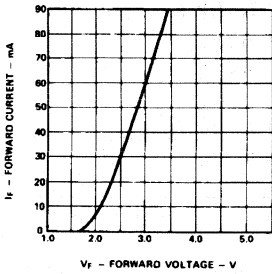

Figure 12. Forward Current vs. Forward Voltage Characteristics.

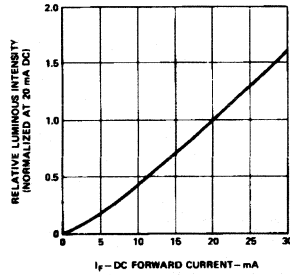

Figure 13. Relative Luminous Intensity vs. DC Forward Current.

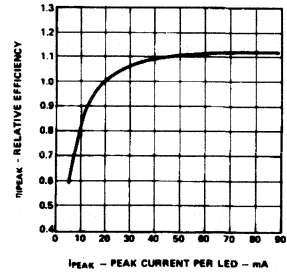

Figure 14. Relative Efficiency (Luminous Intensity per Unit Current) vs. Peak LED Current.

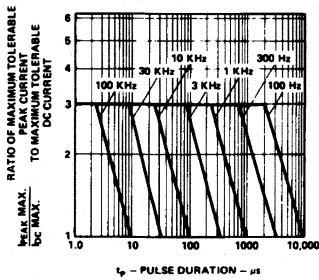

Figure 15. Maximum Tolerable Peak Current vs. Pulse Duration ( $I_{DC}$  MAX as per MAX Ratings).

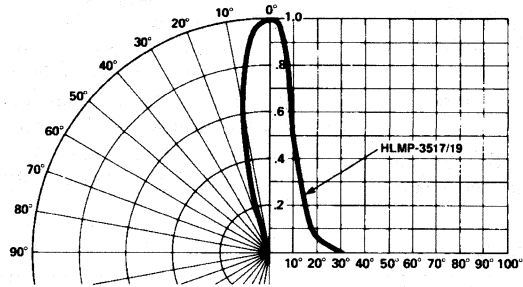

Figure 16. Relative Luminous Intensity vs. Angular Displacement.  $T-1\frac{3}{4}$  Lamp.

LED LAMPS AND INDICATORS

# T-1<sup>3</sup>/<sub>4</sub> (5 mm) Diffused LED Lamps

## Technical Data

**HLMP-3300 Series**  
**HLMP-3400 Series**  
**HLMP-3500 Series**  
**HLMP-3762**  
**HLMP-3862**  
**HLMP-3962**  
**HLMP-D400 Series**  
**HLMP-D600**

### Features

- **High Intensity**
- **Choice of 4 Bright Colors**  
 High Efficiency Red  
 Orange  
 Yellow  
 High Performance Green
- **Popular T-1<sup>3</sup>/<sub>4</sub> Diameter Package**
- **Selected Minimum Intensities**
- **Wide Viewing Angle**
- **General Purpose Leads**

- **Reliable and Rugged**
- **Available on Tape and Reel**

### Description

This family of T-1<sup>3</sup>/<sub>4</sub> tinted, diffused LED lamps is widely used in general purpose indicator applications. Diffusants, tints, and optical design are balanced to yield superior light output and wide viewing angles. Several intensity choices are available in each color for increased design flexibility.

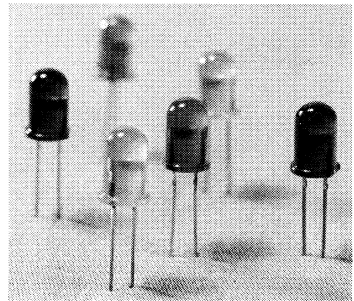

### Selection Guide

Part Number HLMP-	Application	Minimum Intensity (mcd) at 10 mA	Color (Material)
3300	General Purpose	2.1	High Efficiency Red (GaAsP on GaP)
3301	High Ambient	5.4	
3762	Premium Lamp	8.6	
D400	General Purpose	2.1	Orange (GaAsP on GaP)
D401	High Ambient	5.4	
3400	General Purpose	2.2	Yellow (GaAsP on GaP)
3401	High Ambient	5.7	
3862	Premium Lamp	9.2	
3502	General Purpose	1.6	Green (GaP) 565 nm
3507	High Ambient	4.2	
3962	Premium Lamp	10.6	
D600 <sup>[1]</sup>	General Purpose	1.0	Emerald Green (GaP) 558 nm

#### Note:

1. Please refer to Application Note 1061 for information comparing standard green and emerald green light output degradation.

## Package Dimensions

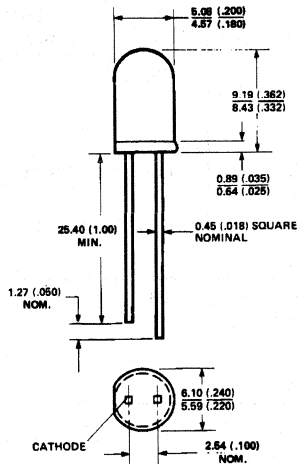

- NOTES:  
 1. ALL DIMENSIONS ARE IN MILLIMETRES (INCHES).  
 2. AN EPOXY MENISCUS MAY EXTEND ABOUT 1mm (.040") DOWN THE LEADS.

## Optical/Electrical Characteristics at $T_A = 25^\circ\text{C}$

Symbol	Parameter	Device HLMP-	Min.	Typ.	Max.	Units	Test Conditions
$I_V$	Luminous Intensity	High Efficiency Red				mcd	$I_F = 10 \text{ mA}$
		3300	2.1	3.5			
		3301	5.4	7.0			
		3762	8.6	12.0			
		Orange					
D400	2.1	3.5					
D401	5.4	7.0					
Yellow		3400	2.2	4.0			
		3401	5.7	8.0			
		3862	9.2	12.0			
		Green					
3502	1.6	2.4					
3507	4.2	5.2					
3962	10.6	14.0					
Emerald Green		D600	1.0	3.0			
$2\theta^{1/2}$	Included Angle Between Half Luminous Intensity Points	High Efficiency Red Orange Yellow Green Emerald Green		60 60 60 60 60		Deg.	$I_F = 10 \text{ mA}$ See Note 1
$\lambda_{PEAK}$	Peak Wavelength	High Efficiency Red Orange Yellow Green Emerald Green		635 600 583 565 558		nm	Measurement at Peak

### Optical/Electrical Characteristics at $T_A = 25^\circ\text{C}$ (cont.)

Symbol	Parameter	Device HLMP-	Min.	Typ.	Max.	Units	Test Conditions
$\Delta\lambda_{1/2}$	Spectral Line Halfwidth	HER/Orange Yellow Green Emerald Green		40 36 28 24		nm	
$\lambda_d$	Dominant Wavelength	High Efficiency Red Orange Yellow Green Emerald Green		626 602 585 569 560		nm	See Note 2
$\tau_s$	Speed of Response	High Efficiency Red Orange Yellow Green Emerald Green		90 280 90 500 560		ns	
C	Capacitance	High Efficiency Red Orange Yellow Green Emerald Green		11 4 15 18 3100		pF	$V_F = 0$ ; $f = 1 \text{ MHz}$
$R\theta_{J-PIN}$	Thermal Resistance	All		260		$^\circ\text{C/W}$	Junction to Cathode Lead
$V_F$	Forward Voltage	HER/Orange Yellow Green Emerald Green		1.9 2.0 2.1 2.1	2.4 2.4 2.7 2.7	V	$I_F = 10 \text{ mA}$
$V_R$	Reverse Breakdown Voltage	All	5.0			V	$I_R = 100 \mu\text{A}$
$\eta_v$	Luminous Efficacy	High Efficiency Red Orange Yellow Green Emerald Green	- -	145 380 500 595 656		<u>lumens</u> Watt	See Note 3

#### Notes:

- $\theta^{1/2}$  is the off-axis angle at which the luminous intensity is half the axial luminous intensity.
- The dominant wavelength,  $\lambda_d$ , is derived from the CIE chromaticity diagram and represents the single wavelength which defines the color of the device.
- Radiant intensity,  $I_e$ , in Watts/steradian, may be found from the equation  $I_e = I_v/\eta_v$ , where  $I_v$  is the luminous intensity in candelas and  $\eta_v$  is the luminous efficacy in lumens/Watt.

### Absolute Maximum Ratings at $T_A = 25^\circ\text{C}$

Parameter	HER/Orange	Yellow	Green/ Emerald Green	Units
Peak Forward Current	90	60	90	mA
Average Forward Current <sup>[1]</sup>	25	20	25	mA
DC Current <sup>[2]</sup>	30	20	30	mA
Power Dissipation <sup>[3]</sup>	135	85	135	mW
Reverse Voltage ( $I_R = 100 \mu\text{A}$ )	5	5	5	V
Transient Forward Current <sup>[4]</sup> (10 $\mu\text{sec}$ Pulse)	500	500	500	mA
LED Junction Temperature	110	110	110	$^\circ\text{C}$
Operating Temperature Range	-55 to +100	-55 to +100	-20 to +100	$^\circ\text{C}$
Storage Temperature Range			-55 to +100	
Lead Soldering Temperature [1.6 mm (0.063 in.) from body]	260 $^\circ\text{C}$ for 5 seconds			

**Notes:**

- See Figure 5 (Red/Orange), 10 (Yellow), or 15 (Green) to establish pulsed operating conditions.
- For Red, Orange and Green series derate linearly from 50 $^\circ\text{C}$  at 0.5 mA/ $^\circ\text{C}$ . For Yellow series derate linearly from 50 $^\circ\text{C}$  at 0.2 mA/ $^\circ\text{C}$ .
- 1.8 mW/ $^\circ\text{C}$ . For Yellow series derate power linearly from 50 $^\circ\text{C}$  at 1.6 mW/ $^\circ\text{C}$ .
- The transient peak current is the maximum non-recurring peak current that can be applied to the device without damaging the LED die and wirebond. It is not recommended that the device be operated at peak currents beyond the peak forward current listed in the Absolute Maximum Ratings.

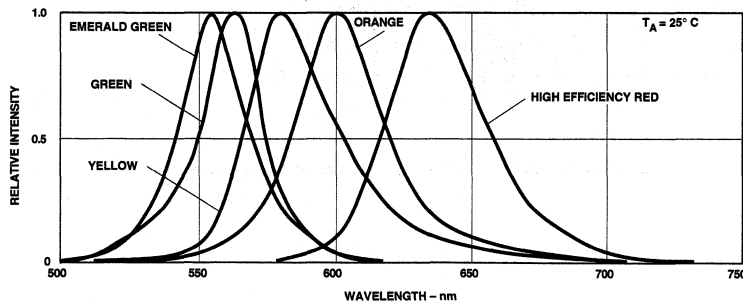

Figure 1. Relative Intensity vs. Wavelength.

# T-1<sup>3/4</sup> High Efficiency Red, Orange Diffused Lamps

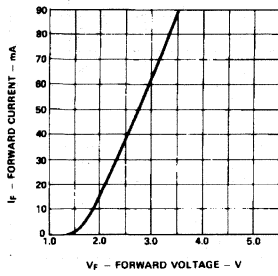

Figure 2. Forward Current vs. Forward Voltage Characteristics.

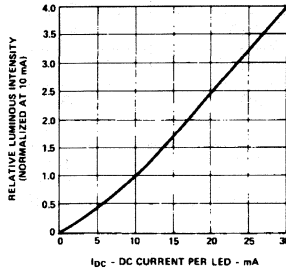

Figure 3. Relative Luminous Intensity vs. DC Forward Current.

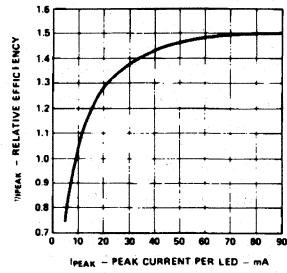

Figure 4. Relative Efficiency (Luminous Intensity per Unit Current) vs. Peak LED Current.

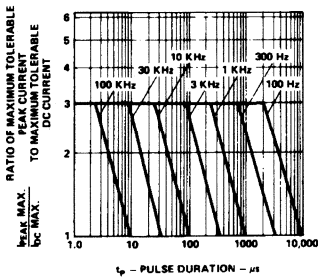

Figure 5. Maximum Tolerable Peak Current vs. Pulse Duration. ( $I_{DC}$  MAX as per MAX Ratings).

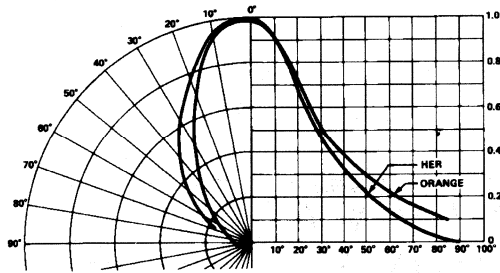
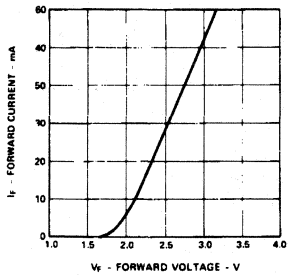

Figure 6. Relative Luminous Intensity vs. Angular Displacement.



## T-1<sup>3/4</sup> Yellow Diffused Lamps



**Figure 7. Forward Current vs. Forward Voltage Characteristics.**

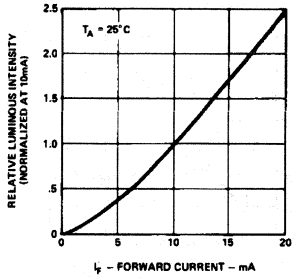

**Figure 8. Relative Luminous Intensity vs. Forward Current.**

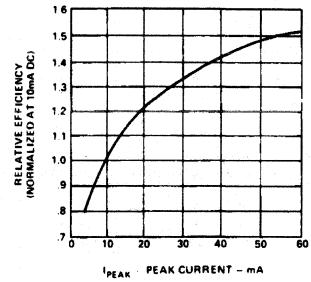

**Figure 9. Relative Efficiency (Luminous Intensity per Unit Current) vs. Peak Current.**

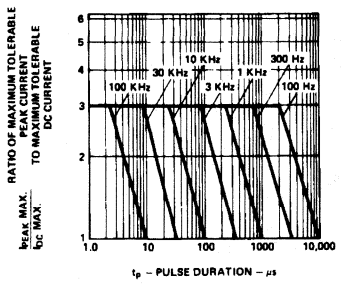

**Figure 10. Maximum Tolerable Peak Current vs. Pulse Duration. ( $I_{DC}$  MAX as per MAX Ratings).**

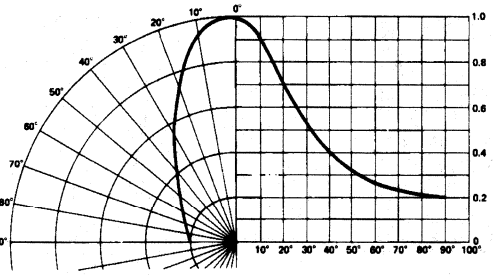

**Figure 11. Relative Luminous Intensity vs. Angular Displacement.**

# T-1<sup>3</sup>/<sub>4</sub> Green/Emerald Green Diffused Lamps

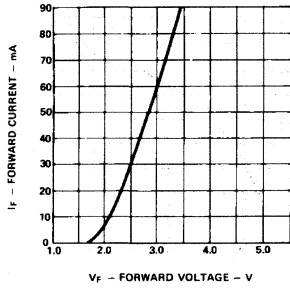

Figure 12. Forward Current vs. Forward Voltage Characteristics.

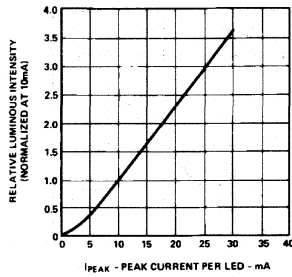

Figure 13. Relative Luminous Intensity vs. DC Forward Current.

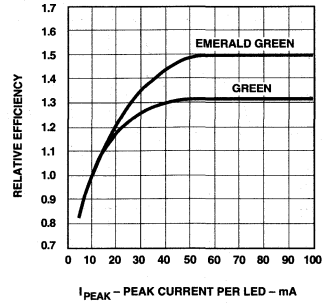

Figure 14. Relative Efficiency (Luminous Intensity per Unit Current) vs. Peak LED Current.

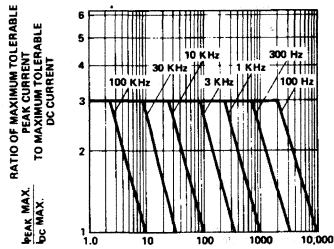

Figure 15. Maximum Tolerable Peak Current vs. Pulse Duration. ( $I_{DC}$  MAX as per MAX Ratings).

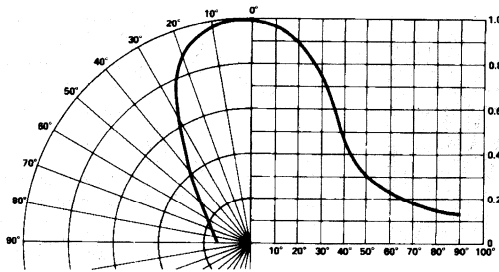

Figure 16. Relative Luminous Intensity vs. Angular Displacement.

# T-1<sup>3</sup>/<sub>4</sub> (5 mm) Low Profile LED Lamps

## Technical Data

HLMP-335X Series  
HLMP-336X Series  
HLMP-345X Series  
HLMP-346X Series  
HLMP-355X Series  
HLMP-356X Series

### Features

- High Intensity
- Low Profile: 5.8 mm (0.23 in.) Nominal
- T-1<sup>3</sup>/<sub>4</sub> Diameter Package
- Diffused and Non-diffused Types
- General Purpose Leads
- IC Compatible/Low Current Requirements
- Reliable and Rugged

The HLMP-355X/356X Series are Gallium Phosphide Green Light Emitting Diodes.

The Low Profile T-1<sup>3</sup>/<sub>4</sub> package provides space savings and is excellent for backlighting applications.

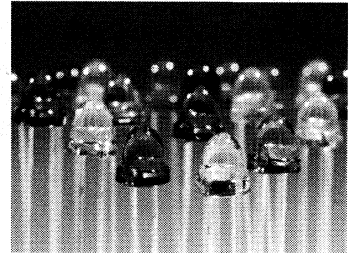

### Description

The HLMP-335X/336X Series are Gallium Arsenide Phosphide on Gallium Phosphide High Efficiency Red Light Emitting Diodes.

The HLMP-345X/346X Series are Gallium Arsenide Phosphide on Gallium Phosphide Yellow Light Emitting Diodes.

### Package Dimensions

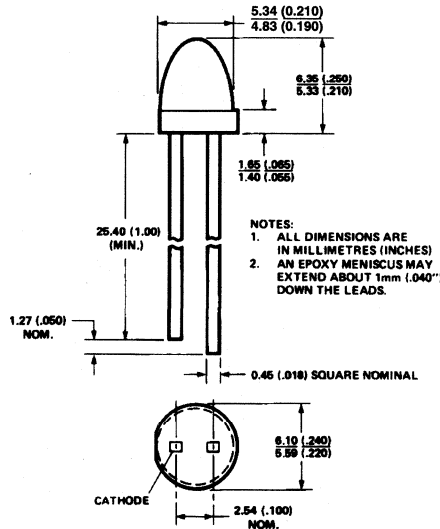

## Selection Guide

<b>Part Number HLMP-</b>	<b>Application</b>	<b>Minimum Intensity @ 10 mA (mcd)</b>	<b>Lens</b>
3350	Indicator – General Purpose	2.1	Tinted Diffused Wide Angle
3351	Indicator – High Brightness	5.4	HER
3365	General Purpose Point Source	8.6	Tinted Non-diffused Narrow Angle
3366	Indicator – High Brightness	13.8	HER
3450	Indicator – General Purpose	2.2	Tinted Diffused Wide Angle
3451	Indicator – High Brightness	5.7	Yellow
3465	General Purpose Point Source	5.7	Tinted Non-diffused Narrow Angle
3466	Indicator – High Brightness	9.2	Yellow
3553	Indicator – General Purpose	1.6	Tinted Diffused Wide Angle
3554	Indicator – High Brightness	6.7	Green
3567	General Purpose Point Source	4.2	Tinted Non-diffused Narrow Angle
3568	Indicator – High Brightness	10.6	Green

## High Efficiency Red HLMP-335X/-336X Series Electrical Specifications at $T_A = 25^\circ\text{C}$

Symbol	Description	Device HLMP-	Min.	Typ.	Max.	Units	Test Conditions
$I_V$	Axial Luminous Intensity	3350 3351 3365 3366	2.1 5.4 8.6 13.8	3.5 7.0 10.0 18.0		mcd	$I_F = 10\text{ mA}$ (Figure 8)
$2\theta^{1/2}$	Including Angle Between Half Luminous Intensity Points	3350 3351 3365 3366		50 50 45 45		Deg.	Note 1 (Figure 11)
$\lambda_{\text{PEAK}}$	Peak Wavelength			635		nm	Measurement at Peak (Figure 1)
$\lambda_d$	Dominant Wavelength			626		nm	Note 2
$\Delta\lambda_{1/2}$	Spectral Line Halfwidth			40		nm	
$\tau_s$	Speed of Response			90		ns	
C	Capacitance			11		pF	$V_F = 0$ ; $f = 1\text{ MHz}$
$R\theta_{\text{J-PIN}}$	Thermal Resistance			260		$^\circ\text{C/W}$	Junction to Cathode Lead
$V_F$	Forward Voltage			1.9	2.4	V	$I_F = 10\text{ mA}$ (Figure 7)
$V_R$	Reverse Breakdown Voltage		5.0			V	$I_R = 100\text{ }\mu\text{A}$
$\eta_V$	Luminous Efficacy			145		lm/W	Note 3

**Notes:**

- $\theta^{1/2}$  is the off-axis angle at which the luminous intensity is half the axial luminous intensity.
- Dominant wavelength,  $\lambda_d$ , is derived from the CIE chromaticity diagram and represents the single wavelength which defines the color of the device.
- Radiant Intensity,  $I_e$ , in watts/steradian may be found from the equation  $I_e = I_V/\eta_V$ , where  $I_V$  is the luminous intensity in candelas and  $\eta_V$  is the luminous efficacy in lumens/watt.

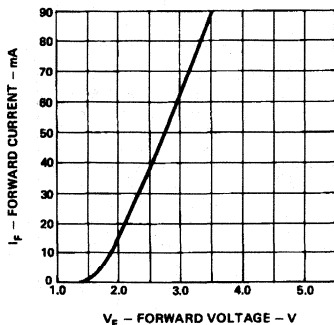

**Figure 7. Forward Current vs. Forward Voltage.**

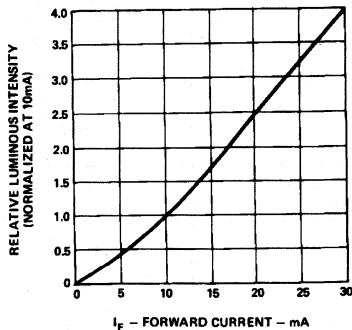

**Figure 8. Relative Luminous Intensity vs. Forward Current.**

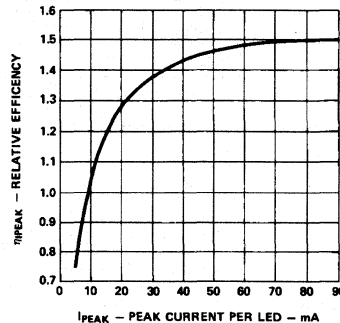

**Figure 9. Relative Efficiency (Luminous Intensity per Unit Current) vs. Peak Current.**

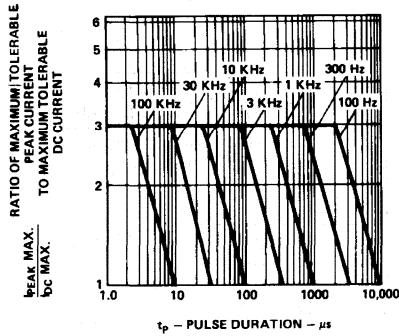

Figure 10. Maximum Tolerable Peak Current vs. Pulse Duration. ( $I_{DC}$  MAX as per MAX Ratings).

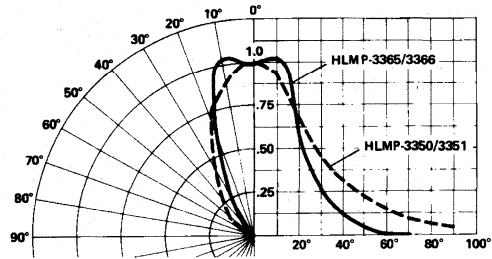

Figure 11. Relative Luminous Intensity vs. Angular Displacement.

### Yellow HLMP-345X/-346X Series Electrical Specifications at $T_A = 25^\circ\text{C}$

Symbol	Description	Device HLMP-	Min.	Typ.	Max.	Units	Test Conditions
$I_V$	Axial Luminous Intensity	3450 3451 3465 3466	2.2 5.7 5.7 9.2	4.0 10.0 12.0 18.0		mc	$I_F = 10$ mA (Figure 13)
$2\theta_{1/2}$	Including Angle Between Half Luminous Intensity Points	3450 3451 3465 3466		50 50 45 45		Deg.	Note 1 (Figure 16)
$\lambda_{PEAK}$	Peak Wavelength			583		nm	Measurement at Peak (Figure 1)
$\lambda_d$	Dominant Wavelength			585		nm	Note 2
$\Delta\lambda_{1/2}$	Spectral Line Halfwidth			36		nm	
$\tau_s$	Speed of Response			90		ns	
C	Capacitance			15		pF	$V_F = 0$ ; $f = 1$ MHz
$R\theta_{J-PIN}$	Thermal Resistance			260		$^\circ\text{C}/\text{W}$	Junction to Cathode Lead
$V_F$	Forward Voltage			2.0	2.4	V	$I_F = 10$ mA (Figure 12)
$V_R$	Reverse Breakdown Voltage		5.0			V	$I_R = 100$ $\mu\text{A}$
$\eta_V$	Luminous Efficacy			500		lm/W	Note 3

**Notes:**

- $\theta_{1/2}$  is the off-axis angle at which the luminous intensity is half the axial luminous intensity.
- Dominant wavelength,  $\lambda_d$ , is derived from the CIE chromaticity diagram and represents the single wavelength which defines the color of the device.
- Radiant Intensity,  $I_e$ , in watts/steradian may be found from the equation  $I_e = I_v/\eta_v$ , where  $I_v$  is the luminous intensity in candelas and  $\eta_v$  is the luminous efficacy in lumens/watt.

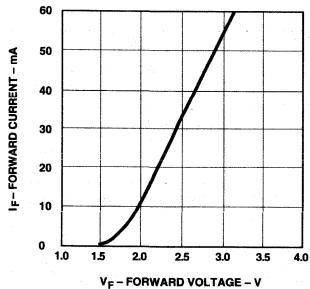

Figure 12. Forward Current vs. Forward Voltage.

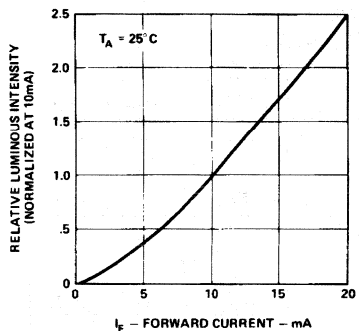

Figure 13. Relative Luminous Intensity vs. Forward Current.

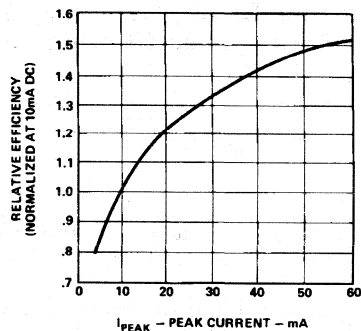

Figure 14. Relative Efficiency (Luminous Intensity per Unit Current) vs. Peak Current.

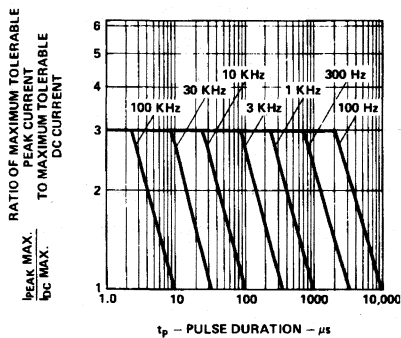

Figure 15. Maximum Tolerable Peak Current vs. Pulse Duration. ( $I_{DC}$  MAX as per MAX Ratings).

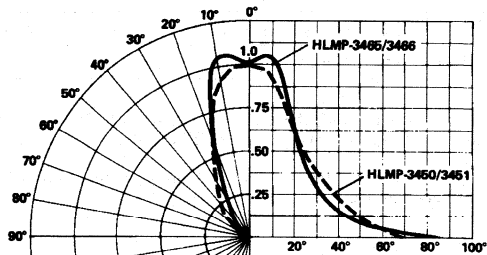

Figure 16. Relative Luminous Intensity vs. Angular Displacement.

**Green HLMP-355X/-356X Series**  
**Electrical Specifications at  $T_A = 25^\circ\text{C}$**

Symbol	Description	Device HLMP-	Min.	Typ.	Max.	Units	Test Conditions
$I_V$	Axial Luminous Intensity	3553 3554 3567 3568	1.6 6.7 4.2 10.6	3.2 10.0 7.0 15.0		mcd	$I_F = 10\text{ mA}$ (Figure 18)
$2\theta_{1/2}$	Including Angle Between Half Luminous Intensity Points	3553 3554 3567 3568		50 50 40 40		Deg.	Note 1 (Figure 21)
$\lambda_{\text{PEAK}}$	Peak Wavelength			565		nm	Measurement at Peak (Figure 1)
$\lambda_d$	Dominant Wavelength			569		nm	Note 2
$\Delta\lambda_{1/2}$	Spectral Line Halfwidth			28		nm	
$\tau_s$	Speed of Response			500		ns	
C	Capacitance			18		pF	$V_F = 0$ ; $f = 1\text{ MHz}$
$R\theta_{\text{J-PIN}}$	Thermal Resistance			260		$^\circ\text{C/W}$	Junction to Cathode Lead
$V_F$	Forward Voltage			2.1	2.7	V	$I_F = 10\text{ mA}$ (Figure 17)
$V_R$	Reverse Breakdown Voltage		5.0			V	$I_R = 100\ \mu\text{A}$
$\eta_V$	Luminous Efficacy			595		lm/W	Note 3

**Notes:**

- $\theta_{1/2}$  is the off-axis angle at which the luminous intensity is half the axial luminous intensity.
- Dominant wavelength,  $\lambda_d$ , is derived from the CIE chromaticity diagram and represents the single wavelength which defines the color of the device.
- Radiant Intensity,  $I_e$ , in watts/steradian may be found from the equation  $I_e = I_V/\eta_v$ , where  $I_V$  is the luminous intensity in candelas and  $\eta_v$  is the luminous efficacy in lumens/watt.

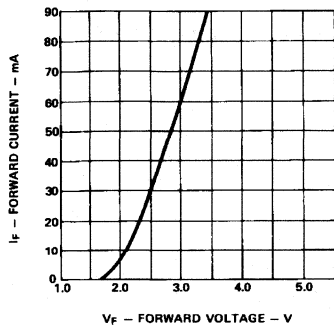

**Figure 17. Forward Current vs. Forward Voltage.**

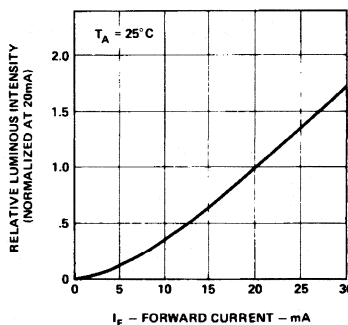

**Figure 18. Relative Luminous Intensity vs. Forward Current.**

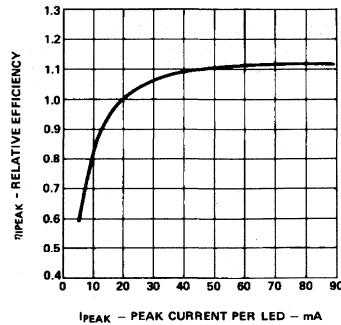

**Figure 19. Relative Efficiency (Luminous Intensity per Unit Current) vs. Peak Current.**



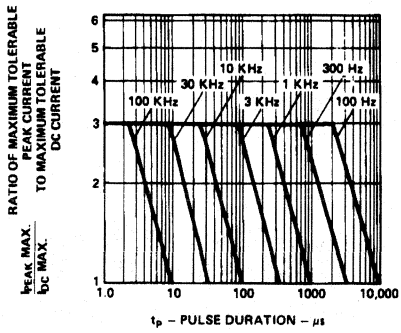

Figure 20. Maximum Tolerable Peak Current vs. Pulse Duration. ( $I_{DC}$  MAX as per MAX Ratings).

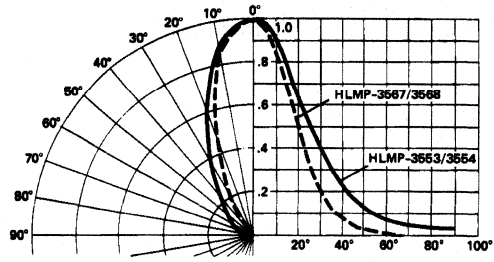

Figure 21. Relative Luminous Intensity vs. Angular Displacement.

# T-1<sup>3</sup>/<sub>4</sub> (5 mm), T-1 (3 mm), Low Current LED Lamps

## Technical Data

**HLMP-4700, -4719, -4740**  
**HLMP-1700, -1719, -1790**

### Features

- Low Power
- High Efficiency
- CMOS-MOS Compatible
- TTL Compatible
- Wide Viewing Angle
- Choice of Package Styles
- Choice of Colors

### Applications

- Low Power DC Circuits
- Telecommunications Indicators

- Portable Equipment
- Keyboard Indicators

### Description

These tinted diffused LED lamps are designed and optimized specifically for low DC current operation. Luminous intensity and forward voltage are tested at 2 mA to assure consistent brightness at TTL output current levels.

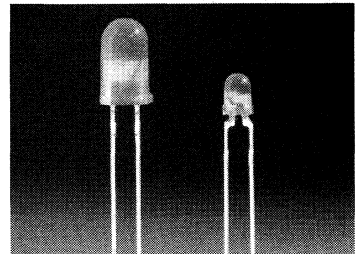

### Package Dimensions

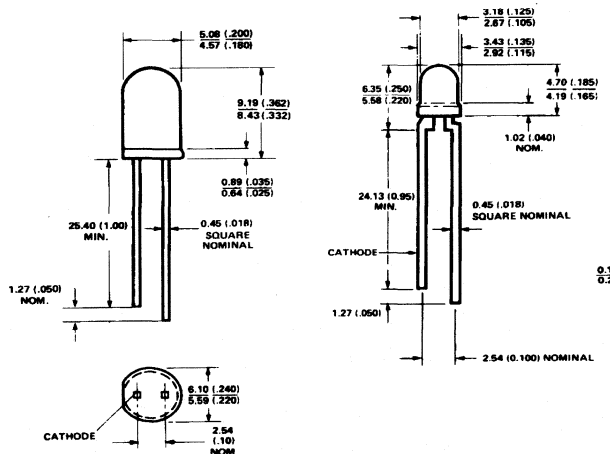

**NOTES:**  
1. ALL DIMENSIONS ARE IN MILLIMETRES (INCHES).  
2. AN EPOXY MINISCUS MAY EXTEND ABOUT 1 mm (0.040") DOWN THE LEADS.

HLMP-4700, -4719, -4740

HLMP-1700, -1719, -1790

A

B

### Low Current Lamp Selection Guide

Size	Color		
	HER HLMP-	Yellow HLMP-	Green HLMP-
T-1 <sup>3/4</sup>	4700	4719	4740
T-1	1700	1719	1790

### Axial Luminous Intensity and Viewing Angle @ 25°C

Part Number HLMP-	Package Description	Color	I <sub>v</sub> (mcd) @ 2 mA DC		2θ <sup>1/2</sup> [1]	Package Outline
			Min.	Typ.		
4700 4719 4740	T-1 <sup>3/4</sup> Tinted Diffused	Red Yellow Green	1.3 0.9 1.0	2.3 2.1 2.3	50°	A
1700 1719 1790	T-1 Tinted Diffused	Red Yellow Green	0.8 0.9 1.0	2.1 1.6 2.1	50°	B

**Note:**

1. θ<sup>1/2</sup> is the typical off-axis angle at which the luminous intensity is half the axial luminous intensity.

### Electrical/Optical Characteristics at $T_A = 25^\circ\text{C}$

Symbol	Description	T-1 <sup>3/4</sup>	T-1	Min.	Typ.	Max.	Units	Test Conditions
$V_F$	Forward Voltage	4700 4719 4740	1700 1719 1790		1.8 1.9 1.8	2.0 2.5 2.2	V	2 mA
$V_R$	Reverse Breakdown Voltage	4700 4719 4740	1700 1719 1790	5.0 5.0 5.0			V	$I_R = 50 \mu\text{A}$
$\lambda_d$	Dominant Wavelength	4700 4719 4740	1700 1719 1790		626 585 569		nm	Note 1
$\Delta\lambda_{1/2}$	Spectral Line Halfwidth	4700 4719 4740	1700 1719 1790		40 36 28		nm	
$\tau_S$	Speed of Response	4700 4719 4740	1700 1719 1790		90 90 500		ns	
C	Capacitance	4700 4719 4740	1700 1719 1790		11 15 18		pF	$V_F = 0,$ $f = 1 \text{ MHz}$
$R\theta_{J-PIN}$	Thermal Resistance	4700 4719 4740	1700 1719 1790		260 <sup>[3]</sup> 290 <sup>[4]</sup>		$^\circ\text{C/W}$	Junction to Cathode Lead
$\lambda_{PEAK}$	Peak Wavelength	4700 4719 4740	1700 1719 1790		635 583 565		nm	Measurement at peak
$\eta_V$	Luminous Efficacy	4700 4719 4740	1700 1719 1790		145 500 595		<u>lumens</u> watt	Note 2

#### Notes:

1. The dominant wavelength,  $\lambda_d$ , is derived from the CIE chromaticity diagram and represents the single wavelength which defines the color of the device.
2. The radiant intensity,  $I_e$ , in watts per steradian, may be found from the equation  $I_e = I_v/\eta_v$ , where  $I_v$  is the luminous intensity in candelas and  $\eta_v$  is luminous efficacy in lumens/watt.
3. T-1<sup>3/4</sup>.
4. T-1.

### Absolute Maximum Ratings

Parameter	Maximum Rating		Units
Power Dissipation (Derate linearly from 92°C at 1.0 mA/°C)	Red Yellow Green	24 36 24	mW
DC and Peak Forward Current	7		mA
Transient Forward Current (10 $\mu$ s Pulse) <sup>[1]</sup>	500		mA
Reverse Voltage ( $I_R = 50 \mu$ A)	5.0		V
Operating Temperature Range	Red/Yellow Green	-55°C to 100°C -20°C to 100°C	
Storage Temperature Range	-55°C to +100°C		
Lead Soldering Temperature [1.6 mm (0.063 in.) from body]	260°C for 5 seconds		

**Note:**

1. The transient peak current is the maximum non-recurring peak current the devices can withstand without damaging the LED die and wire bonds. It is not recommended that the device be operated at peak currents beyond the Absolute Maximum Peak Forward Current.

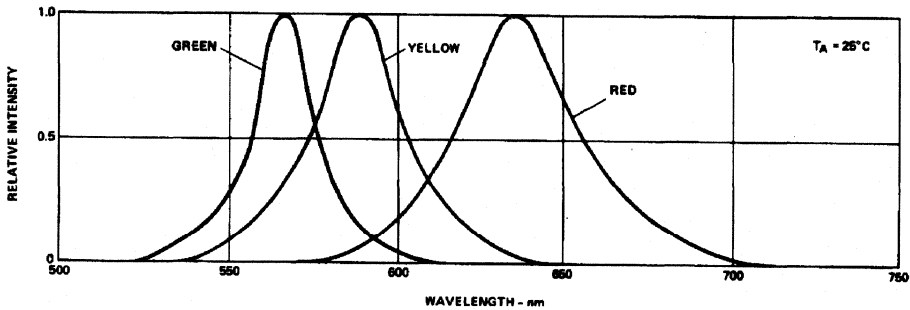

Figure 1. Relative Intensity vs. Wavelength.

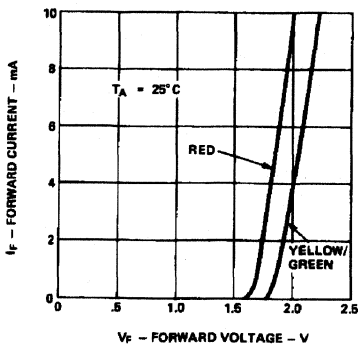

Figure 2. Forward Current vs. Forward Voltage.

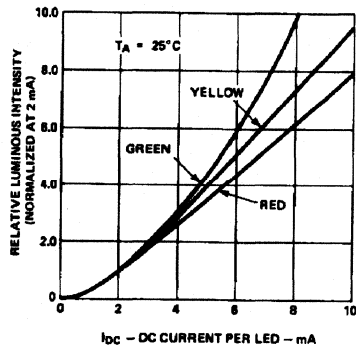
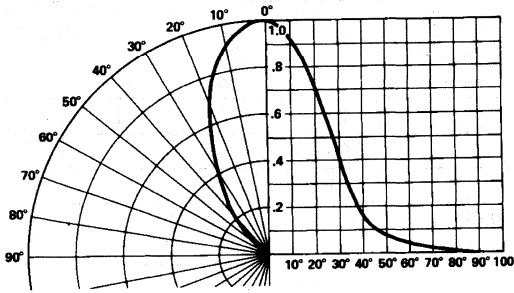
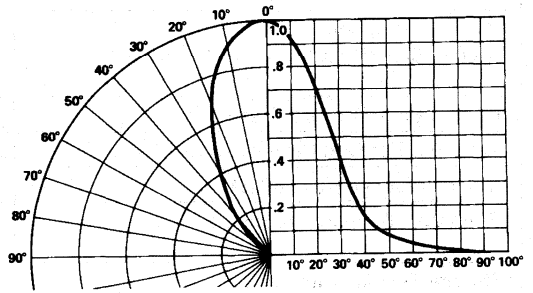

Figure 3. Relative Luminous Intensity vs. Forward Current.



**Figure 4. Relative Luminous Intensity vs. Angular Displacement for T-1<sup>3/4</sup> Lamp.**



**Figure 5. Relative Luminous Intensity vs. Angular Displacement for T-1 Lamp.**

# T-1<sup>3</sup>/<sub>4</sub> (5 mm), T-1 (3 mm), 5 Volt, 12 Volt, Integrated Resistor LED Lamps

## Technical Data

**HLMP-1600, HLMP-1601  
HLMP-1620, HLMP-1621  
HLMP-1640, HLMP-1641  
HLMP-3600, HLMP-3601  
HLMP-3650, HLMP-3651  
HLMP-3680, HLMP-3681**

### Features

- **Integral Current Limiting Resistor**
- **TTL Compatible**  
Requires no External Current Limiter with 5 Volt/12 Volt Supply
- **Cost Effective**  
Saves Space and Resistor Cost
- **Wide Viewing Angle**
- **Available in All Colors**  
Red, High Efficiency Red, Yellow, and High Performance Green in T-1 and T-1<sup>3</sup>/<sub>4</sub> Packages

### Description

The 5 volt and 12 volt series lamps contain an integral current limiting resistor in series with the LED. This allows the lamp to be driven from a 5 volt/12 volt source without an external current limiter. The red LEDs are made from GaAsP on a GaAs substrate. The High Efficiency Red and Yellow devices use GaAsP on a GaP substrate.

The green devices use GaP on a GaP substrate. The diffused lamps provide a wide off-axis viewing angle.

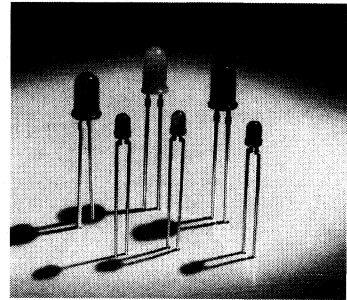

The T-1<sup>3</sup>/<sub>4</sub> lamps are provided with sturdy leads suitable for wire wrap applications. The T-1<sup>3</sup>/<sub>4</sub> lamps may be front panel mounted by using the HLMP-0103 clip and ring.

### Package Dimensions

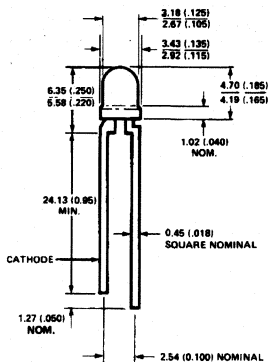

Figure A. T-1 Package.

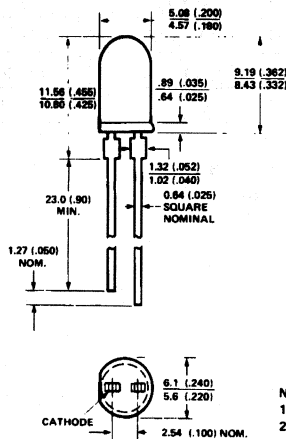

Figure B. T-1<sup>3</sup>/<sub>4</sub> Package.

NOTES:  
1. ALL DIMENSIONS ARE IN MILLIMETRES (INCHES).  
2. AN EPOXY MENISCUS MAY EXTEND ABOUT 1mm (.040") DOWN THE LEADS.

## Selection Guide

Color	Part Number HLMP-	Package	Operating Voltage	I <sub>v</sub> mcd		2θ <sub>1/2</sub> [1]	Package Outline
				Min.	Typ.		
High Efficiency Red	1600	T-1 Tinted Diffused	5	2.1	8.0	60°	A
	1601		12				
	3600	T-1 <sup>3/4</sup> Tinted Diffused	5			60°	B
	3601		12				
Yellow	1620	T-1 Tinted Diffused	5	2.2	8.0	60°	A
	1621		12				
	3650	T-1 <sup>3/4</sup> Tinted Diffused	5			60°	B
	3651		12				
High Performance Green	1640	T-1 Tinted Diffused	5	1.6	8.0	60°	A
	1641		12				
	3680	T-1 <sup>3/4</sup> Tinted Diffused	5			60°	B
	3681		12				

**Note:**

1. θ<sub>1/2</sub> is the off-axis angle at which the luminous intensity is 1/2 the axial luminous intensity.

## Absolute Maximum Ratings at T<sub>A</sub> = 25°C

	Red/HER/ Yellow 5 Volt Lamps	Red/HER/ Yellow 12 Volt Lamps	Green 5 Volt Lamps	Green 12 Volt Lamps
DC Forward Voltage (T <sub>A</sub> = 25°C)	7.5 Volts <sup>[2]</sup>	15 Volts <sup>[3]</sup>	7.5 Volts <sup>[2]</sup>	15 Volts <sup>[3]</sup>
Reverse Voltage (I <sub>R</sub> = 100 μA)	5 Volts	5 Volts	5 Volts	5 Volts
Operating Temperature Range	-40°C to 85°C	-40°C to 85°C	-20°C to 85°C	-20°C to 85°C
Storage Temperature Range	-55°C to 100°C	-55°C to 100°C	-55°C to 100°C	-55°C to 100°C
Lead Soldering Temperature	260°C for 5 seconds			

**Notes:**

2. Derate from T<sub>A</sub> = 50°C at 0.071 V/°C, see Figure 3.
3. Derate from T<sub>A</sub> = 50°C at 0.086 V/°C, see Figure 4.



**Electrical/Optical Characteristics at  $T_A = 25^\circ\text{C}$**

Symbol	Description	High Efficiency Red			Yellow			Green			Unit	Test Condition
		Min.	Typ.	Max.	Min.	Typ.	Max.	Min.	Typ.	Max.		
$\lambda_P$	Peak Wavelength		635			583			565		nm	
$\lambda_d$	Dominant Wavelength		626			585			569		nm	Note 4
$\Delta\lambda^{1/2}$	Spectral Line Halfwidth		40			36			28		nm	
$R\theta_{J-PIN}$	Thermal Resistance		290			290			290		$^\circ\text{C/W}$	Junction to Cathode Lead (Note 6)
$R\theta_{J-PIN}$	Thermal Resistance		210			210			210		$^\circ\text{C/W}$	Junction to Cathode Lead (Note 7)
$I_F$	Forward Current 12 V Devices		13	20		13	20		13	20	mA	$V_F = 12\text{ V}$
$I_F$	Forward Current 5 V Devices		10	15		10	15		10	15	mA	$V_F = 5\text{ V}$
$\eta_V$	Luminous Efficacy		145			500			595		lumen/Watt	Note 2
$V_R$	Reverse Breakdown Voltage	5.0			5.0			5.0			V	$I_R = 100\ \mu\text{A}$

**Notes:**

4. The dominant wavelength,  $\lambda_d$ , is derived from the CIE chromaticity diagram and represents the single wavelength which defines the color of the device.
5. Radiant intensity,  $I_e$ , in watts/steradian, may be found from the equation  $I_e = I_v/\eta_V$ , where  $I_v$  is the luminous intensity in candelas and  $\eta_V$  is the luminous efficacy in lumens/Watt.
6. For Figure A package type.
7. For Figure B package type.

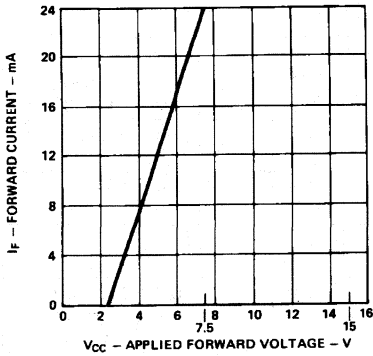

Figure 1. Forward Current vs. Applied Forward Voltage. 5 Volt Devices.

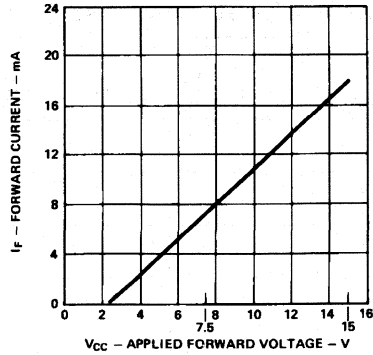

Figure 2. Forward Current vs. Applied Forward Voltage. 12 Volt Devices.

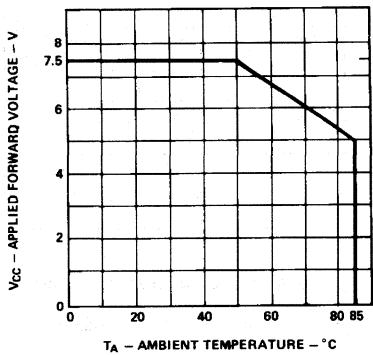

Figure 3. Maximum Allowed Applied Forward Voltage vs. Ambient Temperature  $R\theta_{JA} = 175^{\circ}\text{C}/\text{W}$ . 5 Volt Devices.

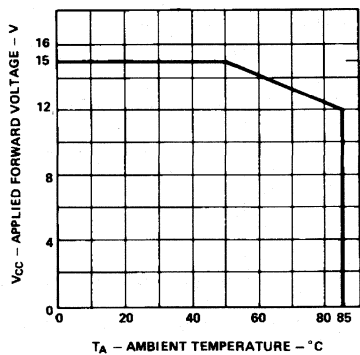

Figure 4. Maximum Allowed Applied Forward Voltage vs. Ambient Temperature  $R\theta_{JA} = 175^{\circ}\text{C}/\text{W}$ . 12 Volt Devices.

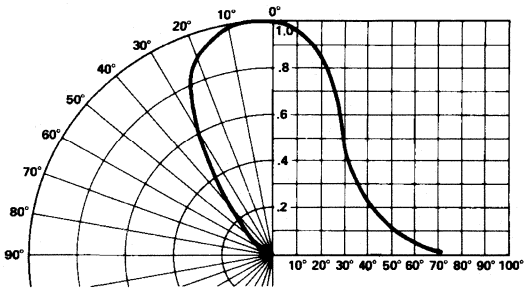

Figure 4. Relative Luminous Intensity vs. Angular Displacement for T-1 Package.

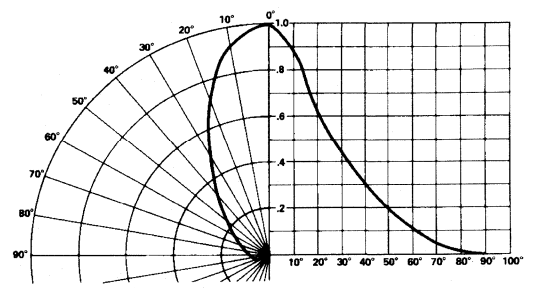

Figure 5. Relative Luminous Intensity vs. Angular Displacement for T-1<sup>1/4</sup> Package.

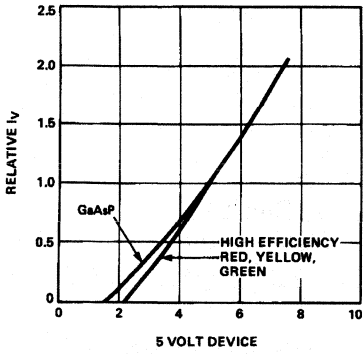

Figure 6. Relative Luminous Intensity vs. Applied Forward Voltage. 5 Volt Devices.

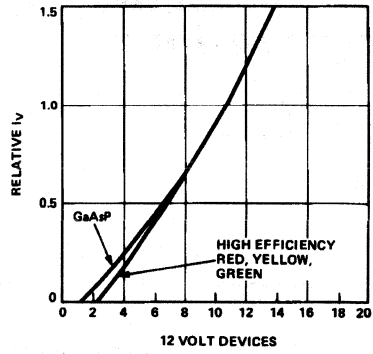

Figure 7. Relative Luminous Intensity vs. Applied Forward Voltage. 12 Volt Devices.

# T-1<sup>3</sup>/<sub>4</sub> (5 mm) Right Angle LED Indicator Options

## Technical Data

**Option 010**  
**Option 100**

### Features

- Ideal for Card Edge Status Indication
- Package Design Allows Flush Seating on a PC Board
- May be Side Stacked on 6.35 mm (0.25") Centers
- LEDs Available in Four Colors, With or Without Integrated Current Limiting Resistor in T-1<sup>3</sup>/<sub>4</sub> Tinted Diffused Packages

- Housing Meets UL9V-0 Flammability Rating
- Additional Catalog Lamps Available as Options

### Description

The T-1<sup>3</sup>/<sub>4</sub> Option 010 and 100 series of Right Angle Indicators are industry standard status indicators that incorporate a T-1<sup>3</sup>/<sub>4</sub> LED lamp in a black plastic right angle mount housing. The indicators are available in

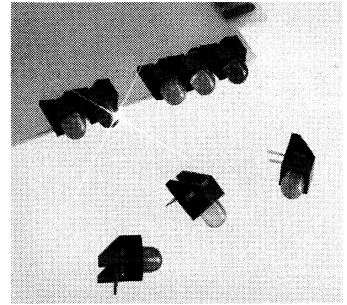

### Package Dimensions

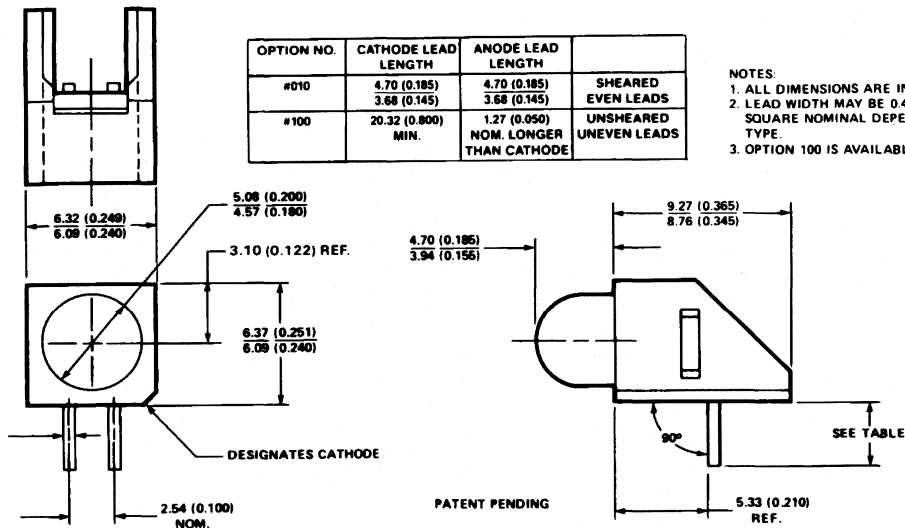

standard Red, High Efficiency Red, Yellow, or High Performance Green with or without an integrated current limiting resistor. These products are designed to be used as back panel diagnostic indicators and card edge logic status indicators.

### **Ordering Information**

To order T-1 $\frac{3}{4}$  high dome lamps with right angle mount housing, select the base part number and

add the option code 010 or 100. For example: HLMP-3750 option 010.

All Hewlett-Packard T-1 $\frac{3}{4}$  high-dome lamps are available in right angle housing. Contact your local Hewlett-Packard Sales Office or authorized components distributor for additional ordering information.

The Plastic right angle housing may be purchased separately as part number HLMP-5029.

### **Absolute Maximum Ratings and Electrical/Optical Characteristics**

The absolute maximum ratings and device characteristics are identical to those of the T-1 $\frac{3}{4}$  LED lamps. For information about these characteristics, see the data sheets of the equivalent T-1 $\frac{3}{4}$  LED lamp.

# T-1<sup>3</sup>/<sub>4</sub> (5 mm) Right Angle Mount Housing

## Technical Data

**HLMP-5029**  
**Option 010**  
**Option 100**

### Features

- Fits Any HP High Dome T-1<sup>3</sup>/<sub>4</sub> LED Lamp
- Snap-In Fit Makes Mounting Simple
- High Contrast Black Plastic
- May be Ordered with Mounted T-1<sup>3</sup>/<sub>4</sub> Lamp as an Option

### Description

The HLMP-5029 is a black plastic right angle housing which mates with Hewlett-Packard high dome T-1<sup>3</sup>/<sub>4</sub> lamps. The leads should be prebent 90° as shown prior to snapping into the right angle housing.

The housing material is high temperature nylon capable of withstanding temperatures up to +150°C.

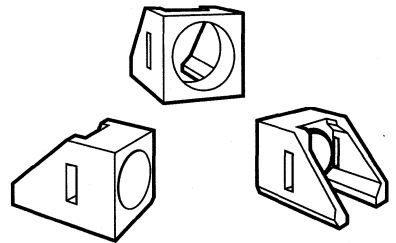

### Physical Dimensions

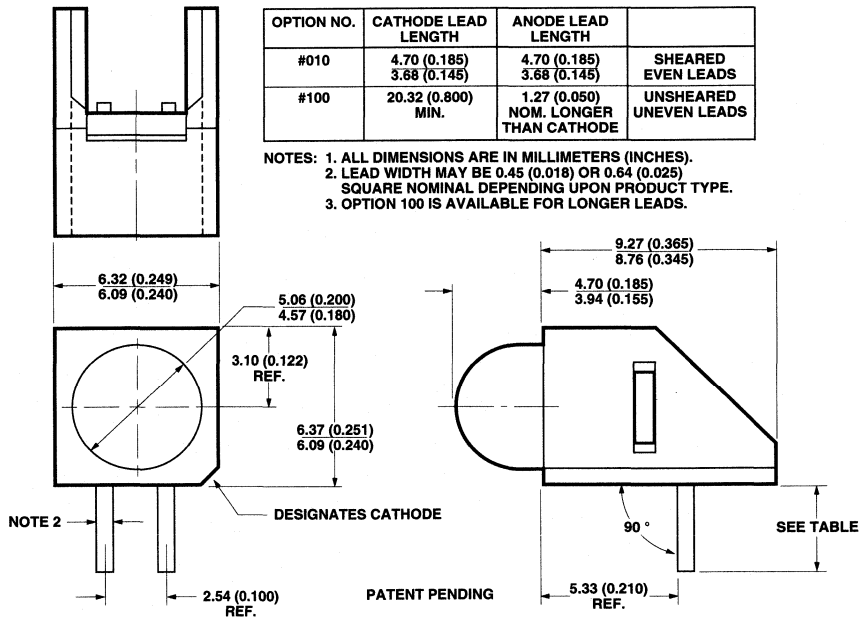

As an option, T-1<sup>3/4</sup> lamps may be ordered pre-mounted into the HLMP-5029 housing with leads bent down 90° and sheared to length, see table. To order, select the lamp base, part number and affix the desired option code. For example, the HLMP-3300 HER lamp may be ordered pre-mounted into the HLMP-5029 housing with leads sheared to an even length. The part number for this option is: **HLMP-3300 Option 010.**

# T-1<sup>3/4</sup> (5 mm) Panel Mount Clip and Retaining Ring

## Technical Data

Option 007 (HLMP-0104)

### Description

The Option 007 (HLMP-0104) is a black plastic mounting clip and retaining ring. It is designed to panel mount Hewlett-Packard Solid State high profile T-1<sup>3/4</sup> size lamps. This clip and ring combination is intended for installation in instrument panels from 1.52 mm (0.060") to 3.18 mm (0.125") thick. For panels greater than 3.18 mm (0.125") counterboring is required to the 3.18 mm (0.125") thickness.

### Mounting Instructions

1. Drill a 6.35/6.53 (0.250/0.257 in.) dia. hole in the panel. Deburr but do not chamfer the edges of the hole.
2. Press the panel clip into the hole from the front of the panel.
3. Press the LED into the clip from the back. Use blunt long nose pliers to push on the LED. Do not use force on the LED leads. A tool such as a nut driver may be used to press on the clip.

**Note:** Clip and retaining ring are also available for T-1 package, from a non-HP source. Please contact Interconsal Association, 2584 Wyandotte Way, Mountain View, CA for additional information. Telephone: (408) 745-0161.

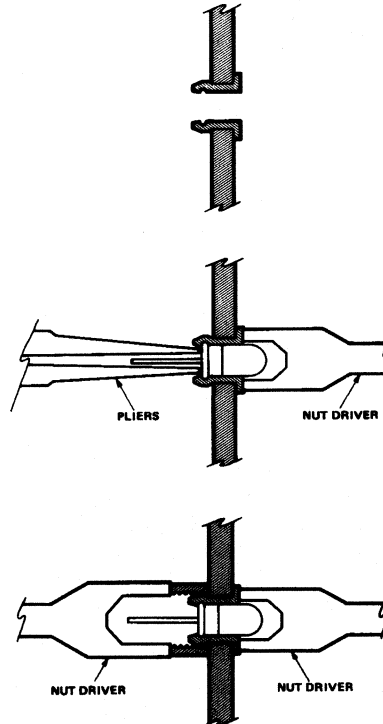
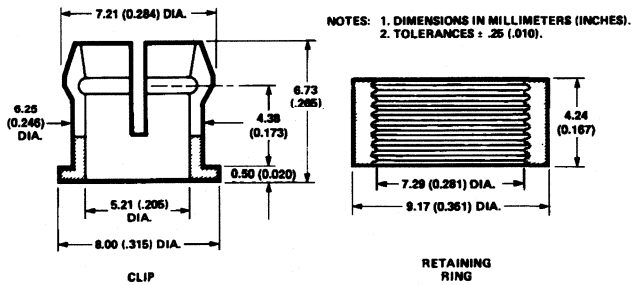



4. Slip a plastic retaining ring onto the back of the clip and press tight using tools such as two nut drivers.

### **Ordering Information**

T-1 $\frac{3}{4}$  High Dome LED Lamps can be purchased to include clip and

ring by adding Option Code 007 to the device catalog part number.

Example: To order the HLMP-3300 including clip and ring, order as follows: HLMP-3300 Option 007.

# T-1 (3 mm) High Performance TS AlGaAs Red LED Lamps

## Technical Data

**HLMP-J100**  
**HLMP-J105**  
**HLMP-J150**  
**HLMP-J155**

### Features

- High Light Output over a Wide Range of Currents (500  $\mu$ A to 50 mA)
- Popular T-1 Package
- Low Forward Voltage
- Low Power Dissipation
- Deep Red Color
- Long Life: Solid State Reliability
- Wide Viewing Angles
- Available on Tape and Reel

### Applications

- Outdoor Message Boards
- Automotive Lighting
- Portable Equipment
- Safety Lighting Equipment
- Medical Equipment
- Changeable Message Signs

### Package Dimensions

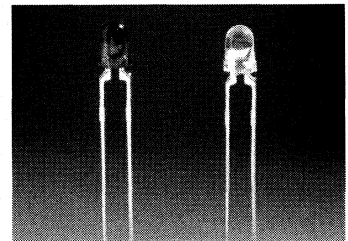
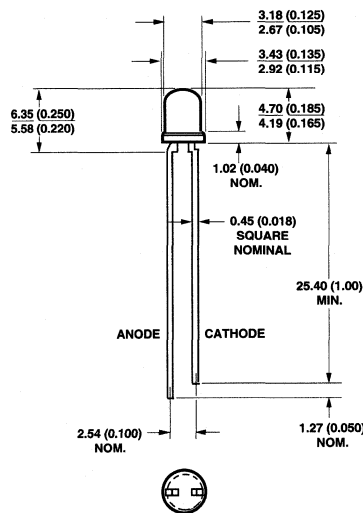

### Description

The T-1 solid state lamps utilize a highly optimized LED material technology, transparent substrate aluminum gallium arsenide (TS AlGaAs). This LED technology has a very high luminous efficiency, capable of producing high light output over a wide range of drive currents (500  $\mu$ A to 50 mA). The color is deep red at a dominant wavelength of 644 nm. TS AlGaAs is a flip-chip LED technology, die attached to the anode lead and wire bonded to the cathode lead.

### Device Selection Guide

Package Description	Viewing Angle $2\theta^{1/2}$	Deep Red $\lambda_d = 644 \text{ nm}$	Typical $I_V$ (mcd) $I_F = 20 \text{ mA}$	Typical $I_V$ (mcd) $I_F = 0.5 \text{ mA}$
T-1 (3 mm), Untinted, Non-diffused, Standard Current	45°	HLMP-J105	340	–
T-1 (3 mm), Untinted, Non-diffused, Low Current	45°	HLMP-J155	–	6
T-1 (3 mm), Tinted, Diffused, Standard Current	55°	HLMP-J100	175	–
T-1 (3 mm), Tinted, Diffused, Low Current	55°	HLMP-J150	–	3

## Absolute Maximum Ratings

Peak Forward Current <sup>[2]</sup> .....	300 mA
Average Forward Current (@ $I_{PEAK} = 300$ mA) <sup>[1,2]</sup> .....	30 mA
DC Forward Current <sup>[3]</sup> .....	50 mA
Power Dissipation .....	100 mW
Reverse Voltage ( $I_R = 100$ $\mu$ A) .....	5 V
Transient Forward Current (10 $\mu$ s Pulse) <sup>[4]</sup> .....	500 mA
Operating Temperature Range .....	-55 to +100°C
Storage Temperature Range .....	-55 to +100°C
LED Junction Temperature .....	110°C
Solder Temperature .....	260°C for 5 seconds
[1.6 mm (0.063 in.) from body]	

### Notes:

1. Maximum  $I_{AVG}$  at  $f = 1$  kHz,  $DF = 10\%$ .
2. Refer to Figure 6 to establish pulsed operating conditions.
3. Derate linearly as shown in Figure 5.
4. The transient peak current is the maximum non-recurring peak current the device can withstand without damaging the LED die and wire bonds. It is not recommended that the device be operated at peak currents above the Absolute Maximum Peak Forward Current.

## Optical Characteristics at $T_A = 25^\circ\text{C}$

Part Number	Luminous Intensity $I_V$ (mcd) @ 20 mA <sup>[1]</sup>		Total Flux $\phi_V$ (mlm) @ 20 mA <sup>[2]</sup> Typ.	Peak Wavelength $\lambda_{PEAK}$ (nm) Typ.	Color, Dominant Wavelength $\lambda_d$ <sup>[3]</sup> (nm) Typ.	Viewing Angle $2\theta^{1/2}$ (Degrees) <sup>[4]</sup> Typ.	Luminous Efficacy $\eta_V$ (lm/w)
	Min.	Typ.					
HLMP-J105	56.4	340	280	654	644	45	85
HLMP-J100	35.2	175		654	644	55	85

## Optical Characteristics at $T_A = 25^\circ\text{C}$

Part Number (Low Current)	Luminous Intensity $I_V$ (mcd) @ 0.5 mA <sup>[1]</sup>		Total Flux $\phi_V$ (mlm) @ 0.5 mA <sup>[2]</sup> Typ.	Peak Wavelength $\lambda_{PEAK}$ (nm) Typ.	Color, ZDominant Wavelength $\lambda_d$ <sup>[3]</sup> (nm) Typ.	Viewing Angle $2\theta^{1/2}$ (Degrees) <sup>[4]</sup> Typ.	Luminous Efficacy $\eta_V$ (lm/w)
	Min.	Typ.					
HLMP-J155	2.1	6.0	37.2	654	644	45	85
HLMP-J150	1.3	3.0		654	644	55	85

### Notes:

1. The luminous intensity,  $I_V$ , is measured at the mechanical axis of the lamp package. The actual peak of the spatial radiation pattern may not be aligned with this axis.
2.  $\phi_V$  is total luminous flux output as measured with an integrating sphere.
3. The dominant wavelength,  $\lambda_d$ , is derived from the CIE Chromaticity Diagram and represents the color of the device.
4.  $\theta^{1/2}$  is the off-axis angle where the luminous intensity is 1/2 the peak intensity.

### Electrical Characteristics at $T_A = 25^\circ\text{C}$

Part Number	Forward Voltage $V_F$ (Volts) @ $I_F = 20\text{ mA}$		Reverse Breakdown $V_R$ (Volts) @ $I_R = 100\ \mu\text{A}$		Capacitance $C$ (pF) $V_F = 0$ , $f = 1\text{ MHz}$ Typ.	Thermal Resistance $R\theta_{J-PIN}$ ( $^\circ\text{C/W}$ )	Speed of Response $\tau_s$ (ns) Time Constant $e^{-t/\tau_s}$ Typ.
	Typ.	Max.	Min.	Typ.			
HLMP-J105	1.9	2.4	5	20	20	290	45
HLMP-J100	1.9	2.4	5	20	20	290	45

### Electrical Characteristics at $T_A = 25^\circ\text{C}$

Part Number (Low Current)	Forward Voltage $V_F$ (Volts) @ $I_F = 0.5\text{ mA}$		Reverse Breakdown $V_R$ (Volts) @ $I_R = 100\ \mu\text{A}$		Capacitance $C$ (pF) $V_F = 0$ , $f = 1\text{ MHz}$ Typ.	Thermal Resistance $R\theta_{J-PIN}$ ( $^\circ\text{C/W}$ )	Speed of Response $\tau_s$ (ns) Time Constant $e^{-t/\tau_s}$ Typ.
	Typ.	Max.	Min.	Typ.			
HLMP-J155	1.6	1.9	5	20	20	290	45
HLMP-J150	1.6	1.9	5	20	20	290	45

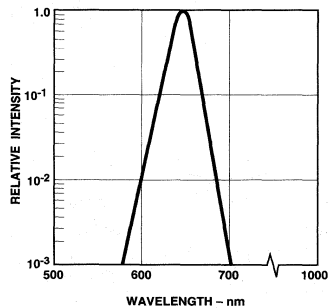

Figure 1. Relative Intensity vs. Wavelength.

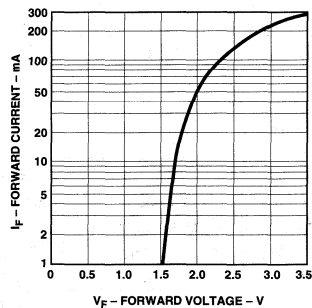

Figure 2. Forward Current vs. Forward Voltage.

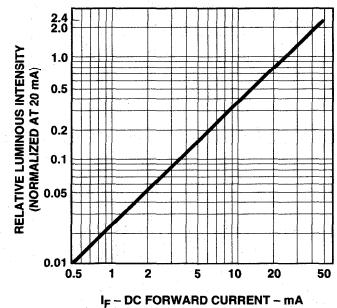

Figure 3. Relative Luminous Intensity vs. DC Forward Current.

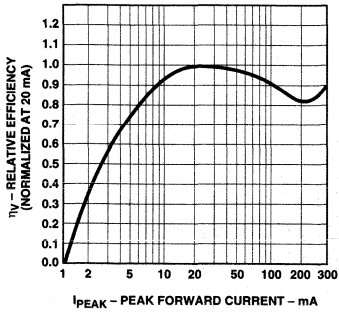

Figure 4. Relative Efficiency vs. Peak Forward Current.

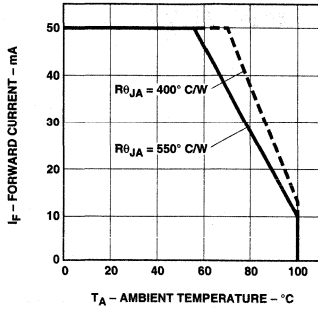

Figure 5. Maximum Forward DC Current vs. Ambient Temperature. Derating Based on  $T_{JMAX} = 110^{\circ}C$ .

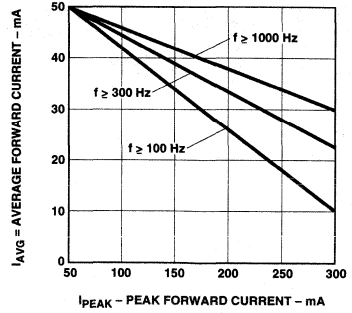

Figure 6. Maximum Average Current vs. Peak Forward Current.

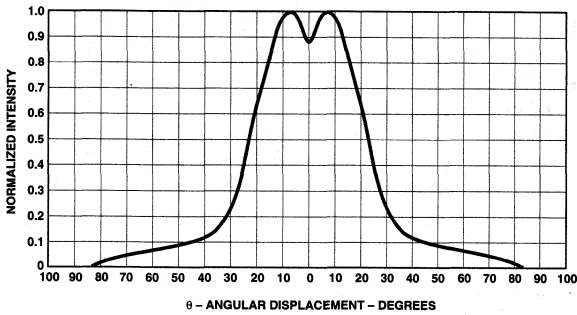

Figure 7. Normalized Luminous Intensity vs. Angular Displacement. HLMP-J105/J155.

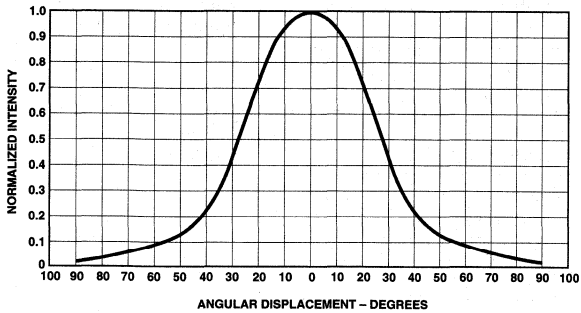

Figure 8. Normalized Luminous Intensity vs. Angular Displacement. HLMP-J100/J150.

# T-1 (3 mm) High Intensity LED Lamps

## Technical Data

**HLMP-132X Series**  
**HLMP-142X Series**  
**HLMP-152X Series**

### Features

- High Intensity
- Choice of 3 Bright Colors  
High Efficiency Red  
Yellow  
High Performance Green
- Popular T-1 Diameter Package
- Selected Minimum Intensities
- Narrow Viewing Angle

- General Purpose Leads
- Reliable and Rugged
- Available on Tape and Reel

### Description

This family of T-1 lamps is specially designed for applications requiring higher on-axis intensity than is achievable with a standard lamp. The light generated is focused to a narrow beam to achieve this effect.

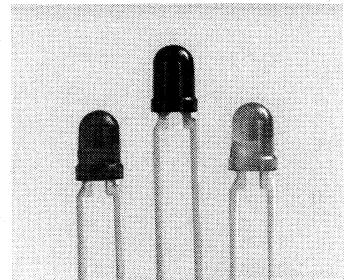

### Package Dimensions

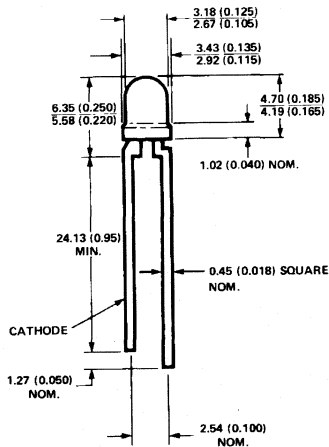

NOTES:  
 1. ALL DIMENSIONS ARE IN MILLIMETRES (INCHES).  
 2. AN EPOXY MENISCUS MAY EXTEND ABOUT 1mm (0.040") DOWN THE LEADS.

### Selection Guide

Part Number HLMP-	Description	Minimum Intensity (mcd) at 10 mA	Color (Material)
1320	Untinted Nondiffused	8.6	High Efficiency Red (GaAsP on GaP)
1321	Tinted Nondiffused	8.6	
1420	Untinted Nondiffused	9.2	Yellow (GaAsP on GaP)
1421	Tinted Nondiffused	9.2	
1520	Untinted Nondiffused	6.7	Green (GaP)
1521	Tinted Nondiffused	6.7	

**Absolute Maximum Ratings at  $T_A = 25^\circ\text{C}$** 

Parameter	Red	Yellow	Green	Units
Peak Forward Current	90	60	90	mA
Average Forward Current <sup>[1]</sup>	25	20	25	mA
DC Current <sup>[2]</sup>	30	20	30	mA
Power Dissipation <sup>[3]</sup>	135	85	135	mW
Reverse Voltage ( $I_R = 100 \mu\text{A}$ )	5	5	5	V
Transient Forward Current <sup>[4]</sup> (10 $\mu\text{sec}$ Pulse)	500	500	500	mA
LED Junction Temperature	110	110	110	$^\circ\text{C}$
Operating Temperature Range	-55 to +100	-55 to +100	-20 to +100	$^\circ\text{C}$
Storage Temperature Range			-55 to +100	
Lead Soldering Temperature [1.6 mm (0.063 in.) from body]	260 $^\circ\text{C}$ for 5 seconds			

**Notes:**

- See Figure 5 (Red), 10 (Yellow), or 15 (Green) to establish pulsed operating conditions.
- For Red and Green series derate linearly from 50 $^\circ\text{C}$  at 0.5 mA/ $^\circ\text{C}$ . For Yellow series derate linearly from 50 $^\circ\text{C}$  at 0.2 mA/ $^\circ\text{C}$ .
- For Red and Green series derate power linearly from 25 $^\circ\text{C}$  at 1.8 mW/ $^\circ\text{C}$ . For Yellow series derate power linearly from 50 $^\circ\text{C}$  at 1.6 mW/ $^\circ\text{C}$ .
- The transient peak current is the maximum non-recurring peak current that can be applied to the device without damaging the LED die and wirebond. It is not recommended that the device be operated at peak currents beyond the peak forward current listed in the Absolute Maximum Ratings.

### Electrical Characteristics at $T_A = 25^\circ\text{C}$

Symbol	Description	Device HLMP-	Min.	Typ.	Max.	Units	Test Conditions
$I_V$	Luminous Intensity	1320	8.6	30		mcd	$I_F = 10\text{ mA}$ (Figure 3)
		1321	8.6	30			
		1420	9.2	15		mcd	$I_F = 10\text{ mA}$ (Figure 8)
1421	9.2	15					
		1520	6.7	22		mcd	$I_F = 10\text{ mA}$ (Figure 3)
		1521	6.7	22			
$2\theta^{1/2}$	Including Angle Between Half Luminous Intensity Points	All		45		Deg.	$I_F = 10\text{ mA}$ See Note 1 (Figures 6, 11, 16, 21)
$\lambda_{\text{PEAK}}$	Peak Wavelength	132X 142X 152X		635 583 565		nm	Measurement at Peak (Figure 1)
$\Delta\lambda_{1/2}$	Spectral Line Halfwidth	132X 142X 152X		40 36 28		nm	
$\lambda_d$	Dominant Wavelength	132X 142X 152X		626 585 569		nm	See Note 2 (Figure 1)
$\tau_s$	Speed of Response	132X 142X 152X		90 90 500		ns	
C	Capacitance	132X 142X 152X		11 15 18		pF	$V_F = 0$ ; $f = 1\text{ MHz}$
$R\theta_{J-PIN}$	Thermal Resistance	All		290		$^\circ\text{C/W}$	Junction to Cathode Lead
$V_F$	Forward Voltage	132X 142X 152X		1.9 2.0 2.1	2.4 2.4 2.7	V	$I_F = 10\text{ mA}$
$V_R$	Reverse Breakdown Voltage	All	5.0			V	$I_R = 100\ \mu\text{A}$
$\eta_V$	Luminous Efficacy	132X 142X 152X		145 500 595		$\frac{\text{lumens}}{\text{Watt}}$	See Note 3

**Notes:**

- $\theta^{1/2}$  is the off-axis angle at which the luminous intensity is half the axial luminous intensity.
- The dominant wavelength,  $\lambda_d$ , is derived from the CIE chromaticity diagram and represents the single wavelength which defines the color of the device.
- Radiant intensity,  $I_e$ , in watts/steradian, may be found from the equation  $I_e = I_v/\eta_v$ , where  $I_v$  is the luminous intensity in candelas and  $\eta_v$  is the luminous efficacy in lumens/watt.



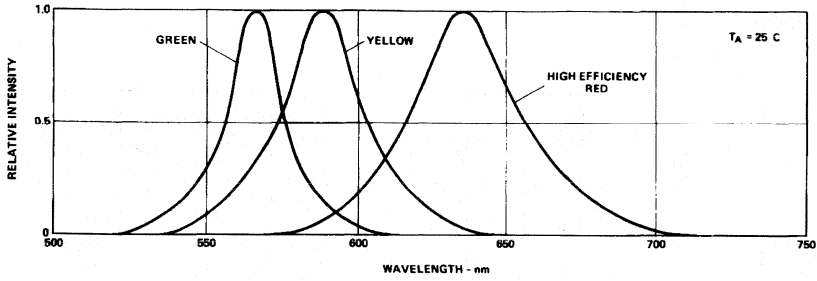

Figure 1. Relative Intensity vs. Wavelength.

### T-1 High Efficiency Red Non-Diffused

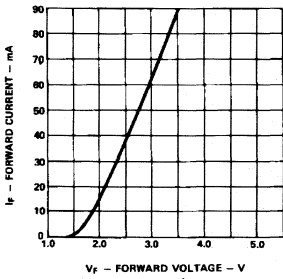

Figure 2. Forward Current vs. Forward Voltage Characteristics.

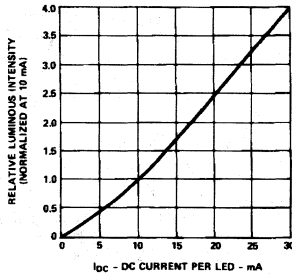

Figure 3. Relative Luminous Intensity vs. DC Forward Current.

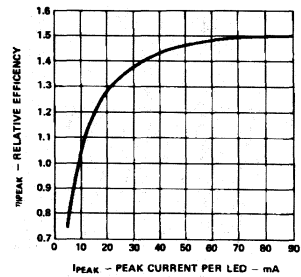

Figure 4. Relative Efficiency (Luminous Intensity per Unit Current) vs. Peak LED Current.

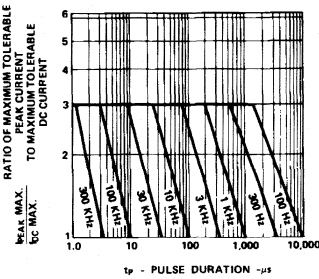

Figure 5. Maximum Tolerable Peak Current vs. Pulse Duration. ( $I_{DC}$  MAX as per MAX Ratings).

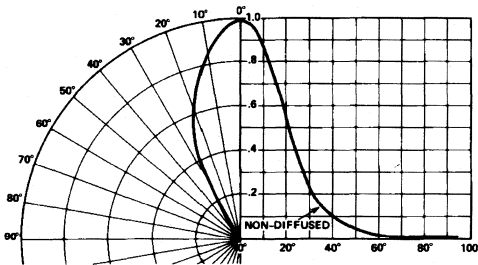

Figure 6. Relative Luminous Intensity vs. Angular Displacement.

# T-1 Yellow Non-Diffused

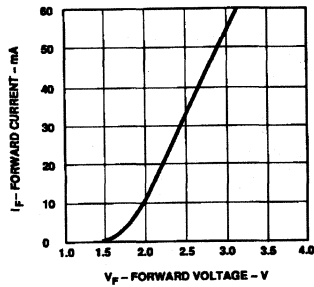

Figure 7. Forward Current vs. Forward Voltage Characteristics.

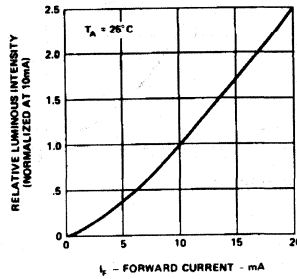

Figure 8. Relative Luminous Intensity vs. Forward Current.

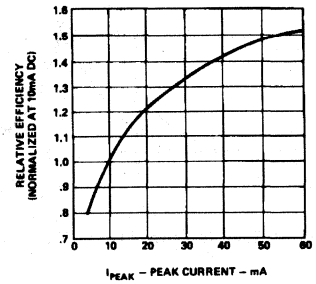

Figure 9. Relative Efficiency (Luminous Intensity per Unit Current) vs. Peak Current.

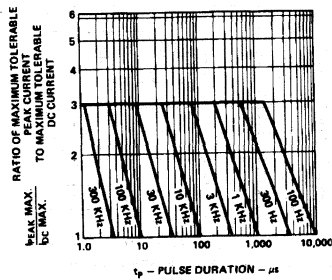

Figure 10. Maximum Tolerable Peak Current vs. Pulse Duration. ( $I_{DCMAX}$  as per MAX Ratings).

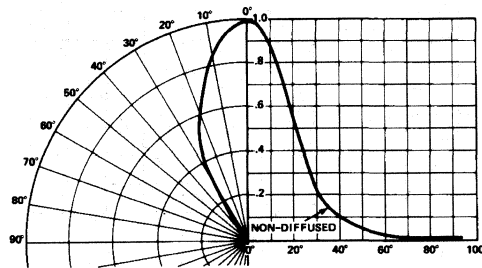

Figure 11. Relative Luminous Intensity vs. Angular Displacement.

## T-1 Green Non-Diffused

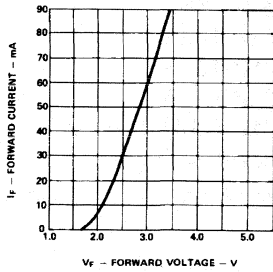

Figure 12. Forward Current vs. Forward Voltage Characteristics.

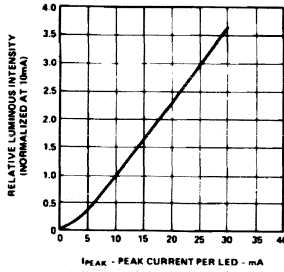

Figure 13. Relative Luminous Intensity vs. Forward Current.

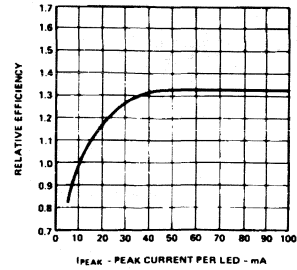

Figure 14. Relative Efficiency (Luminous Intensity per Unit Current) vs. Peak LED Current.

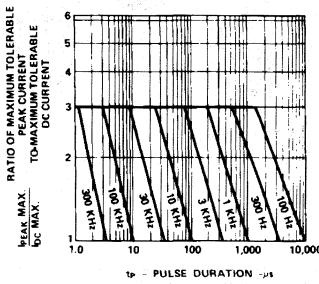

Figure 15. Maximum Tolerable Peak Current vs. Pulse Duration. ( $I_{DCMAX}$  as per MAX Ratings).

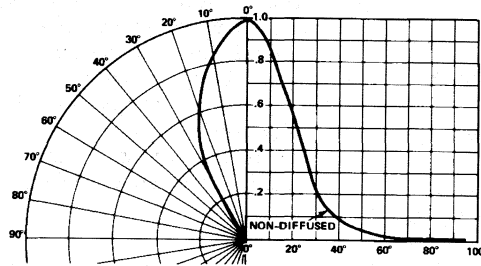

Figure 16. Relative Luminous Intensity vs. Angular Displacement.

# T-1 (3 mm) Diffused LED Lamps

## Technical Data

**HLMP-130X Series**  
**HLMP-1385**  
**HLMP-140X Series**  
**HLMP-1485**  
**HLMP-1503**  
**HLMP-1523**  
**HLMP-1585**  
**HLMP-K40X Series**  
**HLMP-K600**

### Features

- **High Intensity**
- **Choice of 4 Bright Colors**  
High Efficiency Red  
Orange  
Yellow  
High Performance Green
- **Popular T-1 Diameter Package**
- **Selected Minimum Intensities**
- **Wide Viewing Angle**
- **General Purpose Leads**

- **Reliable and Rugged**
- **Available on Tape and Reel**

### Description

This family of T-1 lamps is widely used in general purpose indicator applications. Diffusants, tints, and optical design are balanced to yield superior light output and wide viewing angles. Several intensity choices are available in each color for increased design flexibility.

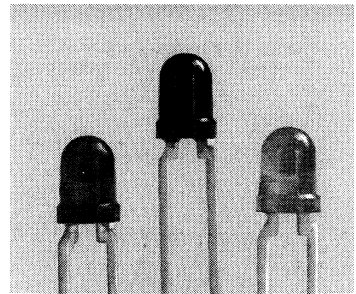

### Package Dimensions

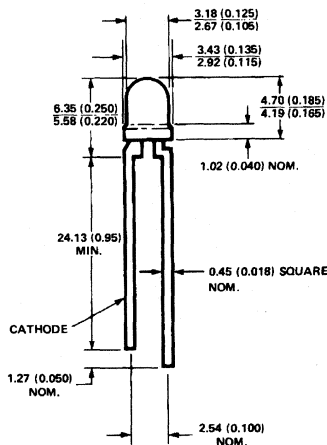

NOTES:  
 1. ALL DIMENSIONS ARE IN MILLIMETRES (INCHES).  
 2. AN EPOXY MENISCUS MAY EXTEND ABOUT 1mm (0.040") DOWN THE LEADS.

Part Number HLMP-	Application	Minimum Intensity (mcd) at 10 mA	Color (Material)
1300	General Purpose	1.3	High Efficiency Red (GaAsP on GaP)
1301	General Purpose	2.1	
1302	High Ambient	3.4	
1385	Premium Lamp	8.6	Orange (GaAsP on GaP)
K400	General Purpose	1.3	
K401	High Ambient	2.1	
K402	Premium Lamp	3.4	Yellow (GaAsP on GaP)
1400	General Purpose	1.4	
1401	General Purpose	2.2	
1402	High Ambient	3.6	Green (GaP)
1485	Premium Lamp	5.7	
1503	General Purpose	1.0	
1523	High Ambient	2.6	Emerald Green (GaP)
1585	Premium Lamp	4.2	
K600 <sup>(1)</sup>	General Purpose	1.0	

### Note:

1. Please refer to Application Note 1061 for information comparing standard green and emerald green light output degradation.

**Absolute Maximum Ratings at  $T_A = 25^\circ\text{C}$** 

Parameter	HER/Orange	Yellow	Green	Units
Peak Forward Current	90	60	90	mA
Average Forward Current <sup>[1]</sup>	25	20	25	mA
DC Current <sup>[2]</sup>	30	20	30	mA
Reverse Voltage ( $I_R = 100 \mu\text{A}$ )	5	5	5	V
Transient Forward Current <sup>[4]</sup> (10 $\mu\text{sec}$ Pulse)	500	500	500	mA
LED Junction Temperature	110	110	110	$^\circ\text{C}$
Operating Temperature Range	-55 to +100	-55 to +100	-20 to +100	$^\circ\text{C}$
Storage Temperature Range			-55 to +100	
Lead Soldering Temperature [1.6 mm (0.063 in.) from body]	260 $^\circ\text{C}$ for 5 seconds			

**Notes:**

- See Figure 5 (HER/Orange), 10 (Yellow), or 15 (Green/Emerald Green) to establish pulsed operating conditions.
- For Red, Orange, and Green series derate linearly from 50 $^\circ\text{C}$  at 0.5 mA/ $^\circ\text{C}$ . For Yellow series derate linearly from 50 $^\circ\text{C}$  at 0.2 mA/ $^\circ\text{C}$ .
- For Red, Orange, and Green series derate power linearly from 25 $^\circ\text{C}$  at 1.8 mW/ $^\circ\text{C}$ . For Yellow series derate power linearly from 50 $^\circ\text{C}$  at 1.6 mW/ $^\circ\text{C}$ .
- The transient peak current is the maximum non-recurring peak current that can be applied to the device without damaging the LED die and wirebond. It is not recommended that the device be operated at peak currents beyond the peak forward current listed in the Absolute Maximum Ratings.

**Electrical Characteristics at  $T_A = 25^\circ\text{C}$** 

Symbol	Description	Device HLMP-	Min.	Typ.	Max.	Units	Test Conditions	
$I_V$	Luminous Intensity	High Efficiency Red				mcd	$I_F = 10 \text{ mA}$	
		1300	1.3	5.0				
		1301	2.1	5.5				
		1302	3.4	7.0				
		1385	8.6	11.0				
		Orange						
		K400	1.3	5.0				
		K401	2.1	5.5				
		K402	3.4	7.0				
		Yellow						
		1400	1.4	5.0				
		1401	2.2	6.0				
		1402	3.6	7.0				
		1485	5.7	10.0				
		Green						
1503	1.0	5.0						
1523	2.6	7.0						
1585	4.2	8.5						
Emerald Green								
K600	1.0	4.5						

### Electrical Characteristics at $T_A = 25^\circ\text{C}$ (cont.)

Symbol	Description	Device HLMP-	Min.	Typ.	Max.	Units	Test Conditions
$2\theta_{1/2}$	Included Angle Between Half Luminous Intensity Points	All		60		Deg.	$I_F = 10\text{ mA}$ See Note 1
$\lambda_{\text{PEAK}}$	Peak Wavelength	High Efficiency Red Orange Yellow Green Emerald Green		635 600 583 565 558		nm	Measurement at Peak
$\lambda_d$	Dominant Wavelength	High Efficiency Red Orange Yellow Green Emerald Green		626 602 585 569 560		nm	See Note 2
$\Delta\lambda_{1/2}$	Spectral Line Halfwidth	High Efficiency Red Yellow Green Emerald Green		40 36 28 24		nm	
$\tau_s$	Speed of Response	High Efficiency Red Orange Yellow Green Emerald Green		90 280 90 500 3100		ns	
C	Capacitance	High Efficiency Red Orange Yellow Green Emerald Green		11 4 15 18 35		pF	$V_F = 0;$ $f = 1\text{ MHz}$
$R\theta_{\text{J-PIN}}$	Thermal Resistance	All		290		$^\circ\text{C/W}$	Junction to Cathode Lead
$V_F$	Forward Voltage	HER/Orange Yellow Green Emerald Green	1.5 1.5 1.5	1.9 2.0 2.1 2.1	2.4 2.4 2.7 2.7	V	$I_F = 10\text{ mA}$
$V_R$	Reverse Breakdown Voltage	All	5.0			V	$I_R = 100\ \mu\text{A}$
$\eta_V$	Luminous Efficacy	High Efficiency Red Orange Yellow Green Emerald Green		145 380 500 595 655		$\frac{\text{lumens}}{\text{Watt}}$	See Note 3

**Notes:**

- $\theta_{1/2}$  is the off-axis angle at which the luminous intensity is half the axial luminous intensity.
- The dominant wavelength,  $\lambda_d$ , is derived from the CIE chromaticity diagram and represents the single wavelength which defines the color of the device.
- Radiant intensity,  $I_e$ , in watts/steradian, may be found from the equation  $I_e = I_v/\eta_v$ , where  $I_v$  is the luminous intensity in candelas and  $\eta_v$  is the luminous efficacy in lumens/watt.

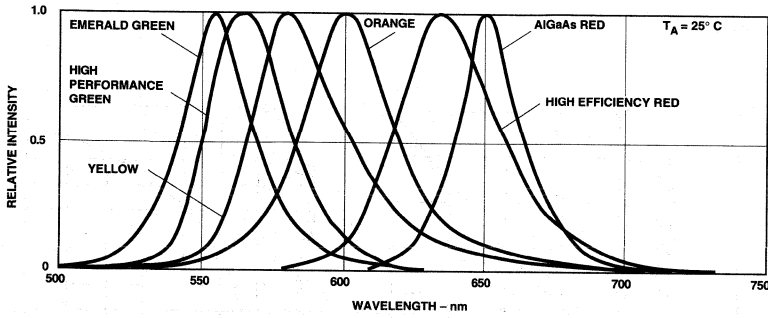

Figure 1. Relative Intensity vs. Wavelength.

### T-1 High Efficiency Red, Orange Diffused Lamps

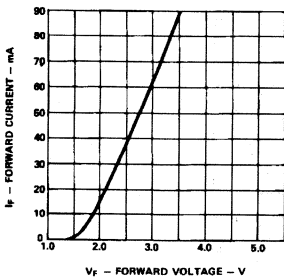

Figure 2. Forward Current vs. Forward Voltage Characteristics.

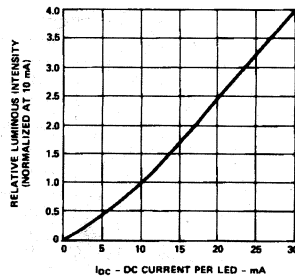

Figure 3. Relative Luminous Intensity vs. DC Forward Current.

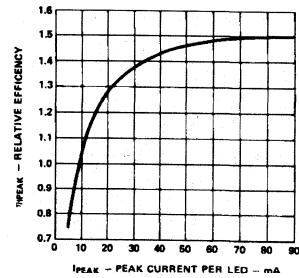

Figure 4. Relative Efficiency (Luminous Intensity per Unit Current) vs. Peak LED Current.

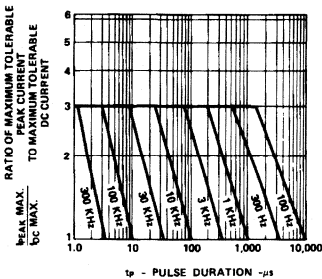

Figure 5. Maximum Tolerable Peak Current vs. Pulse Duration. ( $I_{DC\text{ MAX}}$  as per MAX Ratings).

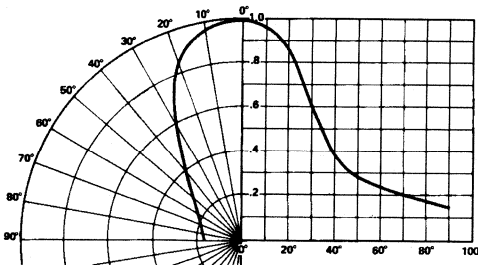

Figure 6. Relative Luminous Intensity vs. Angular Displacement.

## T-1 Yellow Diffused Lamps

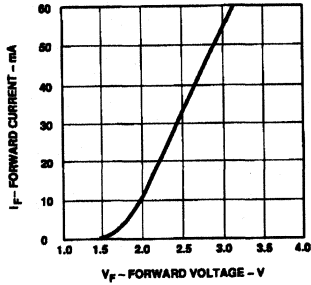

Figure 7. Forward Current vs. Forward Voltage Characteristics.

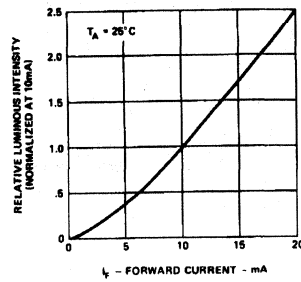

Figure 8. Relative Luminous Intensity vs. Forward Current.

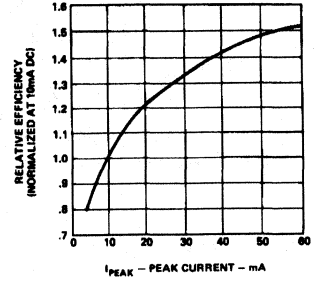

Figure 9. Relative Efficiency (Luminous Intensity per Unit Current) vs. Peak Current.

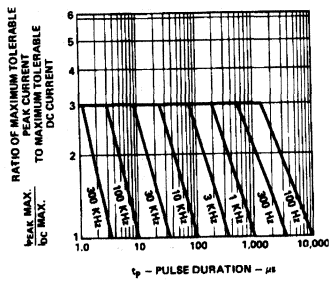

Figure 10. Maximum Tolerable Peak Current vs. Pulse Duration. ( $I_{DC}$  MAX as per MAX Ratings).

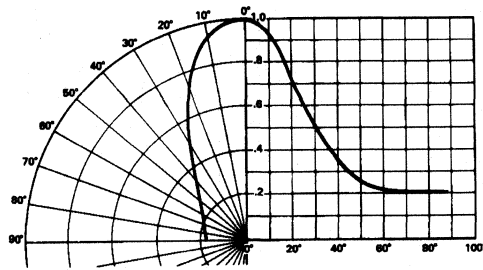

Figure 11. Relative Luminous Intensity vs. Angular Displacement.



## T-1 Green/Emerald Green Diffused Lamps

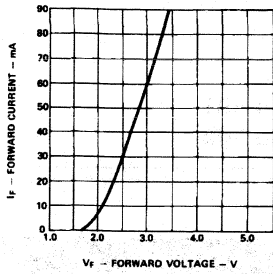

Figure 12. Forward Current vs. Forward Voltage Characteristics.

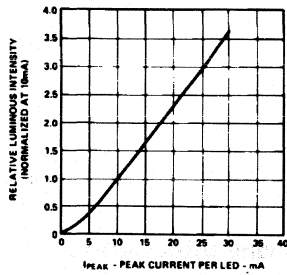

Figure 13. Relative Luminous Intensity vs. Forward Current.

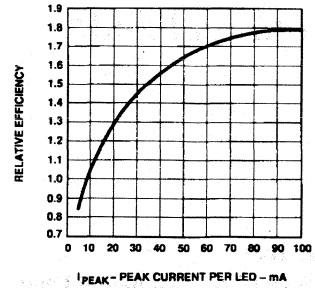

Figure 14. Relative Efficiency (Luminous Intensity per Unit Current) vs. Peak LED Current.

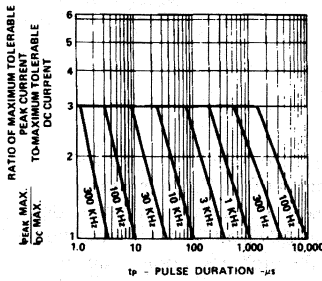

Figure 15. Maximum Tolerable Peak Current vs. Pulse Duration. ( $I_{DC}$  MAX as per MAX Ratings).

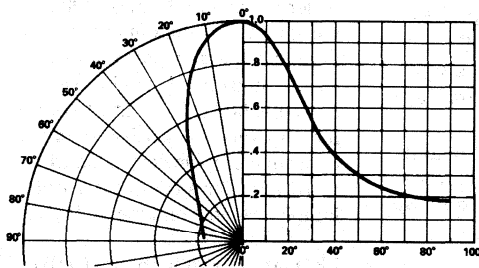

Figure 16. Relative Luminous Intensity vs. Angular Displacement.

# Tape and Reel Options for T-1<sup>3/4</sup> (5 mm), T-1 (3 mm), LED Lamps

## Technical Data

### Features

- **Compatible with Radial Lead Automatic Insertion Equipment**
- **Meets Dimensional Specifications of IEC Publication 286 and ANSI/EIA Standard RS-468 for Tape and Reel**
- **Reel Packaging Simplifies Handling and Testing**
- **T-1 and T-1<sup>3/4</sup> LED Lamps Available Packaged on Tape and Reel**
- **5 mm (0.197 inch) Formed Lead and 2.54 mm (0.100 inch) Straight Lead Spacing Available**

### Description

T-1 and T-1<sup>3/4</sup> LED lamps are available on tape and reel as specified by the IEC Publication 286 and ANSI/EIA Standard RS-468. The Option 001 lamp devices have formed leads with 5 mm (0.197 inch) spacing for automatic insertion into PC boards by radial lead insertion equipment. The Option 002 lamp devices have straight leads with 2.54 mm (0.100 inch) spacing, packaged on tape and reel for ease of handling. T-1 lamps are packaged 1800/reel. T-1<sup>3/4</sup> lamps are packaged 1300/reel.

### Ordering Information

To order LED lamps packaged on tape and reel, include the appropriate option code along with the device catalog part number. Example: to order the HLMP-3300 on tape and reel with formed leads (5 mm lead spacing) order as follows: HLMP-3300 Option 001. Minimum order quantities vary by part number. Orders must be placed in reel increments. Please contact your local Hewlett-Packard sales office or franchised Hewlett-Packard distributor for a complete list of lamps available on tape and reel.

LED lamps with 0.46 mm (0.018 inch) square leads with 5 mm (0.197 inch) lead spacing are recommended for use with automatic insertion equipment. Caution: Hewlett-Packard does

### Device Selection Guide

Option	Description
001	Tape and reel, 5 mm (0.197 inch) formed leads.
002	Tape and reel, 2.54 mm (0.100 inch) straight leads.

Package	Quantity/Reel	Order Increments
T-1	1800	1800
T-1 <sup>3/4</sup>	1300	1300

### Option 001 Option 002

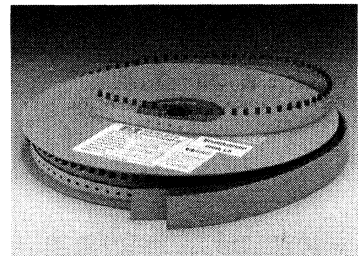

not recommend T-1 package, option 002 LEDs for auto-insertion. The force exerted on the LED lead frame during the cut and clinch operation of auto-insertion may result in cracking of the lamp epoxy dome which results in catastrophic failure. It is suggested that insertion machine compatibility be confirmed.

### Absolute Maximum Ratings and Electrical/Optical Characteristics

The absolute maximum ratings, mechanical dimension tolerances and electrical/optical characteristics for lamps packaged on tape and reel are identical to the basic catalog device. Refer to the basic data sheet for the specified values.

**Notes:**

1. Minimum leader length at either end of tape is 3 blank part spaces.
2. Silver saver paper is used as the interlayer for silver plated lead devices.
3. The maximum number of consecutive missing lamps is 3.
4. In accordance with EIA and IEC specs, the anode lead leaves the reel first.
5. Drawings apply to devices with 0.46 mm (0.018 inch) square leads only. Contact Hewlett-Packard Sales Office for dimensions of 0.635 mm (0.025 inch) square lead devices.

### Tape and Reel LED Configurations

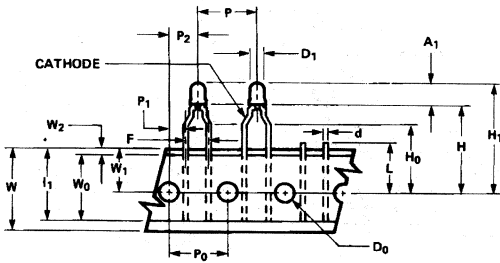

Figure 1. T-1 High Profile Lamps, Option 001.

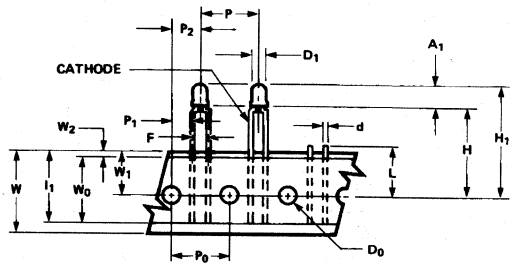

Figure 2. T-1 High Profile Lamps, Option 002.

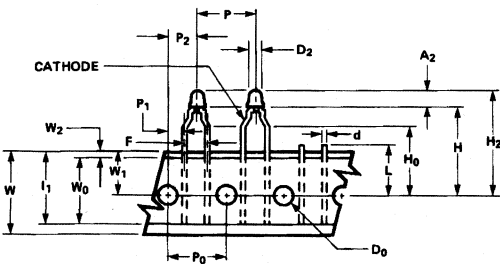

Figure 3. T-1 Low Profile Lamps, Option 001.

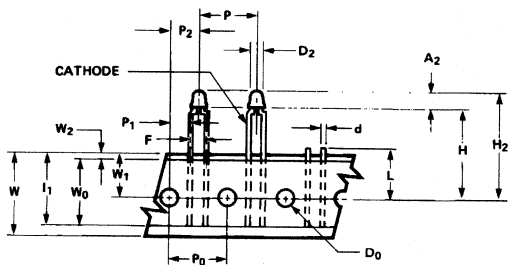

Figure 4. T-1 Low Profile Lamps, Option 002.

## Tape and Reel LED Configurations (cont.)

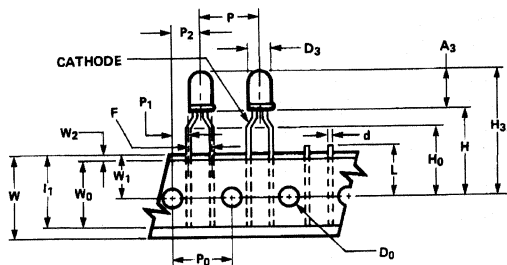

Figure 5. T-1<sup>3/4</sup> High Profile Lamps, Option 001.

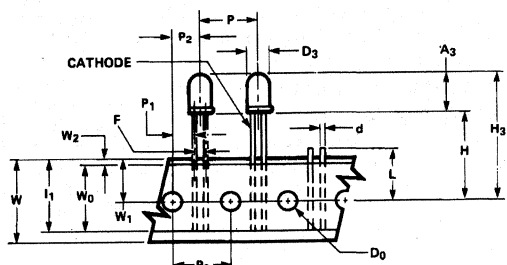

Figure 6. T-1<sup>3/4</sup> High Profile Lamps, Option 002.

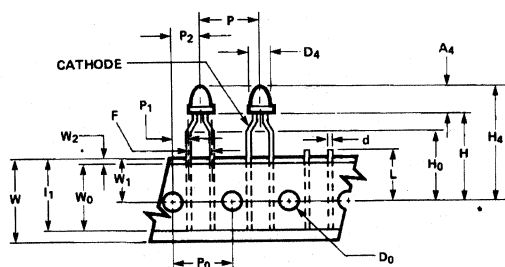

Figure 7. T-1<sup>3/4</sup> Low Profile Lamps, Option 001.

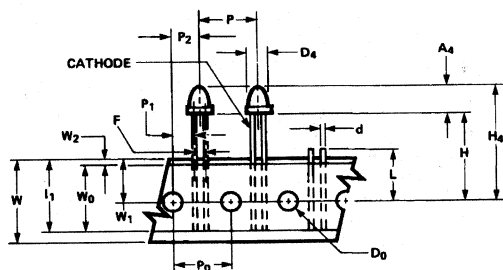









Figure 8. T-1<sup>3/4</sup> Low Profile Lamps, Option 002.

### Dimensional Specifications for Tape and Reel

Item	Option 001	002	Symbol	Specification	Notes
<b>T1 High Profile</b>					
Body Height			A1	<u>4.70 (0.185)</u> 4.19 (0.165)	
Body Diameter			D1	<u>3.18 (0.125)</u> 2.67 (0.105)	
Component Height			H1	25.7 (1.012) Max.	
<b>T1 Low Profile</b>					
Body Height			A2	<u>3.73 (0.147)</u> 3.23 (0.127)	
Body Diameter			D2	<u>3.05 (0.120)</u> 2.79 (0.110)	
Component Height			H2	24.7 (0.974) Max.	
<b>T1<sup>3/4</sup> High Profile</b>					
Body Height			A3	<u>9.19 (0.362)</u> 8.43 (0.332)	
Body Diameter			D3	<u>5.08 (0.200)</u> 4.32 (0.170)	
Component Height			H3	30.2 (1.189) Max.	
<b>T1<sup>3/4</sup> Low Profile</b>					
Body Height			A4	<u>6.35 (0.250)</u> 5.33 (0.210)	
Body Diameter			D4	<u>5.08 (0.200)</u> 4.32 (0.170)	
Component Height			H4	27.4 (1.079) Max.	
Lead Wire Thickness			d	0.45 (0.018)	Square Leads
Pitch of Component			P	<u>13.7 (0.539)</u> 11.7 (0.461)	
Feed Hole Pitch			P <sub>0</sub>	<u>12.9 (0.508)</u> 12.5 (0.492)	Cumulative error: 1.0 mm/20 pitches
Feed Hole Center to Lead Center			P1	<u>4.55 (0.179)</u> 3.15 (0.124)	Measure at crimp bottom 5.78/3.68 (0.227/0.1448) for straight leads
Hole Center to Component Center			P2	<u>7.35 (0.289)</u> 5.35 (0.211)	
Lead to Lead Distance			F	<u>5.40 (0.213)</u> 4.90 (0.193)	2.54 (0.100) nominal for straight leads
Component Alignment, Front-rear			Δh	0 ± 1.0 (0.039)	Figure 9
Tape Width			W	<u>18.5 (0.728)</u> 17.5 (0.689)	
Hold Down Tape Width			W <sub>0</sub>	<u>15.3 (0.602)</u> 12.0 (0.472)	
Hole Position			W1	<u>9.75 (0.384)</u> 8.50 (0.335)	

### Dimensional Specifications for Tape and Reel (cont.)

Item	Option 001	002	Symbol	Specification	Notes
Hold Down Tape Position			W2	2.54 (0.100) Max.	
Height of Component from Hole Center			H	$\frac{21.0 (0.827)}{20.0 (0.787)}$	
Lead Clinch Height			H <sub>O</sub>	$\frac{16.5 (0.650)}{15.5 (0.610)}$	
Feed Hole Diameter			D <sub>O</sub>	$\frac{4.20 (0.165)}{3.80 (0.150)}$	
Total Tape Thickness			t	$\frac{0.90 (0.035)}{0.50 (0.020)}$	Paper thickness: 0.55 (0.022) 0.45 (0.018) Figure 9
Length of Snipped Lead			L	11.0 (0.433) Max.	
Lead Length Under Hold Down Tape			II	14.5 (0.571) Min.	

**Note:**

1. Dimensions in millimetres (inches) maximum/minimum.

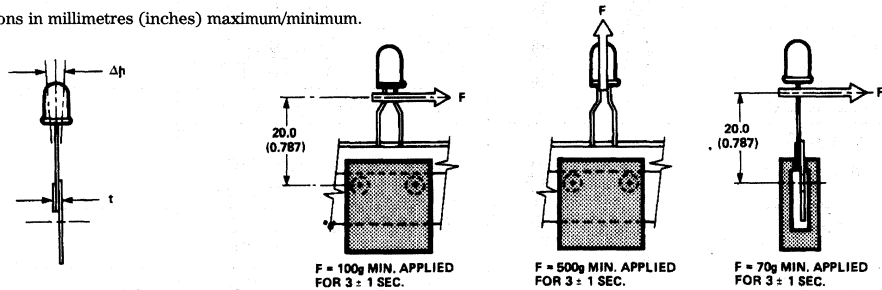

**Figure 9. Front to Rear Alignment and Tape Thickness, Typical All Device Types.**

**Figure 10. Device Retention Tests and Specifications.**

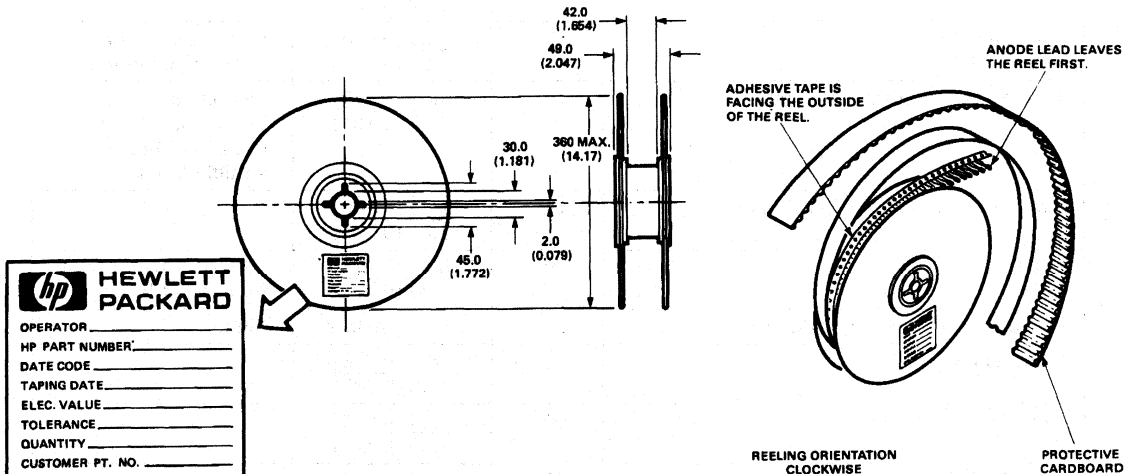

**Figure 11. Reel Configuration and Labeling.**

# T-1 (3 mm) Right Angle LED Indicators

## Technical Data

### Features

- Ideal for Card Edge Status Indication
- Package Design Allows Flush Seating on a PC Board
- May be Side Stacked on 4.57 mm (0.18") Centers
- Up to 8 Units May be Coupled for a Horizontal Array Configuration with a Common Coupling Bar (See T-1 Right Angle Array Data Sheet)
- LEDs Available in All LED Colors, With or Without Integrated Current Limiting Resistor in T-1 Packages
- Easy Flux Removal Design

- Housing Material Meets UL 94V-0 Rating
- Additional Catalog Lamps Available as Options

### Description

Hewlett-Packard T-1 Right Angle Indicators are industry standard status indicators that incorporate a T-1 LED lamp in a black plastic right angle mount housing. The indicators are available in Standard Red, High Efficiency Red, Orange, Yellow, and High Performance Green, with or without an integrated current limiting resistor. These products are designed to be used as back

### Option 010 Option 101

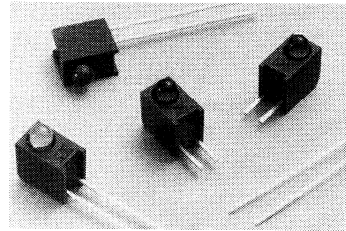

panel diagnostic indicators and card edge logic status indicators.

### Ordering Information

To order other T-1 High Dome Lamps in Right Angle Housings in addition to the parts indicated above, select the base part number and add the option code

### Package Dimensions

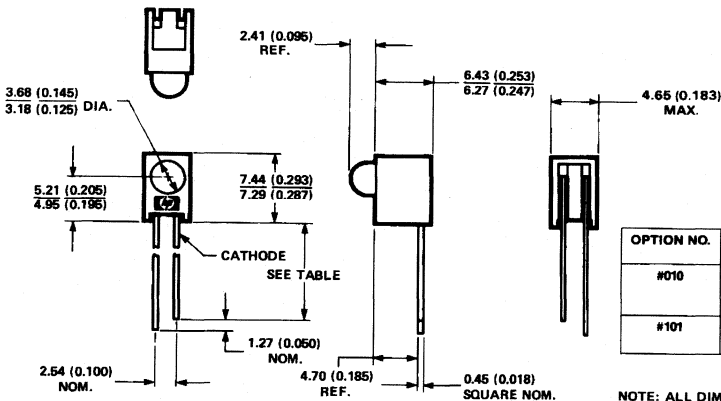

OPTION NO.	CATHODE LEAD LENGTH	ANODE LEAD LENGTH	
#010	18.03 (0.710) MIN.	1.27 (0.050) NOM. LONGER THAN CATHODE	UNSHEARED UNEVEN LEADS
#101	3.43 (0.135) MIN.	3.43 (0.135) MIN.	SHEARED EVEN LEADS

NOTE: ALL DIMENSIONS ARE IN MILLIMETRES ((INCHES).

010 or 101, depending on the lead length desired. For example, by ordering HLMP-1302 Option 010, you would receive the long lead option. By ordering HLMP-1302 Option 101, you would receive the short lead option.

Arrays made by connecting two to eight single Right Angle Indicators with a Common Coupling Bar are available. Ordering information for arrays may be found on the T-1 Right Angle Array data sheet.

### **Absolute Maximum Ratings and Other Electrical/Optical Characteristics**

The absolute maximum ratings and typical device characteristics are identical to those of the T-1 LED lamps. For information about these characteristics, see the data sheets of the equivalent T-1 LED lamp.



# T-1 (3 mm) Right Angle LED Indicator Array Options

## Technical Data

**Option 102, 103, 104,  
105, 106, 107, 108**

### Features

- Ideal for PC Board Status Indication
- Standard 4 Element Configuration
- Easy Handling
- Easy Flux Removal
- Housing Meets UL 94V-O Flammability Rating
- Other Catalog Lamps Available

### Description

These T-1 right angle arrays incorporate standard T-1 lamps for a good balance of viewing angle and intensity. Single units are held together by a plastic tie bar. The leads of each member of the array are spaced on 2.54 mm (0.100 in.) centers. Lead spacing between adjacent lamps in the array is on 2.03 mm (0.080 in.) centers. These products are

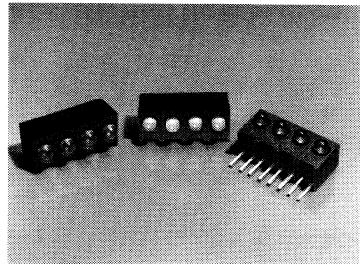

### Package Dimensions

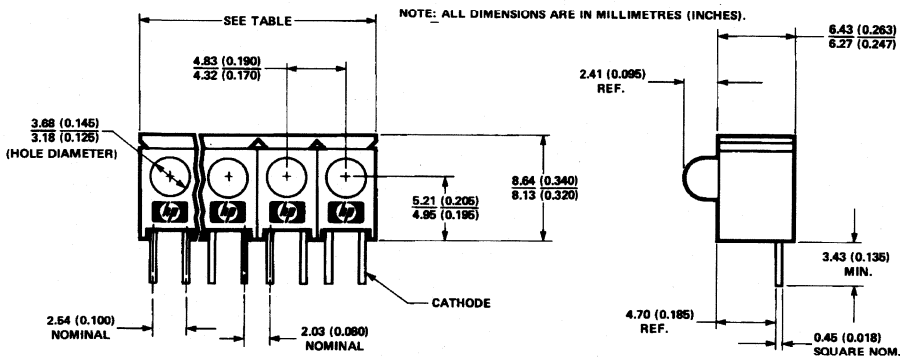

OPTION NO.	ARRAY LENGTH	OPTION NO.	ARRAY LENGTH	OPTION NO.	ARRAY LENGTH
#102	9.85 (0.380) 8.79 (0.346)	#105	23.14 (0.911) 22.73 (0.895)	#108	38.70 (1.445) 36.45 (1.435)
#103	14.22 (0.560) 13.36 (0.528)	#106	27.71 (1.091) 27.31 (1.075)		
#104	18.57 (0.731) 18.16 (0.715)	#107	32.28 (1.271) 31.88 (1.255)		

designed to be used as back panel diagnostic indicators and logic status indicators on PC boards.

### **Ordering Information**

Use the option code 102 through 108 in addition to the base part number to order these arrays.

Example: HLMP-1300 option 102. Arrays from 2 to 8 elements

in length and special lamp color combinations within an array are available. Please contact your nearest Hewlett-Packard Components representative for ordering information on these special items.

### **Absolute Maximum Ratings and Other Electrical/Optical Characteristics**

The absolute maximum ratings and typical device characteristics are identical to those of the T-1 LED lamps. For information about these characteristics, see the data sheets of the equivalent T-1 LED lamp.

# 2.5 mm x 7.6 mm Rectangular LED Lamps

## Technical Data

**HLMP-R100**  
**HLMP-0300/0301**  
**HLMP-0400/0401**  
**HLMP-0503/0504**

### Features

- **Rectangular Light Emitting Surface**
- **Flat High Sterance Emitting Surface**
- **Stackable on 2.54 mm (0.100 inch) Centers**
- **Ideal as Flush Mounted Panel Indicators**
- **Ideal for Backlighting Legends**
- **Long Life: Solid State Reliability**
- **Choice of 4 Bright Colors**
  - DH AS AlGaAs Red
  - High Efficiency Red
  - Yellow
  - High Performance Green
- **IC Compatible/Low Current Requirements**

The HLMP-R100 uses a double heterojunction (DH) absorbing substrate (AS) aluminum gallium arsenide (AlGaAs) red LED chip in a light red epoxy package. This combination produces outstanding light output over a wide range of drive currents.

The HLMP-0300 and -0301 have a high efficiency red GaAsP on GaP LED chip in a light red epoxy package.

The HLMP-0400 and -0401 provide a yellow GaAsP on GaP LED chip in a yellow epoxy package.

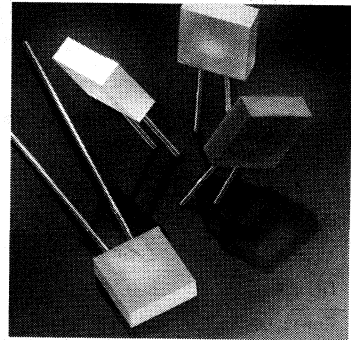

The HLMP-0503 and -0504 provide a green GaP LED chip in a green epoxy package.

### Description

The HLMP-R100, -030X, -040X, -050X are solid state lamps encapsulated in a radial lead rectangular epoxy package. They utilize a tinted, diffused epoxy to provide high on-off contrast and a flat high intensity emitting surface. Borderless package design allows creation of uninterrupted light emitting areas.

### Package Dimensions

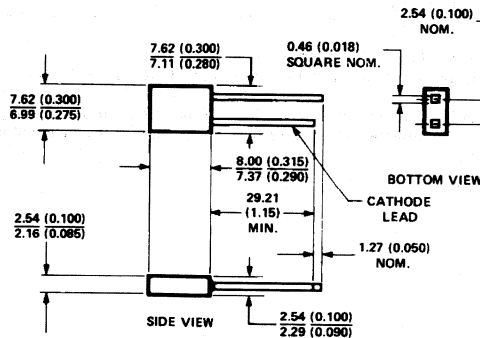

**NOTES:**

1. ALL DIMENSIONS ARE IN MILLIMETRES (INCHES).
2. AN EPOXY MENISCUS MAY EXTEND ABOUT 1 mm (0.040") DOWN THE LEADS.
3. THERE IS A MAXIMUM 1° TAPER FROM BASE TO TOP OF LAMP.

### Axial Luminous Intensity

Color	Part Number	$I_v$ (mcd) @ 20 mA DC	
		Min.	Typ.
DH AlGaAs Red	HLMP-R100	3.4	11.0
High Efficiency Red	HLMP-0300	1.3	2.5
	HLMP-0301	2.1	5.3
Yellow	HLMP-0400	1.4	2.5
	HLMP-0401	3.6	5.0
High Performance Green	HLMP-0503	1.6	2.5
	HLMP-0504	2.6	8.0

### Absolute Maximum Ratings at $T_A = 25^\circ\text{C}$

Parameter	HLMP-R100	HLMP-0300/-0301	HLMP-0400/0401	HLMP-0503/-0504	Units
Peak Forward Current	300	90	60	90	mA
Average Forward Current <sup>[1]</sup>	20	25	20	25	mA
DC Current <sup>[2]</sup>	30	30	20	30	mA
Power Dissipation	87	135	85	135	mW
Reverse Voltage ( $I_R = 100 \mu\text{A}$ )	5	5	5	5	V
Transient Forward Current <sup>[3]</sup> (10 $\mu\text{s}$ Pulse)	500	500	500	500	mA
Operating Temperature Range	-20 to +100	-55 to +100	-55 to +100	-20 to +100	$^\circ\text{C}$
Storage Temperature Range	-55 to +100			-55 to +100	
Lead Soldering Temperature (1.6 mm [0.063 in.] from body)	260 $^\circ\text{C}$ for 5 seconds				

#### Notes:

- See Figure 5 to establish pulsed operating conditions.
- For AlGaAs Red, Red, and Green Series derate linearly from 50 $^\circ\text{C}$  at 0.5 mA/ $^\circ\text{C}$ . For Yellow Series derate linearly from 50 $^\circ\text{C}$  at 0.2 mA/ $^\circ\text{C}$ .
- The transient peak current is the maximum non-recurring peak current that can be applied to the device without damaging the LED die and wirebond. It is not recommended that the device be operated at peak current beyond the peak forward current listed in the Absolute Maximum Ratings.

### Electrical/Optical Characteristics at $T_A = 25^\circ\text{C}$

Sym.	Description	HLMP-R100			HLMP-0300/0301			HLMP-0400/0401			HLMP-0503/0504			Units	Test Conditions
		Min.	Typ.	Max.	Min.	Typ.	Max.	Min.	Typ.	Max.	Min.	Typ.	Max.		
$2\theta_{1/2}$	Included Angle Between Half Luminous Intensity Points		100			100			100			100		Deg.	Note 1, Fig. 6
$\lambda_p$	Peak Wavelength		645			635			583			565		nm	Measurement at Peak
$\lambda_d$	Dominant Wavelength		637			626			585			569		nm	Note 2
$\Delta\lambda_{1/2}$	Spectral Line Halfwidth		20			40			36			28		nm	
$\tau_s$	Speed of Response		30			90			90			500		ns	
C	Capacitance		30			16			18			18		pF	$V_f = 0$ ; $f = 1 \text{ MHz}$
$R\theta_{J-PIN}$	Thermal Resistance		260			260			260			260		$^\circ\text{C/W}$	Junction to Cathode Lead
$V_f$	Forward Voltage		1.8	2.2		1.9	2.6		2.1	2.6		2.2	3.0	V	$I_f = 20 \text{ mA}$ Figure 2.
$V_R$	Reverse Breakdown Voltage	5.0			5.0			5.0			5.0			V	$I_R = 100 \mu\text{A}$
$\eta_v$	Luminous Efficacy		80			145			500			595		lm/W	Note 3

**Notes:**

- $\theta_{1/2}$  is the off-axis angle at which the luminous intensity is half the axial luminous intensity.
- The dominant wavelength,  $\lambda_d$ , is derived from the CIE chromaticity diagram and represents the single wavelength which defines the color of the device.
- Radiant intensity,  $I_s$ , in watts/steradian, may be found from the equation  $I_s = I_v/\eta_v$ , where  $I_v$  is the luminous intensity in candelas and  $\eta_v$  is the luminous efficacy in lumens/watt.

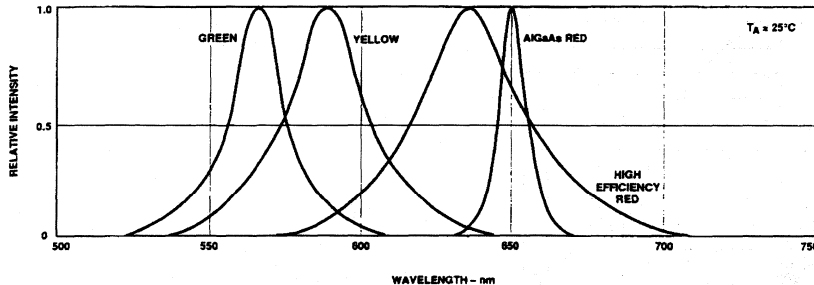

Figure 1. Relative Intensity vs. Wavelength.

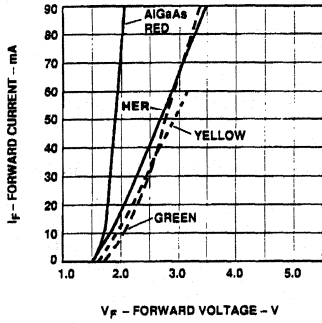

Figure 2. Forward Current vs. Forward Voltage.  $V_F$  (300 mA) for AlGaAs Red = 2.6 Volts Typical.

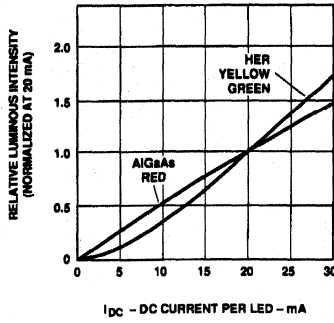

Figure 3. Relative Luminous Intensity vs. Forward Current.

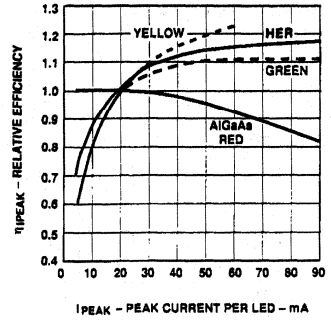

Figure 4. Relative Efficiency (Luminous Intensity per Unit Current) vs. Peak Current.  $\eta$ , (300 mA) for AlGaAs Red = 0.7.

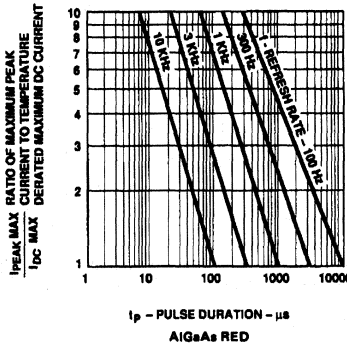
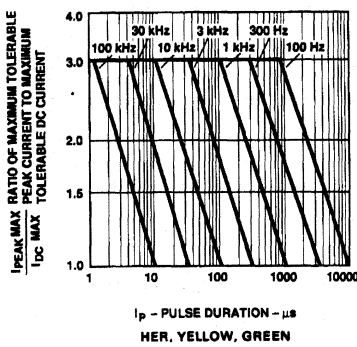

Figure 5. Maximum Tolerable Peak Current vs. Peak Duration ( $I_{PEAK MAX}$  Determined from Temperature Derated  $I_{DC MAX}$ ).

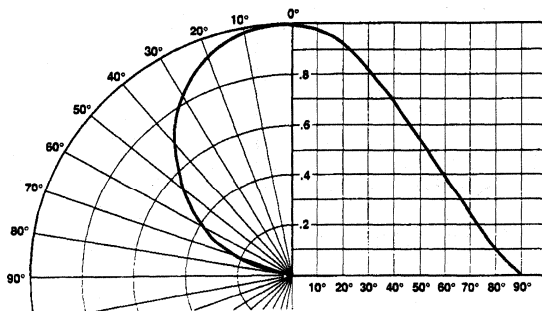

Figure 6. Relative Luminous Intensity vs. Angular Displacement.

# 2 mm x 5 mm Rectangular LED Lamps

## Technical Data

**HLMP-S100**  
**HLMP-S20X Series**  
**HLMP-S30X Series**  
**HLMP-S40X Series**  
**HLMP-S50X Series**  
**HLMP-S600**

### Features

- Rectangular Light Emitting Surface
- Excellent for Flush Mounting on Panels
- Choice of Five Bright Colors
- Long Life: Solid State Reliability
- Excellent Uniformity of Light Output

### Description

The HLMP-S100, -S200, -S300,

-S400, -S500, S600 are epoxy encapsulated lamps in rectangular packages which are easily stacked in arrays or used for discrete front panel indicators. Contrast and light uniformity are enhanced by a special epoxy diffusion and tinting process.

The HLMP-S100 uses double heterojunction (DH) absorbing substrate (AS) aluminum gallium arsenide (AlGaAs) LEDs to produce outstanding light output

### Package Dimensions

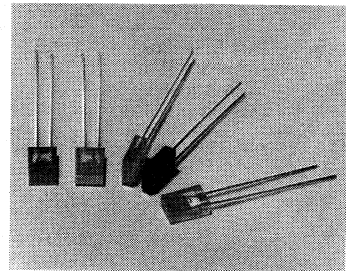
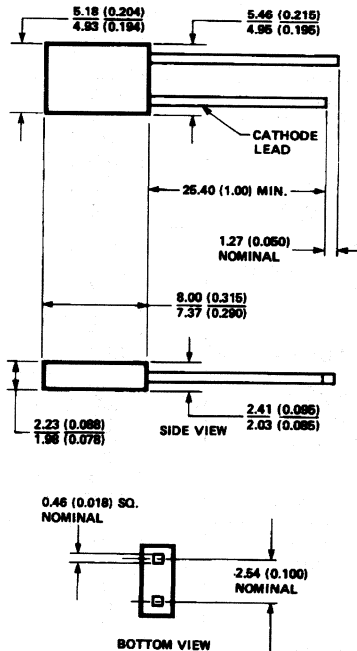

- NOTES:**
1. ALL DIMENSIONS ARE IN MILLIMETERS (INCHES)
  2. AN EPOXY MENISCUS MAY EXTEND ABOUT 1 mm (0.040") DOWN THE LEADS.
  3. THERE IS A MAXIMUM 1° TAPER FROM BASE TO THE TOP OF LAMP.

**Electrical/Optical Characteristics at  $T_A = 25^\circ\text{C}$** 

Sym.	Description	Device HLMP-	Min.	Typ.	Max.	Units	Test Conditions
$I_v$	Luminous Intensity	AlGaAs Red S100 High Efficiency Red S200 S201 Orange S400 S401 Yellow S300 S301 Green S500 S501 Emerald Green S600 <sup>[4]</sup>	3.4 2.1 3.4 2.1 3.4 1.4 2.2 2.6 4.2 1.0	7.5 3.5 7.5 3.5 7.5 2.1 4.0 4.0 8.0 3.0		mcd	$I_F = 20 \text{ mA}$
$2\theta_{1/2}$	Included Angle Between Half Luminous Intensity Points	All		110		Deg.	$I_F = 20 \text{ mA}$ See Note 1
$\lambda_{\text{PEAK}}$	Peak Wavelength	AlGaAs Red High Efficiency Red Orange Yellow Green Emerald Green		645 635 600 583 565 558		nm	Measurement at Peak
$\lambda_d$	Dominant Wavelength	AlGaAs Red High Efficiency Red Orange Yellow Green Emerald Green		637 626 602 585 569 560		nm	See Note 2 Time const, $e^{-t/\tau_s}$
$\tau_s$	Speed of Response	AlGaAs Red High Efficiency Red Orange Yellow Green Emerald Green		30 90 280 90 500 3100		ns	
C	Capacitance	AlGaAs Red High Efficiency Red Orange Yellow Green Emerald Green		30 11 4 15 18 35		pF	$V_F = 0$ ; $f = 1 \text{ MHz}$
$R\theta_{J-PIN}$	Thermal Resistance	All		260		$^\circ\text{C/W}$	Junction to Cathode Lead at Seating Plane
$V_F$	Forward Voltage	AlGaAs Red HER/Orange Yellow Green/Emerald Green	1.6 1.5 1.5 1.5	1.8 1.9 2.1 2.2	2.2 2.6 2.6 3.0	V	$I_F = 20 \text{ mA}$
$V_R$	Reverse Break-down Voltage	All	5.0			V	$I_R = 100 \mu\text{A}$



### Electrical/Optical Characteristics at $T_A = 25^\circ\text{C}$ (cont'd)

Sym.	Description	Device HLMP-	Min.	Typ.	Max.	Units	Test Conditions
$\eta_v$	Luminous Efficacy	AlGaAs Red High Efficiency Red Orange Yellow Green Emerald Green		80 145 380 500 595 656		lumens/ watt	See Note 3

**Notes:**

- $\theta_{1/2}$  is the off-axis angle at which the luminous intensity is half the axial luminous intensity.
- The dominant wavelength,  $\lambda_d$ , is derived from the CIE chromaticity diagram and represents the single wavelength which defines the color of the device.
- Radiant intensity,  $I_e$ , in watts/steradian, may be found from the equation  $I_e = I_v/\eta_v$ , where  $I_v$  is the luminous intensity in candelas and  $\eta_v$  is the luminous efficacy in lumens/watt.
- Please refer to Application Note 1061 for information comparing standard green and emerald green light output degradation.

### Absolute Maximum Ratings at $T_A = 25^\circ\text{C}$

Parameter	AlGaAs Red	High Efficiency Red/Orange	Yellow	Green/ Emerald Green	Units
Peak Forward Current	300	90	60	90	mA
Average Forward Current <sup>[1]</sup>	20	25	20	25	mA
DC Current <sup>[2]</sup>	30	30	20	30	mA
Transient Forward Current <sup>[3]</sup> (10 $\mu\text{sec}$ Pulse)	500				mA
LED Junction Temperature	110	110	110	110	$^\circ\text{C}$
Operating Temperature Range	-20 to +100	-55 to +100	-55 to +100	-20 to +100	$^\circ\text{C}$
Storage Temperature Range	-55 to +100			-55 to +100	
Lead Soldering Temperature [1.6 mm (0.063 in.) below seating plane]	260 $^\circ\text{C}$ for 5 seconds				

**Notes:**

- See Figure 5 to establish pulsed operating conditions.
- For AlGaAs Red, Red, Orange, and Green series derate linearly from 50 $^\circ\text{C}$  at 0.5 mA/ $^\circ\text{C}$ . For Yellow series derate linearly from 50 $^\circ\text{C}$  at 0.34 mA/ $^\circ\text{C}$ .
- The transient peak current is the maximum non-recurring peak current that can be applied to the device without damaging the LED die and wire bond. It is not recommended that the device be operated at peak currents beyond the peak forward current listed in the Absolute Maximum Ratings.

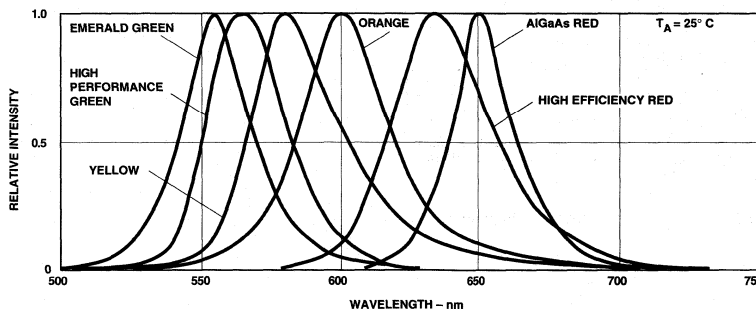

Figure 1. Relative Intensity vs. Wavelength.

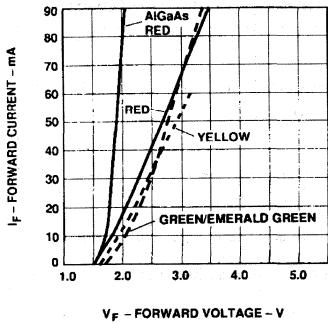

Figure 2. Forward Current vs. Forward Voltage Characteristics.  $V_F$  (300 mA) for AlGaAs Red = 2.6 Volts Typical.

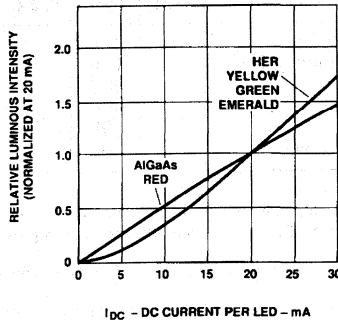

Figure 3. Relative Luminous Intensity vs. DC Forward Current.

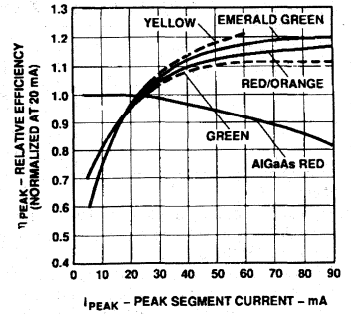

Figure 4. Relative Efficiency (Luminous Intensity per Unit Current) vs. LED Peak Current.  $\eta_V$  (300 mA) for AlGaAs Red = 0.7.

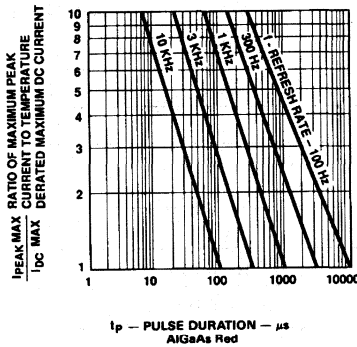
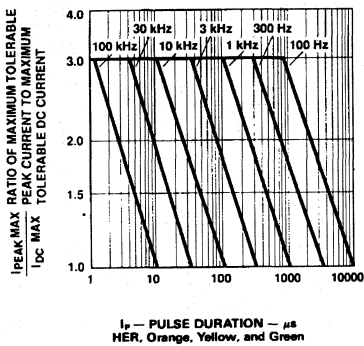

Figure 5. Maximum Tolerable Peak Current vs. Peak Duration. ( $I_{PEAK\ MAX}$  Determined from Temperature Derated  $I_{DC\ MAX}$ ).

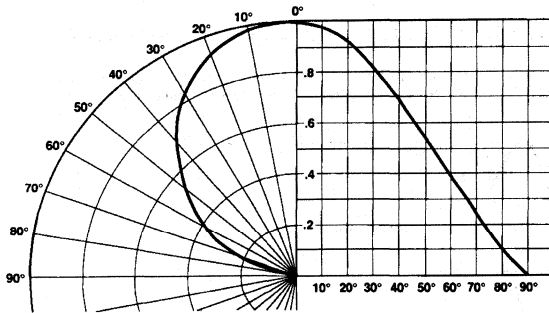

Figure 6. Relative Luminous Intensity vs. Angular Displacement.

# T-1<sup>3/4</sup>, 2 mm X 5 mm Rectangular Bicolor LED Lamps High Efficiency Red/ High Performance Green

## Technical Data

### Features:

- Two Color (Red, Green) Operation
- (Other Two LED Color Combinations Available)
- Three Leads with One Common Cathode
- Option of Straight or Spread Lead Configurations
- Diffused, Wide Visibility Lens

### Description

The T-1 3/4 HLMP-4000 and 2 mm by 5 mm rectangular HLMP-0800 are three leaded bicolor light sources designed for a variety of applications where dual state illumination is required in the same package. There are two LED chips, high efficiency red (HER), and high performance green (Green), mounted on a central common cathode lead for maximum on-axis viewability. Colors between HER and Green can be generated by independently pulse width modulating the LED chips.

### Other Bicolor Combinations

Other bicolor combinations are available:

- HER/yellow
- HER/green
- DH AlGaAs red/green.

Contact your local Hewlett-Packard Components Field Sales representative for details.

### HLMP-4000 HLMP-0800

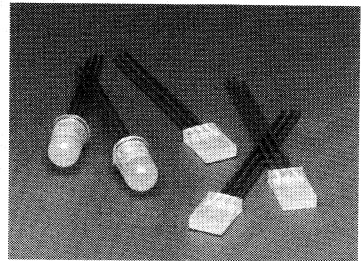

### Package Dimensions

#### HLMP-4000

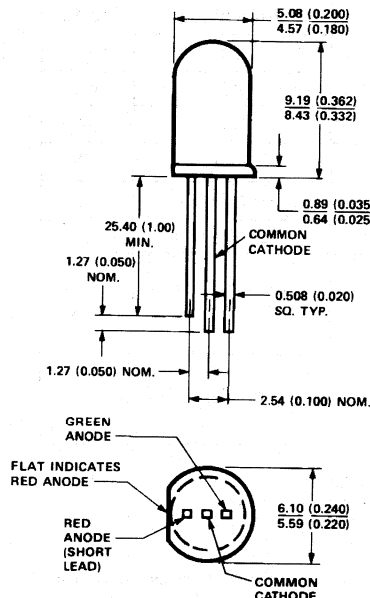

#### HLMP-0800

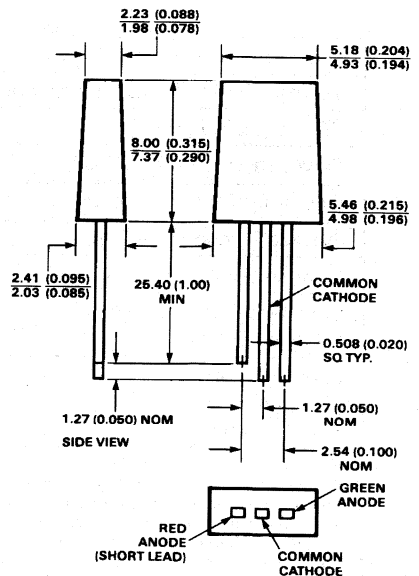

- NOTES:  
1. ALL DIMENSIONS ARE IN MILLIMETRES (INCHES).  
2. AN EPOXY MENISCUS MAY EXTEND ABOUT 1 mm (0.040") DOWN THE LEADS.

## Package Dimensions, continued

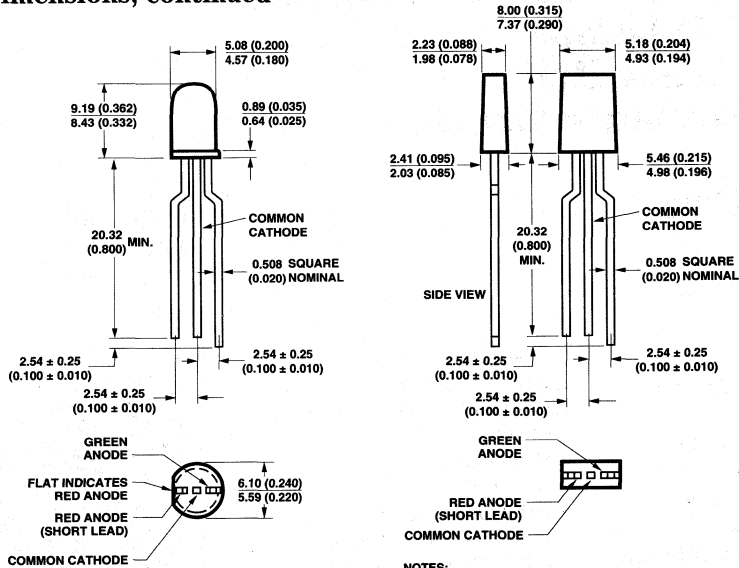

- NOTES:  
 1. ALL DIMENSIONS ARE IN MILLIMETERS (INCHES).  
 2. AN EPOXY MENISCUS MAY EXTEND ABOUT 1 MM (0.040") DOWN THE LEADS.

## Absolute Maximum Ratings at $T_A = 25^\circ\text{C}$

Parameter	High Efficiency Red/Green	Units
Peak Forward Current	90	mA
Average Forward Current <sup>[1,2]</sup> (Total)	25	mA
DC Current <sup>[2,4]</sup> (Total)	30	mA
Power Dissipation <sup>[3,5]</sup> (Total)	135	mW
Operating Temperature Range	-20 to +85	°C
Storage Temperature Range	-55 to +100	
Reverse Voltage ( $I_R = 100 \mu\text{A}$ )	5	V
Transient Forward Current <sup>[6]</sup> (10 $\mu\text{sec}$ Pulse)	500	mA
Lead Soldering Temperature [1.6 mm (0.063 in.) below seating plane]	260°C for 5 seconds	

### Notes:

- See Figure 5 to establish pulsed operating conditions.
- The combined simultaneous current must not exceed the maximum.
- The combined simultaneous power must not exceed the maximum.
- For HER and Green derate linearly from 50°C at 0.5 mA/°C.
- For HER and Green derate linearly from 25°C at 1.8 mW/°C.
- The transient peak current is the maximum non-recurring current that can be applied to the device without damaging the LED die and wirebond. It is not recommended that the device be operated at peak currents beyond the peak forward current listed in the Absolute Maximum Ratings.

**Electrical/Optical Characteristics at T<sub>A</sub> = 25°C**

Sym.	Parameter	Red			Green			Units	Test Conditions
		Min.	Typ.	Max.	Min.	Typ.	Max.		
I <sub>V</sub>	Luminous Intensity HLMP-4000	2.1	5		4.2	8		mcd	I <sub>F</sub> = 10 mA
	HLMP-0800	2.1	3.5		2.6	4.0			I <sub>F</sub> = 20 mA
λ <sub>PEAK</sub>	Peak Wavelength		635		565			nm	
λ <sub>d</sub>	Dominant Wavelength <sup>[1]</sup>		626		569				
τ <sub>s</sub>	Speed of Response		90		500			ns	
C	Capacitance		11		18			pF	V <sub>F</sub> = 0, f = 1 MHz
V <sub>F</sub>	Forward Voltage		1.9	2.4	2.1	2.7		V	I <sub>F</sub> = 10 mA
V <sub>R</sub>	Reverse Breakdown Voltage	5			5			V	I <sub>R</sub> = 100 μA
Rθ <sub>J-PIN</sub>	Thermal Resistance		260		260			°C/W	Junction to Cathode Lead
2θ <sup>1/2</sup>	Included Angle Between Half Luminous Intensity Points <sup>[2]</sup>							Deg.	I <sub>F</sub> = 10 mA I <sub>F</sub> = 20 mA
	HLMP-4000		65		65				
	HLMP-0800		100		100				
η <sub>V</sub>	Luminous Efficacy <sup>[3]</sup>		145		595			Lumen/Watt	

**Notes:**

1. The dominant wavelength, λ<sub>d</sub>, is derived from the CIE chromaticity diagram and represents the single wavelength which defines the color of the device.
2. θ<sup>1/2</sup> is the off-axis angle at which the luminous intensity is half the axial luminous intensity.
3. Radiant intensity, I<sub>e</sub>, in watts steradian, may be found from the equation I<sub>e</sub> = I<sub>v</sub>/η<sub>v</sub>, where I<sub>v</sub> is the luminous intensity in candelas and η<sub>v</sub> is the luminous efficacy in lumens/watt.

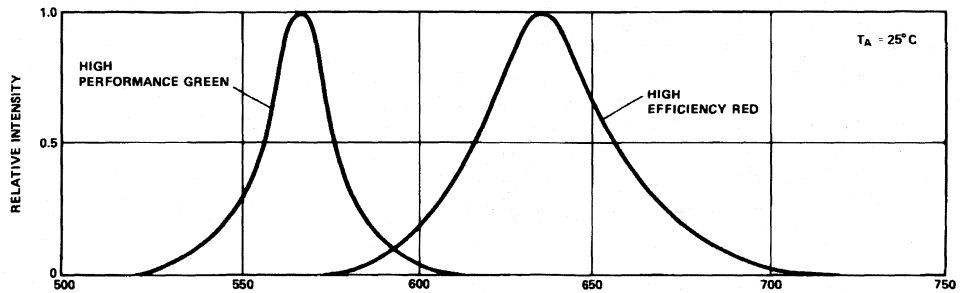

Figure 1. Relative Intensity vs. Wavelength.

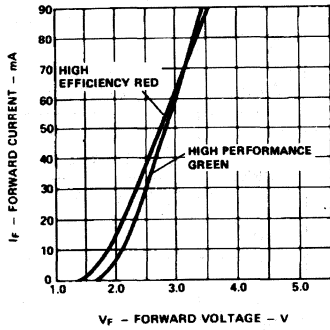

Figure 2. Forward Current vs. Forward Voltage Characteristics.

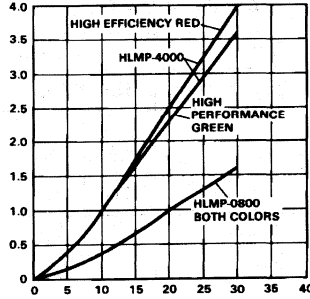

Figure 3. Relative Luminous Intensity vs. DC Forward Current.

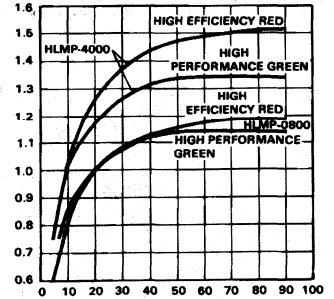

Figure 4. Relative Efficiency (Luminous Intensity per Unit Current) vs. Peak LED Current.

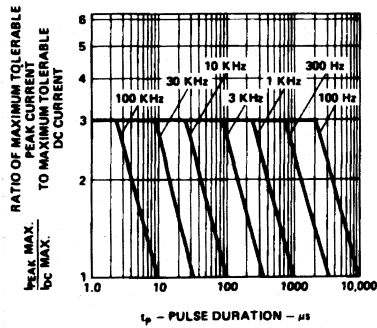

Figure 5. Maximum Tolerable Peak Current vs. Pulse Duration. ( $I_{DC}$  MAX as per MAX Ratings).

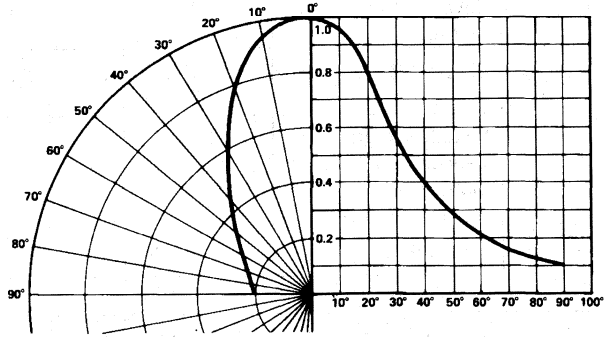

Figure 6. Relative Luminous Intensity vs. Angular Displacement for the HLMP-4000.

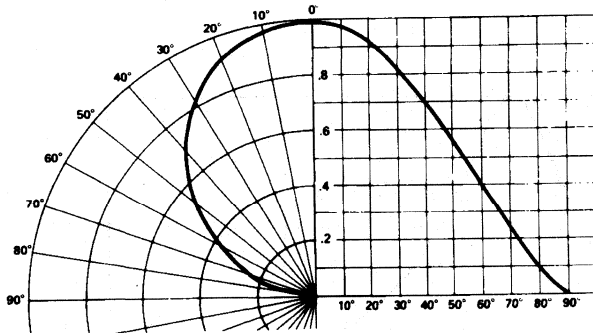

Figure 7. Relative Luminous Intensity vs. Angular Displacement for the HLMP-0800.

# Subminiature High Performance AlInGaP LED Lamps

## Technical Data

### SunPower Series

**HLMA-PH00 HLMT-PH00**  
**HLMA-PL00 HLMT-PL00**  
**HLMA-QH00 HLMT-QH00**  
**HLMA-QL00 HLMT-QL00**

### Features

- **Subminiature Flat Top Package**  
Ideal for Backlighting and Light Piping Applications
- **Subminiature Dome Package**  
Nondiffused Dome for High Brightness
- **Wide Range of Drive Currents**
- **Colors: 590 nm Amber, 615 nm Reddish-Orange**
- **Ideal for Space Limited Applications**
- **Axial Leads**
- **Available with Lead Configurations for Surface Mount and Through Hole PC Board Mounting**

### Description

#### Flat Top Package

The HLMX-PXXX flat top lamps use an untinted, nondiffused, truncated lens to provide a wide radiation pattern that is necessary for use in backlighting applications. The flat top lamps are also ideal for use as emitters in light pipe applications.

#### Dome Packages

The HLMX-QXXX dome lamps use an untinted, nondiffused lens to provide a high luminous intensity within a narrow radiation pattern.

#### Lead Configurations

All of these devices are made by encapsulating LED chips on axial lead frames to form molded epoxy subminiature lamp packages. A variety of package configuration options is available. These include special surface mount lead configurations, gull wing, yoke lead, or Z-bend. Right angle lead bends at 2.54 mm (0.100 inch) and 5.08 mm (0.200 inch) center spacing are available for through hole mounting. For more information refer to Standard SMT and Through Hole Lead Bend Options for Subminiature LED Lamps data sheet.

#### Technology

These subminiature solid state lamps utilize one of the two newly

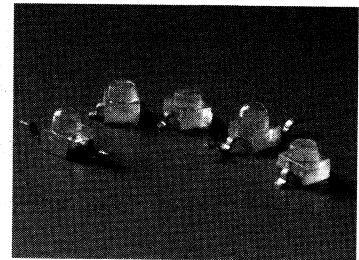

developed aluminum indium gallium phosphide (AlInGaP) LED technologies, either the absorbing substrate carrier technology (AS = HLMA-Devices) or the transparent substrate carrier technology (TS = HLMT-Devices). The TS HLMT-Devices are especially effective in very bright ambient lighting conditions. The colors 590 nm amber and 615 nm reddish-orange are available with viewing angles of 15° for the domed devices and 125° for the flat top devices.

## Device Selection Guide

Package Description	Viewing Angle 2θ <sup>1/2</sup>	Amber λ <sub>d</sub> = 590 nm	Reddish-Orange λ <sub>d</sub> = 615 nm	Package Outline
Domed, Nondiffused Untinted	28°	HLMA-QL00 HLMT-QL00	HLMA-QH00 HLMT-QH00	B
Flat Top, Nondiffused, Untinted	125°	HLMA-PL00 HLMT-PL00	HLMA-PH00 HLMT-PH00	A

## Package Dimensions

### (A) Flat Top Lamps

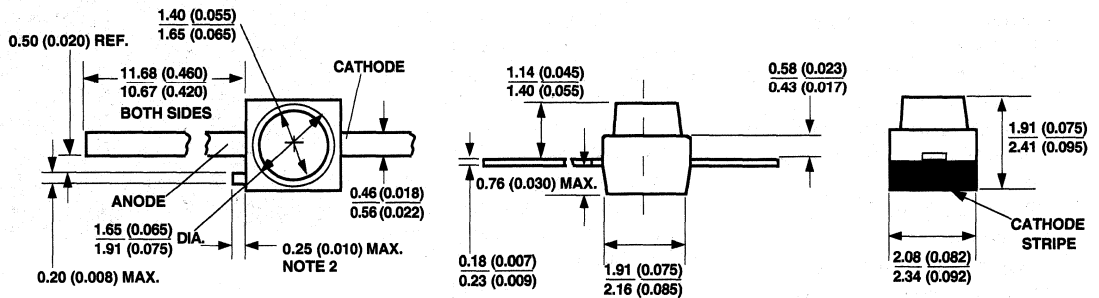

### (B) Domed Lamps, Diffused and Nondiffused

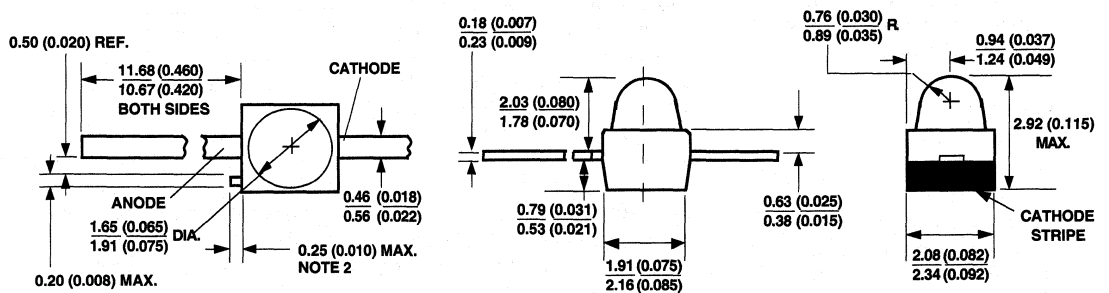

#### NOTES:

- ALL DIMENSIONS ARE IN MILLIMETERS (INCHES).
- PROTRUDING SUPPORT TAB IS CONNECTED TO CATHODE LEAD.



**Absolute Maximum Ratings at  $T_A = 25^\circ\text{C}$**

**HLMA-QL00/QH00/PL00/PH00**

Peak Forward Current <sup>[2]</sup> .....	200 mA
Average Forward Current ( $I_{PEAK} = 200\text{ mA}$ ) <sup>[1,2]</sup> .....	45 mA
DC Forward Current <sup>[3,5,6]</sup> .....	50 mA
Power Dissipation .....	105 mW

**HLMT-QL00/QH00/PL00/PH00**

Peak Forward Current <sup>[2]</sup> .....	100 mA
Average Forward Current ( $I_{PEAK} = 100\text{ mA}$ ) <sup>[1,2]</sup> .....	37 mA
DC Forward Current <sup>[3,5,6]</sup> .....	50 mA
Power Dissipation .....	120 mW

**All Devices**

Reverse Voltage ( $I_R = 100\ \mu\text{A}$ ) .....	5 V
Transient Forward Current (10 $\mu\text{s}$ Pulse) <sup>[5]</sup> .....	500 mA
Operating Temperature Range .....	-40 to +100°C
Storage Temperature Range .....	-55 to +100°C
LED Junction Temperature .....	110°C
Lead Soldering Temperature	
[1.6 mm (0.063 in.) from body] .....	260°C for 5 seconds
SMT Reflow Soldering Temperatures	
Convective Reflow .....	235°C Peak, above 183°C for 90 seconds
Vapor Phase Reflow .....	215°C for 3 minutes

**Notes:**

1. Maximum  $I_{AVG}$  at  $f = 1\text{ kHz}$ .
2. Refer to Figure 6 to establish pulsed operating conditions.
3. Derate linearly as shown in Figure 4.
4. The transient peak current is the maximum non-recurring peak current these devices can withstand without damaging the LED die and wire bonds. Operation at currents above Absolute Maximum Peak Forward Current is not recommended.
5. Drive currents between 5 mA and 30 mA are recommended for best long term performance.
6. Operation at currents below 5 mA is not recommended, please contact your Hewlett-Packard sales representative.

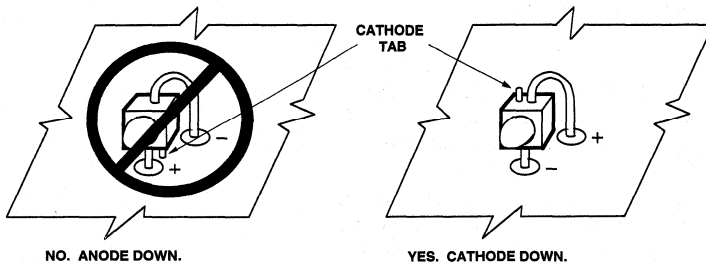

Figure 1. Proper Right Angle Mounting to a PC Board to Prevent Protruding Cathode Tab from Shorting to Anode Connection.

### Optical Characteristics at $T_A = 25^\circ\text{C}$

Part Number HLMA-	Luminous Intensity $I_v$ (mcd) @ 20 mA <sup>[1]</sup>		Total Flux $\phi_v$ (mlm) @ 20 mA <sup>[2]</sup> Typ.	Peak Wavelength $\lambda_{\text{peak}}$ (nm) Typ.	Color, Dominant Wavelength $\lambda_d$ <sup>[3]</sup> (nm) Typ.	Viewing Angle $2 \theta_{1/2}$ Degrees <sup>[4]</sup> Typ.	Luminous Efficacy $\eta_v$ <sup>[5]</sup> (lm/w)
	Min.	Typ.					
QL00	135	500	250	592	590	15	480
QH00	135	500	250	621	615	15	263
PL00	23	75	250	592	590	125	480
PH00	22	75	250	621	615	125	263
<b>HLMT-</b>							
QL00	300	1000	800	592	590	15	480
QH00	290	800	800	621	615	15	263
PL00	46	150	800	592	590	125	480
PH00	35	120	800	621	615	125	263

**Notes:**

1. The luminous intensity,  $I_v$ , is measured at the mechanical axis of the lamp package. The actual peak of the spatial radiation pattern may not be aligned with this axis.
2.  $\phi_v$  is the total luminous flux output as measured with an integrating sphere.
3. The dominant wavelength,  $\lambda_d$ , is derived from the CIE Chromaticity Diagram and represents the color of the device.
4.  $\theta_{1/2}$  is the off-axis angle where the luminous intensity is 1/2 the peak intensity.
5. Radiant intensity,  $I_r$ , in watts/steradian, may be calculated from the equation  $I_r = I_v/\eta_v$ , where  $I_v$  is the luminous intensity in candelas and  $\eta_v$  is the luminous efficacy in lumens/watt.

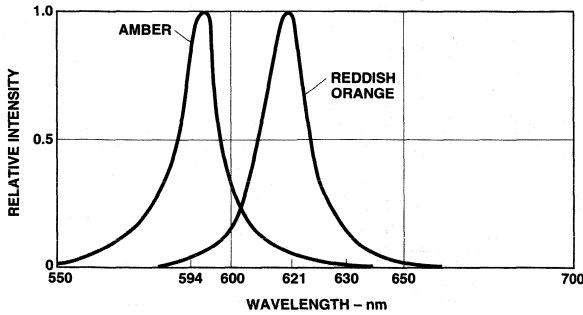

Figure 1. Relative Intensity vs. Wavelength. All Devices.

**Electrical Characteristics at  $T_A = 25^\circ\text{C}$**

Part Number	Forward Voltage $V_F$ (Volts) @ $I_F = 20 \text{ mA}$		Reverse Breakdown $V_R$ (Volts) @ $I_R = 100 \mu\text{A}$		Capacitance $C$ (pF) $V_F = 0, f = 1 \text{ MHz}$ Typ.	Thermal Resistance $R\theta_{J, PIN}$ ( $^\circ\text{C/W}$ )	Speed of Response $\tau_s$ (ns) Time Constant $e^{-t/\tau_s}$ Typ.
	Typ.	Max.	Min.	Typ.			
HLMA-QL00	1.9	2.4	5	25	40	170	13
HLMA-QH00	1.9	2.4	5	25	40	170	13
HLMA-PL00	1.9	2.4	5	25	40	170	13
HLMA-PH00	1.9	2.4	5	25	40	170	13
HLMT-							
QL00	2.0	2.4	5	20	70	170	13
QH00	2.0	2.4	5	20	70	170	13
PL00	2.0	2.4	5	20	70	170	13
PH00	2.0	2.4	5	20	70	170	13

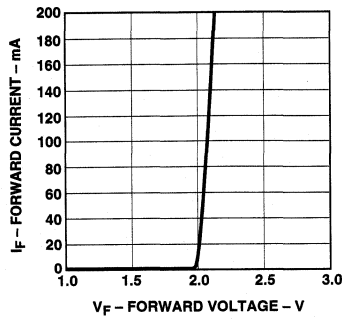

Figure 2a. Forward Current vs. Forward Voltage. HLMA-QL00/QH00/PL00/PH00.

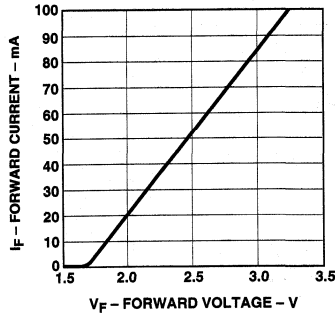

Figure 2b. Forward Current vs. Forward Voltage. HLMT-QL00/QH00/PL00/PH00.

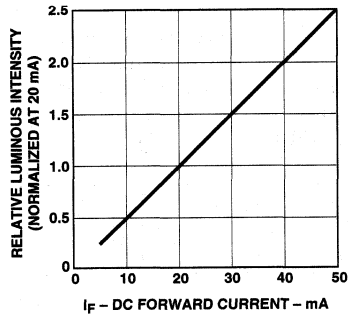

Figure 3a. Relative Luminous Intensity vs. DC Forward Current. HLMA-QL00/QH00/PL00/PH00.

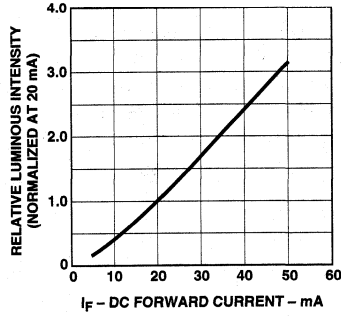

Figure 3b. Relative Luminous Intensity vs. DC Forward Current. HLMT-QL00/QH00/PL00/PH00.

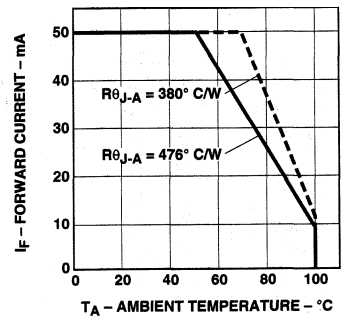

Figure 4. Maximum Forward Current vs. Ambient Temperature for HLMA-/HLMT-QL00/QH00/PL00/PH00. Derating Based on  $T_{j,MAX} = 110^{\circ}C$ .

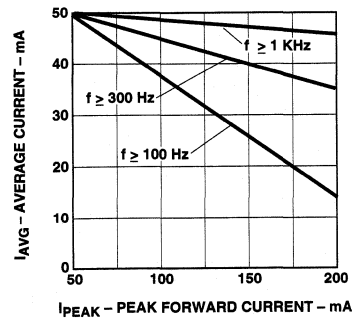

Figure 5a. Maximum Average Current vs. Peak Forward Current for HLMA-QL00/QH00/PL00/PH00.

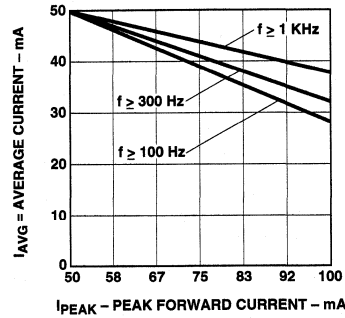

Figure 5b. Maximum Average Current vs. Peak Forward Current for HLMT-QL00/QH00/PL00/PH00.

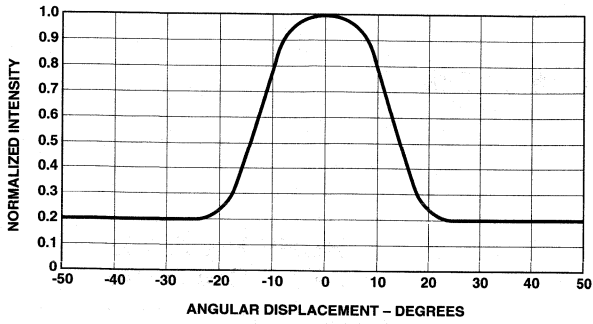

Figure 6. Relative Luminous Intensity vs. Angular Displacement for HLMA-/HLMT-QL00/-QH00.

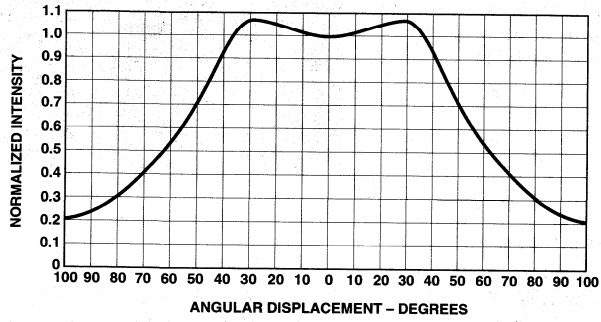

Figure 7. Relative Luminous Intensity vs. Angular Displacement for HLMA-/HLMT-PL00/-PH00.

---

# Subminiature High Performance TS AlGaAs Red LED Lamps

## Technical Data

---

**HLMP-P106/P156**  
**HLMP-Q10X/Q15X**

---

### Features

- **Subminiature Flat Top Package**  
Ideal for Backlighting and Light Piping Applications
- **Subminiature Dome Package**  
Diffused Dome for Wide Viewing Angle  
Non-diffused Dome for High Brightness
- **Wide Range of Drive Currents**  
500  $\mu$ A to 50 mA
- **Ideal for Space Limited Applications**
- **Axial Leads**
- **Available with lead configurations for Surface Mount and Through Hole PC Board Mounting**

### Description

#### Flat Top Package

The HLMP-PXXX Series flat top lamps use an untinted, non-diffused, truncated lens to provide a wide radiation pattern that is necessary for use in backlighting applications. The flat top lamps are also ideal for use as emitters in light pipe applications.

### Dome Packages

The HLMP-QXXX Series dome lamps, for use as indicators, use a tinted, diffused lens to provide a wide viewing angle with high on-off contrast ratio. High brightness lamps use an untinted, nondiffused lens to provide a high luminous intensity within a narrow radiation pattern.

### Lead Configurations

All of these devices are made by encapsulating LED chips on axial lead frames to form molded epoxy subminiature lamp packages. A variety of package configuration options is available. These include special surface mount lead configurations, gull wing, yoke lead, or Z-bend. Right angle lead bends at 2.54 mm (0.100 inch) and 5.08 mm (0.200 inch) center spacing are available for through hole mounting. For more information refer to Standard SMT and Through Hole Lead Bend Options for Subminiature LED Lamps data sheet.



### Technology

These subminiature solid state lamps utilize a highly optimized LED material technology, transparent substrate aluminum gallium arsenide (TS AlGaAs). This LED technology has a very high luminous efficiency, capable of producing high light output over a wide range of drive currents (500  $\mu$ A to 50 mA). The color is deep red at a dominant wavelength of 644 nm deep red. TS AlGaAs is a flip-chip LED technology, die attached to the anode lead and wire bonded to the cathode lead. Available viewing angles are 75°, 35°, and 15°.

## Device Selection Guide

Package Description	Viewing Angle $2\theta_{1/2}$	Deep Red $R_d = 644\text{ nm}$	Typical $I_v$ $I_f = 500\ \mu\text{A}$	Typical $I_v$ $I_f = 20\text{ mA}$	Package Outline
Domed, Diffused Tinted, Standard Current	35	HLMP-Q102		160	B
Domed, Diffused Tinted, Low Current	35	HLMP-Q152	2		B
Domed, Nondiffused Untinted, Standard Current	15	HLMP-Q106		530	B
Domed, Nondiffused Untinted, Low Current	15	HLMP-Q156	7		B
Flat Top, Nondiffused, Untinted, Standard Current	75	HLMP-P106		130	A
Flat Top, Nondiffused Untinted, Low Current	75	HLMP-P156	2		A

## Package Dimensions

### A) Flat Top Lamps

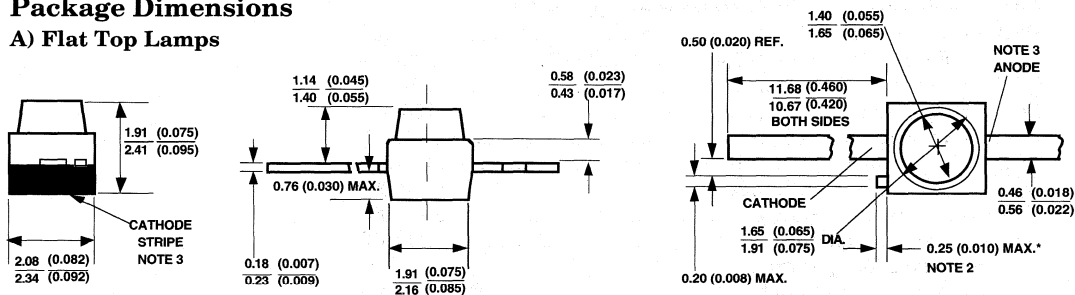

\* REFER TO FIGURE 1 FOR DESIGN CONCERNS.

### B) Diffused and Nondiffused Dome Lamps

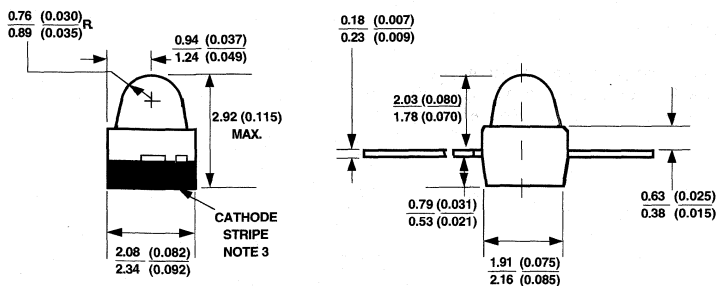

#### NOTES:

1. ALL DIMENSIONS ARE IN MILLIMETRES (INCHES).
2. PROTRUDING SUPPORT TAB IS CONNECTED TO ANODE LEAD.
3. LEAD POLARITY FOR THESE TS AlGaAs SUBMINIATURE LAMPS IS OPPOSITE TO THE LEAD POLARITY OF SUBMINIATURE LAMPS USING OTHER LED TECHNOLOGIES.

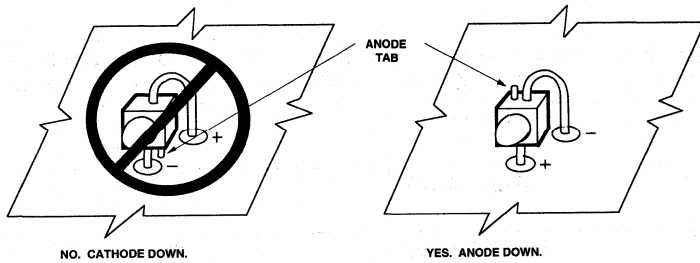

**Figure 1. Proper Right Angle Mounting to a PC Board to Prevent Protruding Anode Tab from Shorting to Cathode Connection.**

### Absolute Maximum Ratings at $T_A = 25^\circ\text{C}$

Peak Forward Current <sup>[2]</sup> .....	300 mA
Average Forward Current (@ $I_{\text{PEAK}} = 300 \text{ mA}$ ) <sup>[1,2]</sup> .....	30 mA
DC Forward Current <sup>[3]</sup> .....	50 mA
Power Dissipation .....	100 mW
Reverse Voltage ( $I_R = 100 \mu\text{A}$ ) .....	5 V
Transient Forward Current (10 $\mu\text{s}$ Pulse) <sup>[4]</sup> .....	500 mA
Operating Temperature Range .....	-55 to +100°C
Storage Temperature Range .....	-55 to +100°C
LED Junction Temperature .....	110°C
Lead Soldering Temperature	
[1.6 mm (0.063 in.) from body] .....	260°C for 5 seconds
Reflow Soldering Temperatures	
Convective IR .....	235°C Peak, above 183°C for 90 seconds
Vapor Phase .....	215°C for 3 minutes

#### Notes:

1. Maximum  $I_{\text{AVG}}$  at  $f = 1 \text{ kHz}$ ,  $\text{DF} = 10\%$ .
2. Refer to Figure 7 to establish pulsed operating conditions.
3. Derate linearly as shown in Figure 6.
4. The transient peak current is the maximum non-recurring peak current the device can withstand without damaging the LED die and wire bonds. It is not recommended that the device be operated at peak currents above the Absolute Maximum Peak Forward Current.



### Optical Characteristics at $T_A = 25^\circ\text{C}$

Part Number HLMP-	Luminous Intensity $I_v$ (mcd) @ 20 mA <sup>[1]</sup>		Total Flux $\phi_v$ (mlm) @ 20 mA <sup>[2]</sup> Typ.	Peak Wavelength $\lambda_{\text{peak}}$ (nm) Typ.	Color, Dominant Wavelength $\lambda_d$ <sup>[3]</sup> (nm) Typ.	Viewing Angle 20 <sup>1/2</sup> Degrees <sup>[4]</sup> Typ.	Luminous Efficacy $\eta_v$ <sup>[5]</sup> (lm/w)
	Min.	Typ.					
Q106	56	530	280	654	644	15	85
Q102	22	160	-	654	644	35	85
P106	22	130	280	654	644	75	85

### Optical Characteristics at $T_A = 25^\circ\text{C}$

Part Number (Low Current) HLMP-	Luminous Intensity $I_v$ (mcd) @ 0.5 mA <sup>[1]</sup>		Total Flux $\phi_v$ (mlm) @ 0.5 mA <sup>[2]</sup> Typ.	Peak Wavelength $\lambda_{\text{peak}}$ (nm) Typ.	Color, Dominant Wavelength $\lambda_d$ <sup>[3]</sup> (nm) Typ.	Viewing Angle 20 <sup>1/2</sup> Degrees <sup>[4]</sup> Typ.	Luminous Efficacy $\eta_v$ <sup>[5]</sup> (lm/w)
	Min.	Typ.					
Q156	2.1	7	10.5	654	644	15	85
Q152	1.3	2	-	654	644	35	85
P156	0.6	2	10.5	654	644	75	85

**Notes:**

1. The luminous intensity,  $I_v$ , is measured at the mechanical axis of the lamp package. The actual peak of the spatial radiation pattern may not be aligned with this axis.
2.  $\phi_v$  is the total luminous flux output as measured with an integrating sphere.
3. The dominant wavelength,  $\lambda_d$ , is derived from the CIE Chromaticity Diagram and represents the color of the device.
4. 0<sup>1/2</sup> is the off-axis angle where the luminous intensity is 1/2 the peak intensity.
5. Radiant intensity,  $I_v$ , in watts/steradian, may be calculated from the equation  $I_v = I_v/\eta_v$ , where  $I_v$  is the luminous intensity in candelas and  $\eta_v$  is the luminous efficacy in lumens/watt.

### Electrical Characteristics at $T_A = 25^\circ\text{C}$

Part Number HLMP-	Forward Voltage $V_F$ (Volts) @ $I_F = 20\text{ mA}$		Reverse Breakdown $V_R$ (Volts) @ $I_R = 100\ \mu\text{A}$		Capacitance C (pF) $V_F = 0,$ $f = 1\text{ MHz}$ Typ.	Thermal Resistance $R\theta_{J-PIN}$ ( $^\circ\text{C/W}$ )	Speed of Response $\tau_s$ (ns) Time Constant $e^{-t/\tau_s}$ Typ.
	Typ.	Max.	Min.	Typ.			
Q106	1.9	2.4	5	20	20	170	45
Q102	1.9	2.4	5	20	20	170	45
P106	1.9	2.4	5	20	20	170	45

### Electrical Characteristics at $T_A = 25^\circ\text{C}$

Part Number (Low Current) HLMP-	Forward Voltage $V_F$ (Volts) @ $I_F = 0.5\text{ mA}$		Reverse Breakdown $V_R$ (Volts) @ $I_R = 100\ \mu\text{A}$		Capacitance C (pF) $V_F = 0,$ $f = 1\text{ MHz}$ Typ.	Thermal Resistance $R\theta_{J-PIN}$ ( $^\circ\text{C/W}$ )	Speed of Response $\tau_s$ (ns) Time Constant $e^{-t/\tau_s}$ Typ.
	Typ.	Max.	Min.	Typ.			
Q156	1.6	1.9	5	20	20	170	45
Q152	1.6	1.9	5	20	20	170	45
P156	1.6	1.9	5	20	20	170	45

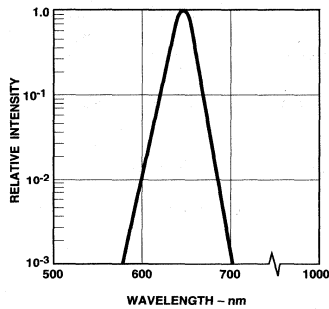

Figure 2. Relative Intensity vs. Wavelength.

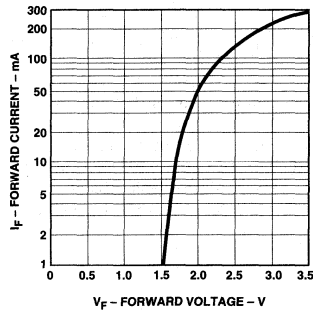

Figure 3. Forward Current vs. Forward Voltage.

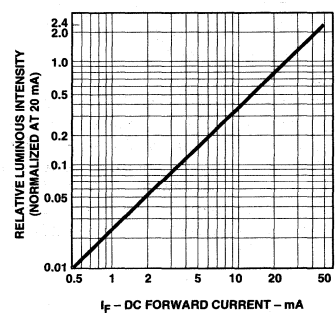

Figure 4. Relative Luminous Intensity vs. DC Forward Current.

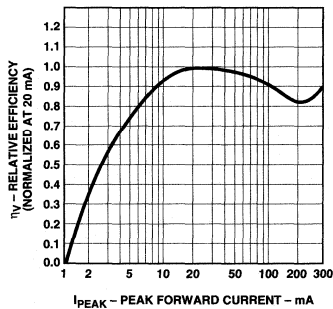

Figure 5. Relative Efficiency vs. Peak Forward Current.

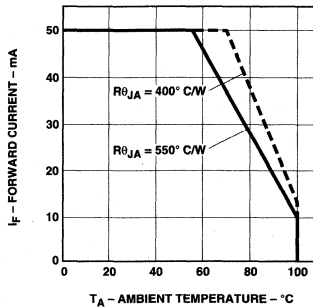

Figure 6. Maximum Forward DC Current vs. Ambient Temperature. Derating Based on  $T_{jMAX} = 110^\circ\text{C}$ .

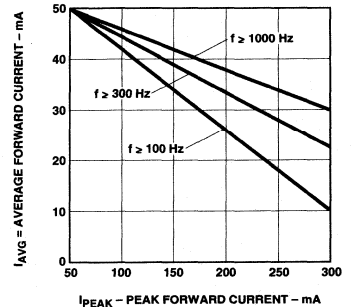

Figure 7. Maximum Average Current vs. Peak Forward Current.

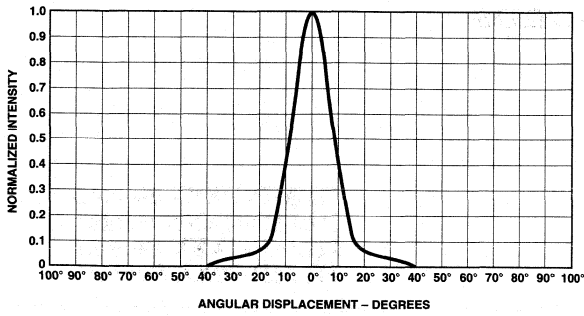

Figure 8. HLMP-Q106/-Q156.

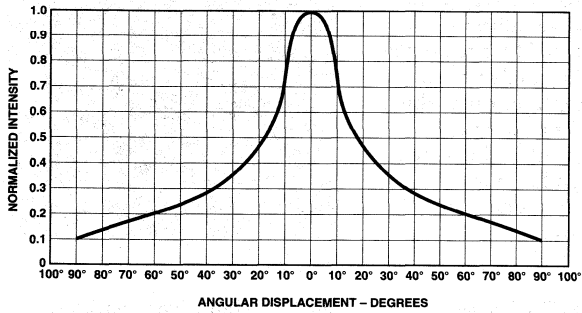

Figure 9. HLMP-Q102/-Q152

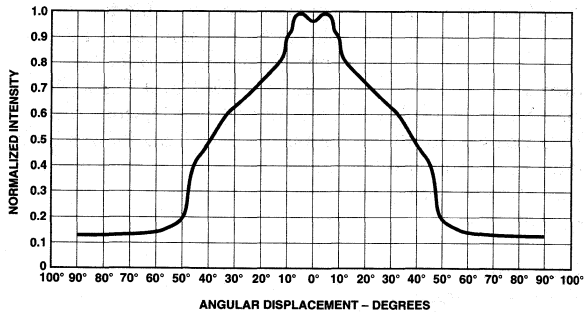

Figure 10. HLMP-P106/-P156.

---

# Subminiature LED Lamps

## Technical Data

---

**HLMP-PXXX Series**  
**HLMP-QXXX Series**  
**HLMP-6XXX Series**  
**HLMP-70XX Series**

---

### Features

- **Subminiature Flat Top Package**  
Ideal for Backlighting and Light Piping Applications
- **Subminiature Dome Package**  
Diffused Dome for Wide Viewing Angle  
Nondiffused Dome for High Brightness
- **Arrays**
- **TTL and LSTTL Compatible 5 Volt Resistor Lamps**
- **Available in Six Colors**
- **Ideal for Space Limited Applications**
- **Axial Leads**
- **Available with Lead Configurations for Surface Mount and Through Hole PC Board Mounting**

### Description

#### Flat Top Package

The HLMP-PXXX Series flat top lamps use an untinted, non-diffused, truncated lens to provide a wide radiation pattern that is necessary for use in backlighting applications. The flat top lamps are also ideal for use as emitters in light pipe applications.

#### Dome Packages

The HLMP-6XXX Series dome lamps for use as indicators use a tinted, diffused lens to provide a wide viewing angle with a high on-off contrast ratio. High brightness lamps use an untinted, nondiffused lens to provide a high luminous intensity within a narrow radiation pattern.

#### Arrays

The HLMP-66XX Series subminiature lamp arrays are available in lengths of 3 to 8 elements per array. The luminous intensity is matched within an array to assure a 2.1 to 1.0 ratio.

#### Resistor Lamps

The HLMP-6XXX Series 5 volt subminiature lamps with built in current limiting resistors are for use in applications where space is at a premium.

#### Lead Configurations

All of these devices are made by encapsulating LED chips on axial lead frames to form molded epoxy subminiature lamp packages. A variety of package configuration options is available. These include special

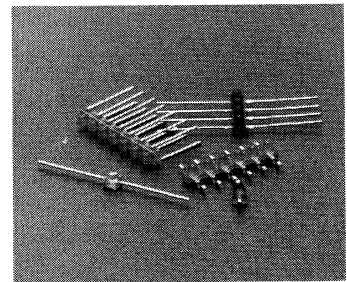

surface mount lead configurations, gull wing, yoke lead or Z-bend. Right angle lead bends at 2.54 mm (0.100 inch) and 5.08 mm (0.200 inch) center spacing are available for through hole mounting. For more information refer to Standard SMT and Through Hole Lead Bend Options for Subminiature LED Lamps data sheet.

## Device Selection Guide

### Part Number: HLMP-XXXX

Standard Red	DH AS AlGaAs Red	High Efficiency Red	Orange	Yellow	High Perf. Green	Emerald Green	Device Description <sup>[1]</sup>	Device Outline Drawing
	P105	P205	P405	P305	P505	P605	Untinted, Nondiffused, Flat Top	A
	P102	P202	P402	P302	P502		Untinted, Diffused, Flat Top	B
6000/6001	Q101	6300	Q400	6400	6500	Q600	Tinted, Diffused	
	Q105	6305		6405	6505		Untinted, Nondiffused, High Brightness	
	Q150	7000		7019	7040		Tinted, Diffused, Low Current	B
	Q155						Nondiffused, Low Current	
		6600		6700	6800		Tinted, Diffused, Resistor, 5 V, 10 mA	
		6620		6720	6820		Diffused, Resistor, 5 V, 4 mA	
6203		6653		6753	6853		3 Element Matched Array, Tinted, Diffused	
6204		6654		6754	6854	4 Element		
6205		6655		6755	6855	5 Element		
6206		6656		6756	6856	6 Element		
6208		6658		6758	6858	8 Element		

## Package Dimensions

### (A) Flat Top Lamps

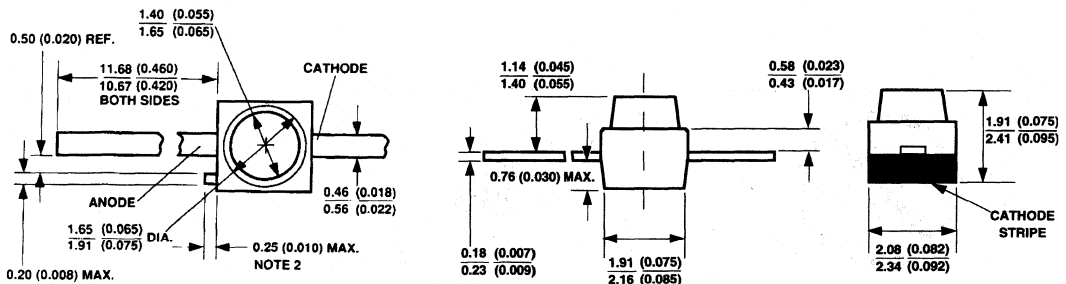

- NOTES:  
 1. ALL DIMENSIONS ARE IN MILLIMETERS (INCHES).  
 2. PROTRUDING SUPPORT TAB IS CONNECTED TO CATHODE LEAD.

\*Refer to Figure 1 for design concerns.

## Package Dimensions (cont.)

### (B) Diffused and Nondiffused

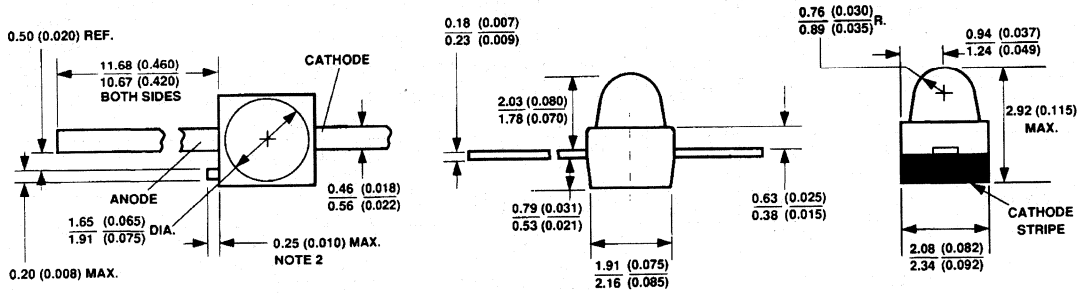

#### NOTES:

1. ALL DIMENSIONS ARE IN MILLIMETERS (INCHES).
2. PROTRUDING SUPPORT TAB IS CONNECTED TO CATHODE LEAD.

\*Refer to Figure 1 for design concerns.

### (C) Arrays

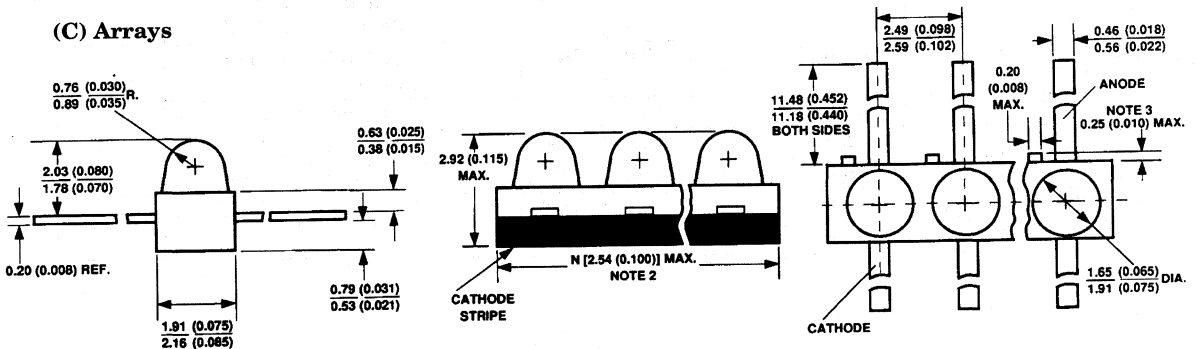

#### NOTES:

1. ALL DIMENSIONS ARE IN MILLIMETERS (INCHES).
2. PROTRUDING SUPPORT TAB IS CONNECTED TO CATHODE LEAD.

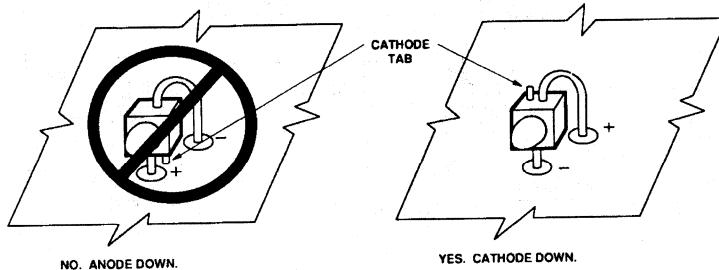

Figure 1. Proper Right Angle Mounting to a PC Board to Prevent Protruding Cathode Tab from Shorting to Anode Connection.

### Absolute Maximum Ratings at $T_A = 25^\circ\text{C}$

Parameter	Standard Red	DH AS AlGaAs Red	High Eff. Red	Orange	Yellow	High Perf. Green	Emerald Green	Units
DC Forward Current <sup>[1]</sup>	50	30	30	30	20	30	30	mA
Peak Forward Current <sup>[2]</sup>	1000	300	90	90	60	90	90	mA
DC Forward Voltage (Resistor Lamps Only)			6		6	6	6	V
Reverse Voltage ( $I_R = 100 \mu\text{A}$ )	5	5	5	5	5	5	5	V
Transient Forward Current <sup>[3]</sup> (10 $\mu\text{s}$ Pulse)	2000	500	500	500	500	500	500	mA
Operating Temperature Range: Non-Resistor Lamps	-55 to +100	-40 to +100	-55 to +100			-40 to +100	-20 to +100	°C
Resistor Lamps			-40 to +85			-20 to +85		
Storage Temperature Range	-55 to +100							°C
For Thru Hole Devices Wave Soldering Temperature [1.6 mm (0.063 in.) from body]	260°C for 5 Seconds							
For Surface Mount Devices: Convective IR	235°C for 90 Seconds							
Vapor Phase	215°C for 3 Minutes							

#### Notes:

1. See Figure 5 for current derating vs. ambient temperature. Derating is not applicable to resistor lamps.
2. Refer to Figure 6 showing Max. Tolerable Peak Current vs. Pulse Duration to establish pulsed operating conditions.
3. The transient peak current is the maximum non-recurring peak current the device can withstand without failure. Do not operate these lamps at this high current.

## Electrical/Optical Characteristics, $T_A = 25^\circ\text{C}$

### Standard Red

Device HLMP-	Parameter	Symbol	Min.	Typ.	Max.	Units	Test Conditions
6000	Luminous Intensity <sup>[1]</sup>	$I_v$	0.5	1.2		mcd	$I_F = 10 \text{ mA}$
6001			1.3	3.2			
6203 to 6208			0.5	1.2			
All	Forward Voltage	$V_F$	1.4	1.6	2.0	V	$I_F = 10 \text{ mA}$
	Reverse Breakdown Voltage	$V_R$	5.0	12.0		V	$I_R = 100 \mu\text{A}$
P005	Included Angle Between Half Intensity Points <sup>[2]</sup>	$2\theta_{1/2}$		125		Deg.	
All Others				90			
All	Peak Wavelength	$\lambda_{\text{PEAK}}$		655		nm	
	Dominant Wavelength <sup>[3]</sup>	$\lambda_d$		640		nm	
	Spectral Line Half Width	$\Delta\lambda_{1/2}$		24		nm	
	Speed of Response	$\tau_s$		15		ns	
	Capacitance	C		100		pF	$V_F = 0; f = 1 \text{ MHz}$
	Thermal Resistance	$R\theta_{J-PIN}$		170		$^\circ\text{C/W}$	Junction-to-Cathode Lead
	Luminous Efficacy <sup>[4]</sup>	$\eta_v$		65		lm/W	



## DH AS AlGaAs Red

Device HLMP-	Parameter	Symbol	Min.	Typ.	Max.	Units	Test Conditions
P102	Luminous Intensity	$I_v$	4.0	20.0		med	$I_F = 20 \text{ mA}$
P105			8.6	30.0			
Q101			22.0	45.0			
Q105			22.0	55.0			$I_F = 1 \text{ mA}$
Q150			1.0	1.8			
Q155			2.0	4.0			
Q101	Forward Voltage	$V_F$		1.8	2.2	V	$I_F = 20 \text{ mA}$
P205/P505 Q101/Q105				1.8	2.2		$I_F = 1 \text{ mA}$
Q150/Q155				1.6	1.8		
All	Reverse Breakdown Voltage	$V_R$	5.0	15.0		V	$I_R = 100 \mu\text{A}$
P105	Included Angle Between Half Intensity Points <sup>[2]</sup>	$2\theta^{1/2}$		125		Deg.	
Q101/Q150				90			
Q105/Q155				28			
All	Peak Wavelength	$\lambda_{\text{PEAK}}$		645		nm	Measured at Peak
	Dominant Wavelength <sup>[3]</sup>	$\lambda_d$		637		nm	
	Spectral Line Half Width	$\Delta\lambda_{1/2}$		20		nm	
	Speed of Response	$\tau_s$		30		ns	Exponential Time Constant; $e^{-t/\tau_s}$
	Capacitance	C		30		pF	$V_F = 0$ ; $f = 1 \text{ MHz}$
	Thermal Resistance	$R\theta_{\text{J-PIN}}$		170		$^{\circ}\text{C/W}$	Junction-to Cathode Lead
	Luminous Efficacy <sup>[4]</sup>	$\eta_v$		80		$\text{lm/W}$	

### High Efficiency Red

Device HLMP-	Parameter	Symbol	Min.	Typ.	Max.	Units	Test Conditions
P202	Luminous Intensity <sup>[1]</sup>	$I_v$	1.0	5.0		mcd	$I_F = 10 \text{ mA}$
P205			1.0	8.0			
6300			1.0	10.0			
6305			3.4	24.0			
7000			0.4	1.0			$I_F = 2 \text{ mA}$
6600			1.3	5.0			$V_F = 5.0 \text{ Volts}$
6620			0.8	2.0			
6653 to 6658			1.0	3.0			$I_F = 10 \text{ mA}$
All	Forward Voltage (Nonresistor Lamps)	$V_F$	1.5	1.8	3.0	V	$I_F = 10 \text{ mA}$
6600	Forward Current (Resistor Lamps)	$I_F$		9.6	13.0	mA	$V_F = 5.0 \text{ V}$
6620				3.5	5.0		
All	Reverse Breakdown Voltage	$V_R$	5.0	30.0		V	$I_R = 100 \mu\text{A}$
P205	Included Angle Between Half Intensity Points <sup>[2]</sup>	$2\theta_{1/2}$		125		Deg.	
6305				28			
All Diffused				90			
All	Peak Wavelength	$\lambda_{\text{PEAK}}$		635		nm	Measured at Peak
	Dominant Wavelength <sup>[3]</sup>	$\lambda_d$		626		nm	
	Spectral Line Half Width	$\Delta\lambda_{1/2}$		40		nm	
	Speed of Response	$\tau_s$		90		ns	
	Capacitance	C		11		pF	$V_F = 0; f = 1 \text{ MHz}$
	Thermal Resistance	$R\theta_{\text{J-PIN}}$		170		$^{\circ}\text{C/W}$	Junction-to-Cathode Lead
	Luminous Efficacy <sup>[4]</sup>	$\eta_v$		145		lm/W	

**Orange**

Device HLMP-	Parameter	Symbol	Min.	Typ.	Max.	Units	Test Conditions
P402	Luminous Intensity	$I_v$	1.0	4.0		mcd	$I_F = 10 \text{ mA}$
P405			1.0	6			
Q400			1.0	8			
All	Forward Voltage	$V_F$	1.5	1.9	3.0	V	$I_F = 10 \text{ mA}$
	Reverse Breakdown Voltage	$V_R$	5.0	30.0		V	$I_R = 100 \mu\text{A}$
P405	Included Angle Between Half Intensity Points <sup>[2]</sup>	$2\theta^{1/2}$		125		Deg.	
Q400				90			
All	Peak Wavelength	$\lambda_{\text{PEAK}}$		600		nm	
	Dominant Wavelength <sup>[3]</sup>	$\lambda_d$		602		nm	Measured at Peak
	Spectral Line Half Width	$\Delta\lambda_{1/2}$		40		nm	
	Speed of Response	$\tau_s$		260		ns	
	Capacitance	C		4		pF	$V_F = 0; f = 1 \text{ MHz}$
	Thermal Resistance	$R\theta_{\text{J-PIN}}$		170		°C/W	Junction-to-Cathode Lead
	Luminous Efficacy <sup>[4]</sup>	$\eta_v$		380		lm/W	

**Yellow**

Device HLMP-	Parameter	Symbol	Min.	Typ.	Max.	Units	Test Conditions
P302	Luminous Intensity <sup>[1]</sup>	$I_v$	1.0	3.0		mcd	$I_F = 10 \text{ mA}$
P305			1.0	4.0			
6400			1.0	9.0			
6405			3.6	20			
7019			0.4	0.6			$I_F = 2 \text{ mA}$
6700			1.4	5.0			$V_F = 5.0 \text{ Volts}$
6720			0.9	2.0			
6753 to 6758			1.0	3.0			$I_F = 10 \text{ mA}$
All	Forward Voltage (Nonresistor Lamps)	$V_F$		2.0	2.4	V	$I_F = 10 \text{ mA}$
6700	Forward Current (Resistor Lamps)	$I_F$		9.6	13.0	mA	$V_F = 5.0 \text{ V}$
6720				3.5	5.0		
All	Reverse Breakdown Voltage	$V_R$	5.0	50.0		V	
P305	Included Angle Between Half Intensity Points <sup>[2]</sup>	$2\theta_{1/2}$		125		Deg.	
6405				28			
All Diffused				90			
All	Peak Wavelength	$\lambda_{PEAK}$		583		nm	Measured at Peak
	Dominant Wavelength <sup>[3]</sup>	$\lambda_d$		585		nm	
	Spectral Line Half Width	$\Delta\lambda_{1/2}$		36		nm	
	Speed of Response	$\tau_s$		90		ns	
	Capacitance	C		15		pF	$V_F = 0; f = 1 \text{ MHz}$
	Thermal Resistance	$R\theta_{J-PIN}$		170		°C/W	Junction-to-Cathode Lead
	Luminous Efficacy <sup>[4]</sup>	$\eta_v$		500		lm/W	

### High Performance Green

Device HLMP-	Parameter	Symbol	Min.	Typ.	Max.	Units	Test Conditions
P502	Luminous Intensity <sup>[1]</sup>	$I_v$	1.0	3.0		mcd	$I_F = 10 \text{ mA}$
P505			1.0	5.0			
6500			1.0	7.0			
6505			4.2	20.0			
7040			0.4	0.6			$I_F = 2 \text{ mA}$
6800			1.6	5.0			$V_F = 5.0 \text{ Volts}$
6820			0.8	2.0			
6853 to 6858			1.0	3.0			$I_F = 10 \text{ mA}$
All	Forward Voltage (Nonresistor Lamps)	$V_F$		2.1	2.7	V	$I_F = 10 \text{ mA}$
6800	Forward Current (Resistor Lamps)	$I_F$		9.6	13.0	mA	$V_F = 5.0 \text{ V}$
6820				3.5	5.0		
All	Reverse Breakdown Voltage	$V_R$	5.0	50.0		V	$I_R = 100 \mu\text{A}$
P505	Included Angle Between Half Intensity Points <sup>[2]</sup>	$2\theta^{1/2}$		125		Deg.	
6505				28			
All Diffused				90			
All	Peak Wavelength	$\lambda_{\text{PEAK}}$		565		nm	
	Dominant Wavelength <sup>[3]</sup>	$\lambda_d$		569		nm	
	Spectral Line Half Width	$\Delta\lambda_{1/2}$		28		nm	
	Speed of Response	$\tau_s$		500		ns	
	Capacitance	C		18		pF	$V_F = 0; f = 1 \text{ MHz}$
	Thermal Resistance	$R\theta_{\text{J-PIN}}$		170		°C/W	Junction-to-Cathode Lead
	Luminous Efficacy <sup>[4]</sup>	$\eta_v$		595		lm/W	

**Notes:**

1. The luminous intensity for arrays is tested to assure a 2.1 to 1.0 matching between elements. The average luminous intensity for an array determines its light output category bin. Arrays are binned for luminous intensity to allow  $I_v$  matching between arrays.
2.  $\theta^{1/2}$  is the off-axis angle where the luminous intensity is half the on-axis value.
3. Dominant wavelength,  $\lambda_d$ , is derived from the CIE Chromaticity Diagram and represents the single wavelength that defines the color of the device.
4. Radiant intensity,  $I_e$ , in watts/steradian, may be calculated from the equation  $I_e = I_v / \eta_v$ , where  $I_v$  is the luminous intensity in candelas and  $\eta_v$  is the luminous efficacy in lumens/watt.

### **Emerald Green<sup>[1]</sup>**

<b>Device HLMP-</b>	<b>Parameter</b>	<b>Symbol</b>	<b>Min.</b>	<b>Typ.</b>	<b>Max.</b>	<b>Units</b>	<b>Test Conditions</b>
P605	Luminous Intensity	$I_v$	1.0	1.5		mcd	$I_F = 10 \text{ mA}$
Q600			1.0	1.5			
	Forward Voltage	$V_F$		2.2	3.0	V	$I_F = 10 \text{ mA}$
	Reverse Breakdown Voltage	$V_R$	5.0			V	$I_R = 100 \mu\text{A}$
P605	Included Angle Between Half Intensity Points <sup>[2]</sup>	$2\theta^{1/2}$		125		Deg.	
Q600				90			
P605/ Q600	Peak Wavelength	$\lambda_{\text{PEAK}}$		558		nm	
	Dominant Wavelength <sup>[3]</sup>	$\lambda_d$		560		nm	Measured at Peak
	Spectral Line Half Width	$\Delta\lambda_{1/2}$		24		nm	
	Speed of Response	$\tau_s$		3100		ns	
	Capacitance	C		35		pF	$V_F = 0; f = 1 \text{ MHz}$
	Thermal Resistance	$R\theta_{\text{J-PIN}}$		170		$^{\circ}\text{C/W}$	Junction-to-Cathode Lead
	Luminous Efficacy <sup>[4]</sup>	$\eta_v$		656		lm/W	

**Note:**

1. Please refer to Application Note 1061 for information comparing standard green and emerald green light output degradation.

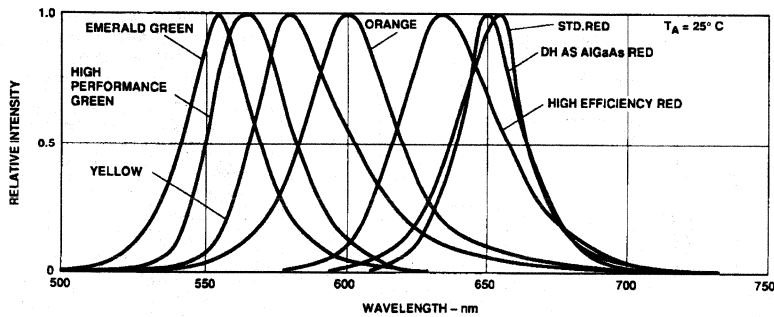

Figure 1. Relative Intensity vs. Wavelength.

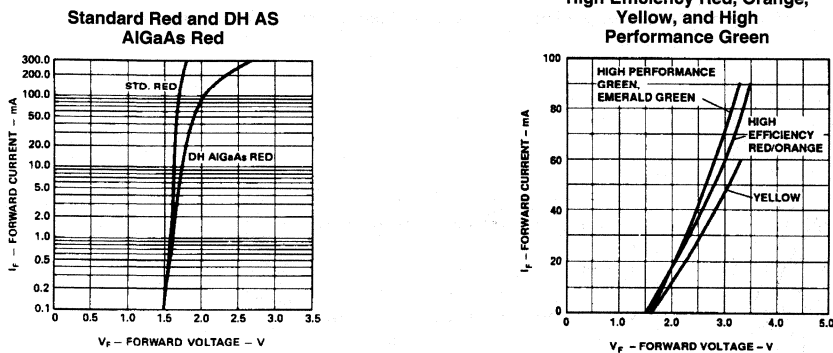

Figure 2. Forward Current vs. Forward Voltage. (Non-Resistor Lamp)

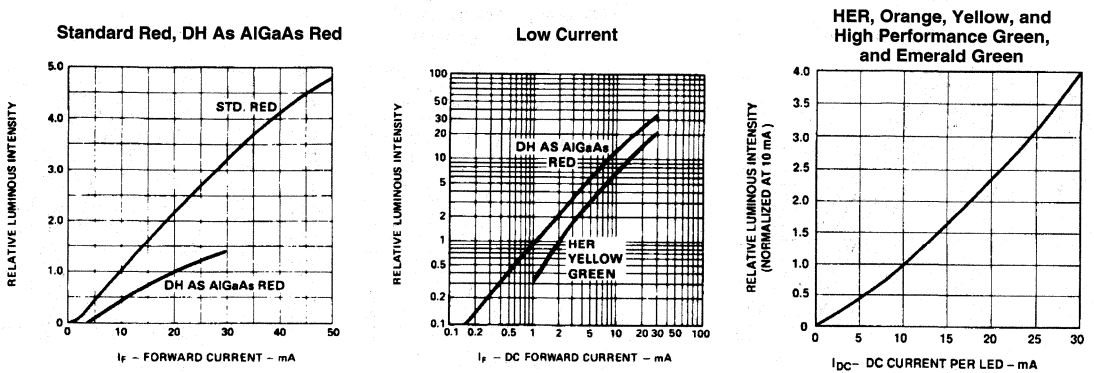

Figure 3. Relative Luminous Intensity vs. Forward Current. (Non-Resistor Lamp)

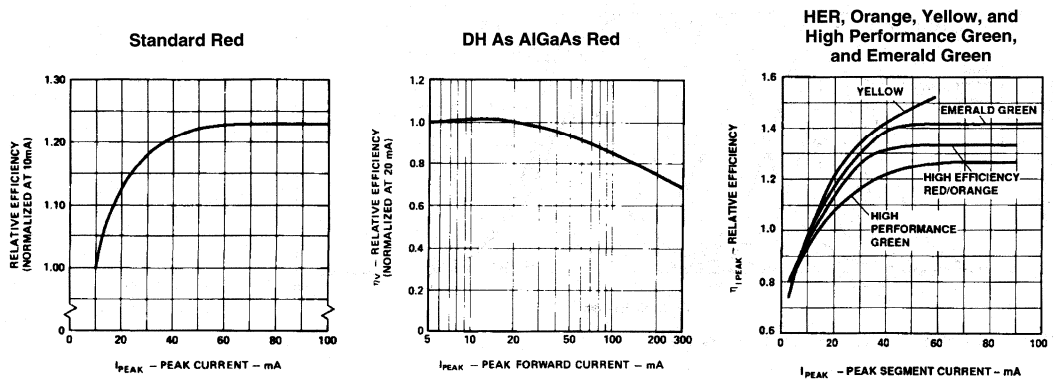

Figure 4. Relative Efficiency (Luminous Intensity per Unit Current) vs. Peak Current (Non-Resistor Lamps).

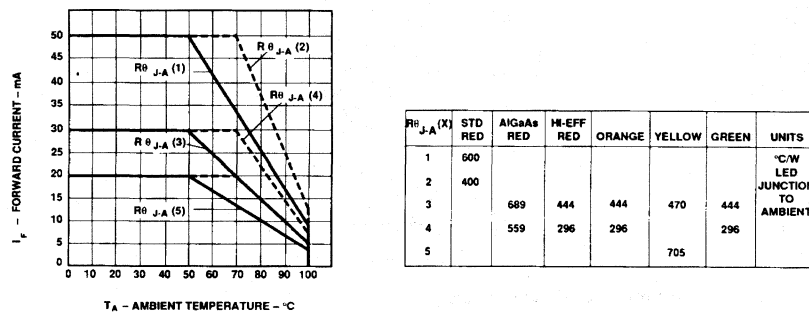

Figure 5. Maximum Forward dc Current vs. Ambient Temperature. Derating Based on  $T_j$  MAX = 110 °C (Non-Resistor Lamps).

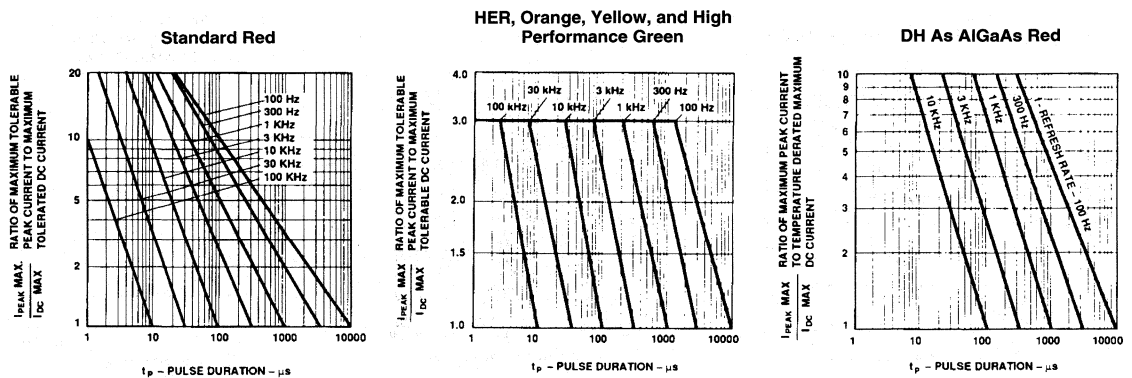

Figure 6. Maximum Tolerable Peak Current vs. Pulse Duration. ( $I_{DC}$  MAX as per MAX Ratings) (Non-Resistor Lamps).



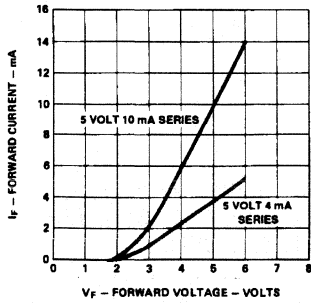

Figure 7. Resistor Lamp Forward Current vs. Forward Voltage.

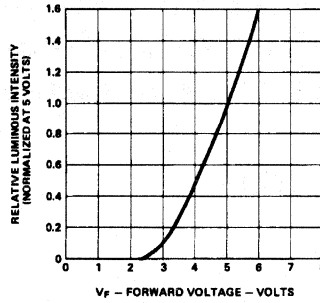

Figure 8. Resistor Lamp Luminous Intensity vs. Forward Voltage.

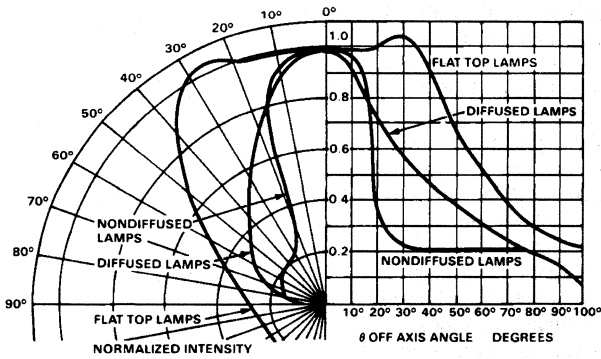

Figure 9. Relative Intensity vs. Angular Displacement.

---

# Standard SMT and Through Hole Lead Bend Options for Subminiature LED Lamps

## Technical Data

**Option 011, 012, 013,  
021, 022, 031, 032, 1L1,  
1S1, 2L1, 2S1**

---

### Features

- **Surface Mount Lead Configurations**
- **Right Angle Lead Bend for Through Hole Mounting**
- **Tape and Reel in Accordance with ANSI/EIA RS-481 Specifications**

### Description

Subminiature lamps (HLMP-PXXX, HLMP-Q1XX, HLMP-6XXX, HLMP-70XX) are available with the above standard options. Subminiature Lamps with Options 01X, 02X and 03X are suitable for surface mount applications and their leads are formed with gull wing, yoke bend and Z bend respectively. They are available in Tape and Reel (compatible to ANSI/EIA RS-481), bulk or arrays in a shipping tube. Option 1X1 and 2X1 are right angle lead bends suitable for through hole applications.

### Ordering Information

To order Subminiature Lamps packaged with these standard options, include the appropriate option code along with the device catalog part number. Example: to order the HLMP-P005 with Option 011 gull wing leads in 12 mm embossed tape on 178 mm (7 inch) diameter reels, with 1500 lamps per reel; order as follows: HLMP-P005 Option 011. Order quantities must be placed in reel increments only. Orders for partial reels will not be accepted. For additional information, please contact your local Hewlett-Packard sales office or franchised distributor for assistance.

## Selection Guide

Option Code	Package Configuration		Package Outline Drawing
011	Gull Wing Leads, 12 mm Tape on 7 in. Dia. Reel, 1500 Parts per Reel <sup>[1]</sup>		Surface Mount Lead Configurations
012	Gull Wing Lead, Bulk Packaging, Quantity of 500 Parts <sup>[3]</sup>		
013	Gull Wing Leads, Arrays, Shipping Tube, Quantity see Figure J		
014	Gull Wing Leads, 12 mm Tape on 13 in. Dia. Reel, 6000 Parts per Reel <sup>[1]</sup>		
021	Yoke Leads, 12 mm Tape on 7 in. Dia. Reel 1500 Parts per Reel <sup>[1]</sup>		
022	Yoke Leads, Bulk Packaging, Quantity of 500 Parts <sup>[2]</sup>		
024	Yoke Leads, 12 mm Tape on 13 in. Dia. Reel, 6000 Parts per Reel <sup>[1]</sup>		
031	Z-Bend Leads, 12 mm Tape on 7 in. Dia. Reel 1500 Parts per Reel <sup>[1]</sup>		
032	Z-Bend Leads, Bulk Packaging, Quantity of 500 Parts <sup>[2]</sup>		
034	Z-Bend Leads, 12 mm Tape on 13 in. Dia. Reel, 6000 Parts per Reel <sup>[1]</sup>		
1L1	2.54 mm (0.100 inch)	Long Leads; 10.4 mm (0.410 in.)	Right Angle Lead Bends for Through Hole Mounting
1S1	Center Lead Spacing	Short Leads; 3.7 mm (0.145 in.)	
2L1	5.08 mm (0.200 inch)	Long Leads; 9.2 mm (0.364 in.)	
2S1	Center Lead Spacing	Short Leads; 3.7 mm (0.145 in.)	

**Notes:**

- SMT lamps are supplied in 12 mm embossed carrier tape. Minimum order is for one full reel, either 7 inch or 13 inch. All other order quantities must be in reel increments only. Orders for partial reels are not accepted.
- Vapor barrier bags are used for bulk packaging.

## Package Dimensions, Lead Bend Options

### (A) Individual Lamp, Gull Wing Lead, Option 011, 012, and 014

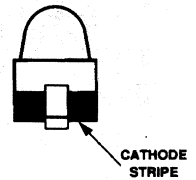
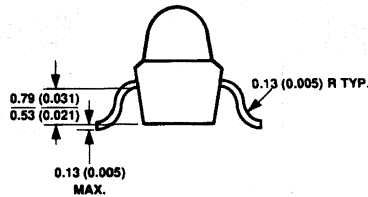
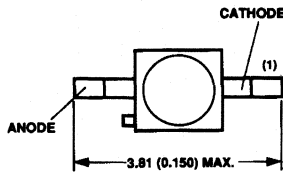

ALL DIMENSIONS ARE IN MILLIMETRES (INCHES)

**(B) Subminiature Array, Gull Wing Lead, Option 013**

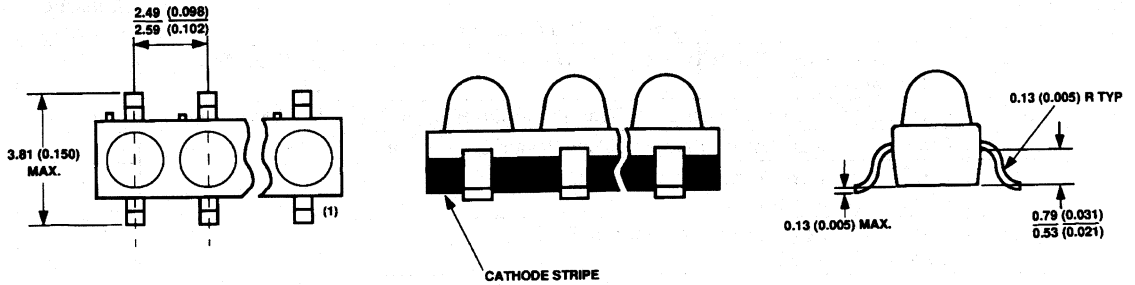

ALL DIMENSIONS ARE IN MILLIMETRES (INCHES)

(1) DUE TO SHEARING PROCESS, LEAD WIDTH AT END MAY VARY 0.483 mm/0.663 mm.

**(C) Individual Lamp, "Yoke" Lead, Options 021, 022, and 024**

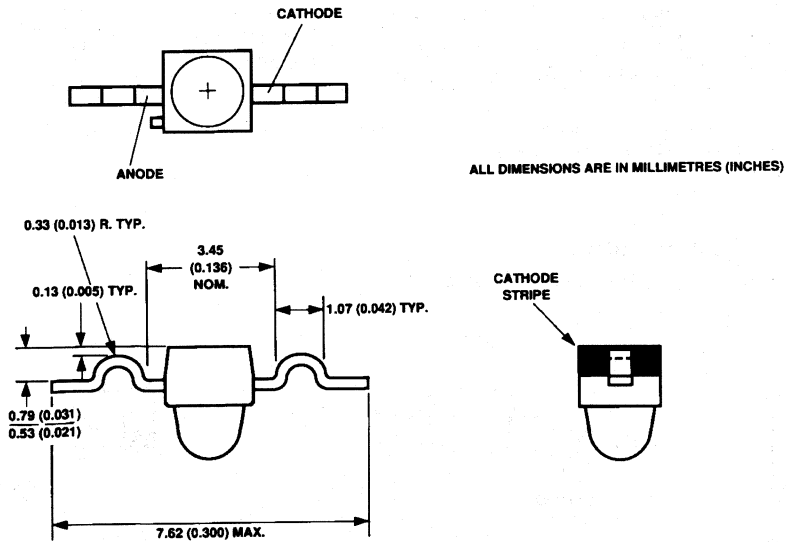

**(D) Individual Lamp, Z-Bend Lead, Option 031, 032, and 034**

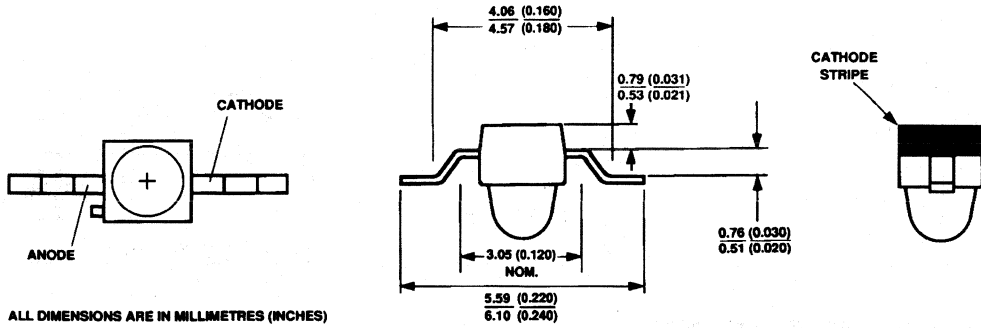

**(E) Individual Lamp or Array, Rt. Angle Bend Option 1L1**

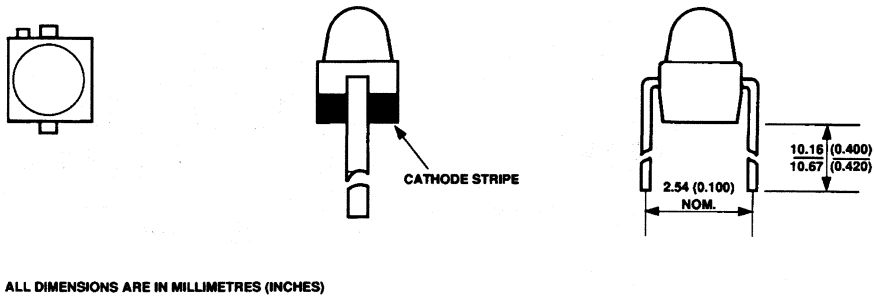

**(F) Individual Lamp or Array, Rt. Angle Bend Option 1S1**

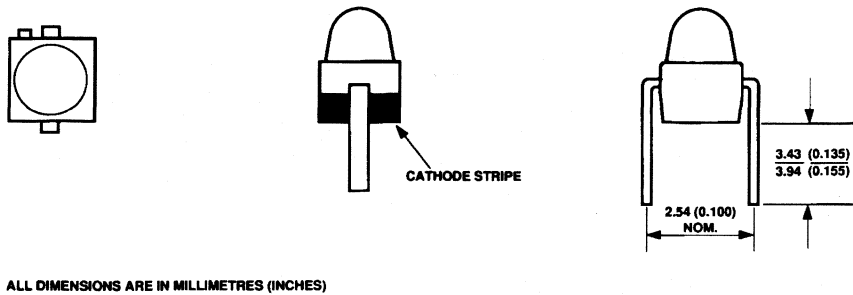

**(G) Individual Lamp or Array, Rt. Angle Bend Option 2L1**

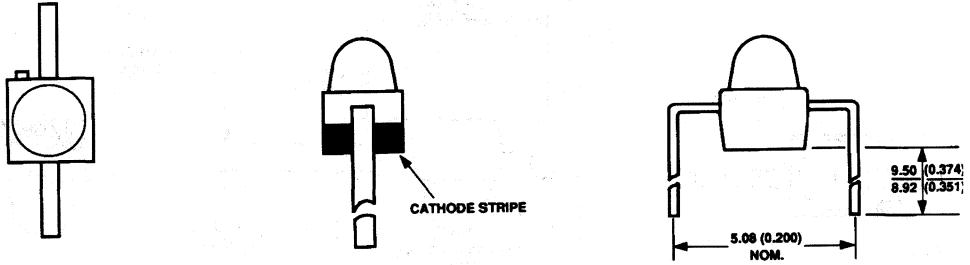

ALL DIMENSIONS ARE IN MILLIMETRES (INCHES)

**(H) Individual Lamp or Array, Rt. Angle Bend Option 2S1**

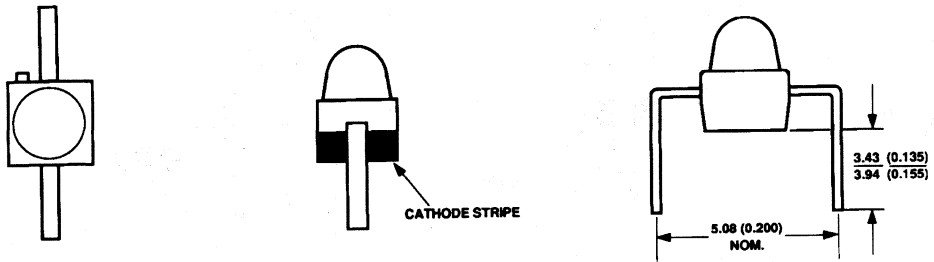

**Package Dimensions: Surface Mount Tape and Reel Options**

**(I) 12 mm Tape and Reel, Gull Wing Lead**

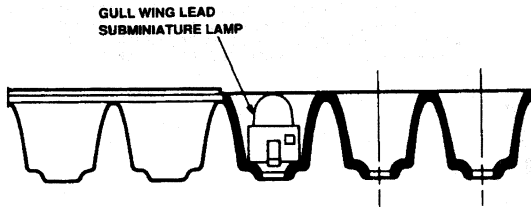
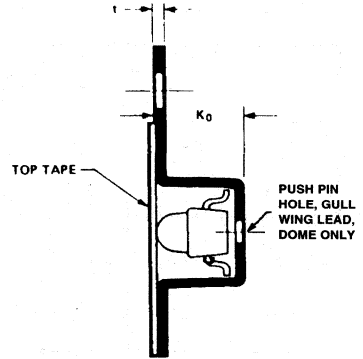
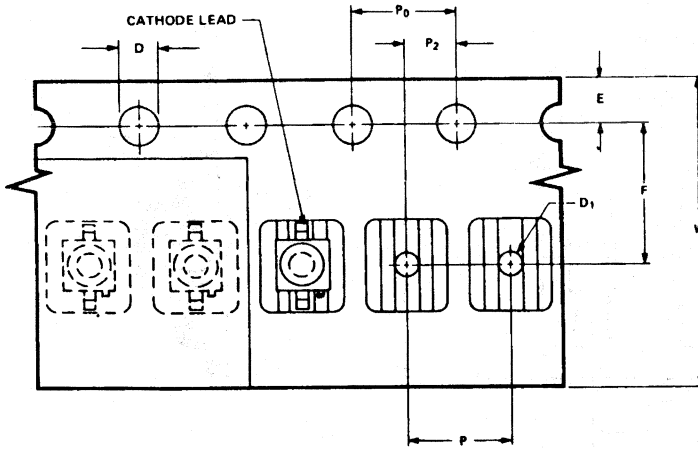

**NOTES:**

1. EMPTY COMPONENT POCKETS SEALED WITH TOP COVER TAPE.
2. MINIMUM LEADER LENGTH AT EITHER END OF THE TAPE IS 500 mm.
3. THE MAXIMUM NUMBER OF CONSECUTIVE MISSING LAMPS IS TWO.
4. IN ACCORDANCE WITH ANS/EIA RS-481 SPECIFICATIONS, THE CATHODE IS ORIENTED TOWARDS THE TAPE SPROCKET HOLE.

**(J) Array Shipping Tube, Gull Wing Lead**

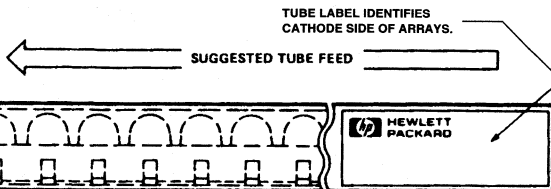
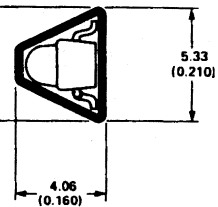
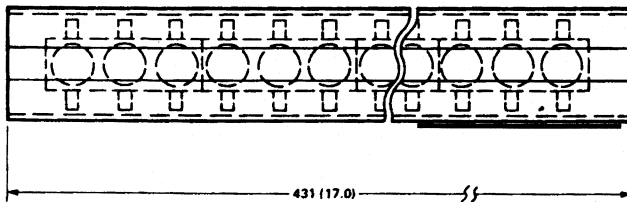

HLMP-	NO. OF LAMP ELEMENTS PER ARRAY	QUANTITY OF ARRAYS PER TUBE
6XX3	3	53
6XX4	4	40
6XX5	5	32
6XX6	6	26
6XX8	8	20

**(K) 12 mm Tape and Reel, "Yoke" Lead**

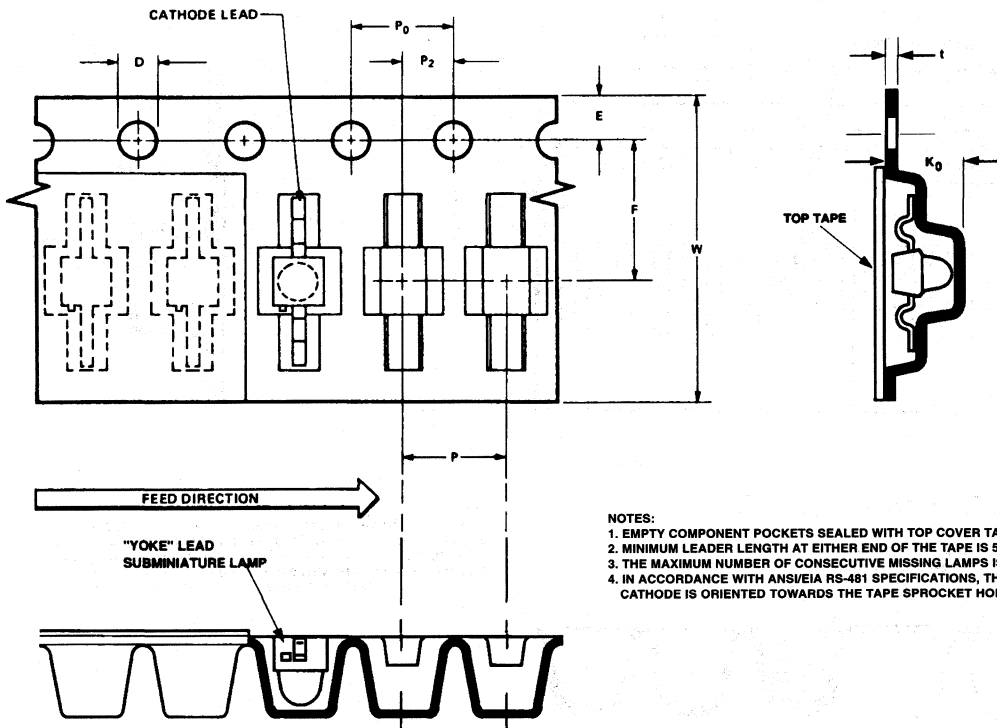

- NOTES:
1. EMPTY COMPONENT POCKETS SEALED WITH TOP COVER TAPE.
  2. MINIMUM LEADER LENGTH AT EITHER END OF THE TAPE IS 500 mm.
  3. THE MAXIMUM NUMBER OF CONSECUTIVE MISSING LAMPS IS TWO.
  4. IN ACCORDANCE WITH ANSIEIA RS-481 SPECIFICATIONS, THE CATHODE IS ORIENTED TOWARDS THE TAPE SPROCKET HOLE.



**(L) 12 mm Tape and Reel, Z-Bend Lead**

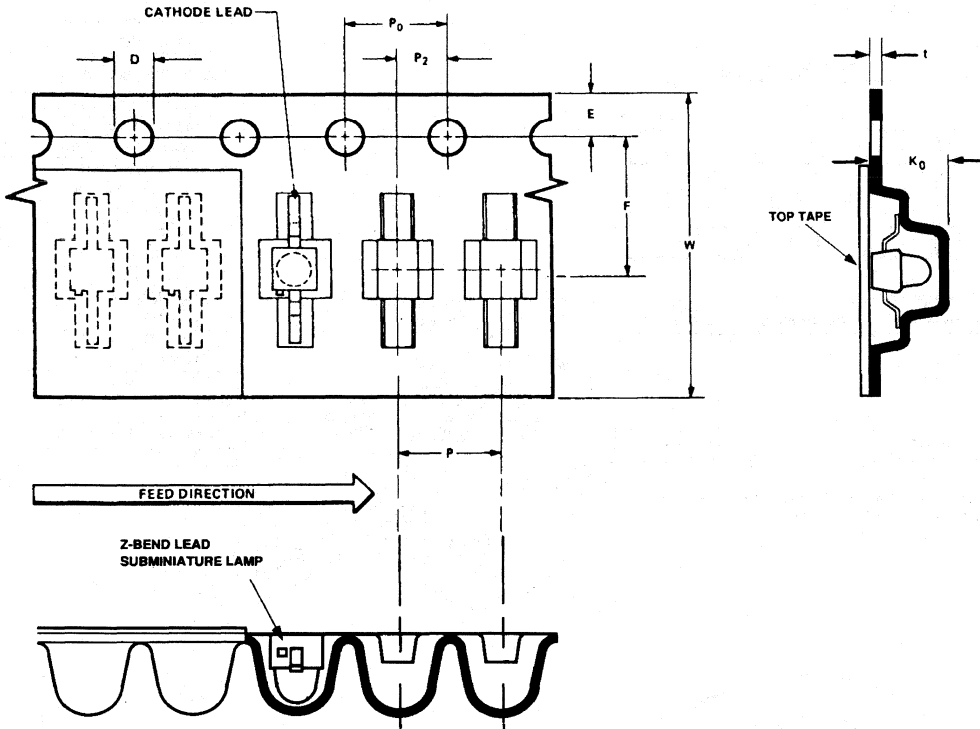

	Reel Dimensions Per ANSI/EIA Standard RS-481.	All Dimensions Are in Millimeters (Inches).
	7 inch Reel	13 Inch Reel
A	178.0 ± 2.0 (7.0 ± 0.08) Dia.	330 (12.9) Dia. Max.
C	13.0 (0.512) Dia. Typ.	13.0 (0.512) Dia. Typ.
N	50.0 (1.97) Min.	100.0 (3.93) Min.
T	18.4 (0.72) mMax.	18.4 (0.72) Max.

	Embossed Carrier Tape Dimensions Per ANSI/EIA Standard RS-481.	All Dimensions Are in Millimeters (Inches).			
	Gull Wing Dome	Gull Wing Flat Top	Yoke Dome	Z-Bend Dome	Yoke and Z-Bend Flat Top
D	1.55 (0.061 ± 0.002) Dia.	1.55 (0.061 ± 0.002) Dia.	1.55 (0.061 ± 0.002) Dia.	1.55 (0.061 ± 0.002) Dia.	1.55 (0.061 ± 0.002) Dia.
D <sub>1</sub>	1.0 (0.039) Dia. Min.	N/A (No Push Pin Hole)	N/A (No Push Pin Hole)	N/A (No Push Pin Hole)	N/A (No Push Pin Hole)
D <sub>2</sub>	20.2 (0.795) Dia. Min.	20.2 (0.795) Dia. Min.	20.2 (0.795) Dia. Min.	20.2 (0.795) Dia. Min.	20.2 (0.795) Dia. Min.
E	1.75 ± 0.1 (0.069)	1.75 ± 0.1 (0.069)	1.75 ± 0.1 (0.069)	1.75 ± 0.1 (0.069)	1.75 ± 0.1 (0.069)
F	3.23 (0.127 ± 0.002)	3.23 (0.127 ± 0.002)	3.23 (0.127 ± 0.002)	3.23 (0.127 ± 0.002)	3.23 (0.127 ± 0.002)
K <sub>0</sub>	3.05 ± 0.1 (0.120) Typ.	2.54 ± 0.1 (0.100) Typ.	3.05 ± 0.1 (0.120) Typ.	2.97 ± 0.1 (0.117) Typ.	3.05 ± 0.1 (0.120) Typ.
P	4.0 (0.157) Typ.	4.0 (0.157) Typ.	4.0 (0.157) Typ.	4.0 (0.157) Typ.	4.0 (0.157) Typ.
P <sub>0</sub>	4.0 (0.157) Typ.	4.0 (0.157) Typ.	4.0 (0.157) Typ.	4.0 (0.157) Typ.	4.0 (0.157) Typ.
P <sub>2</sub>	2.0 (0.079 ± 0.002)	2.0 (0.079 ± 0.002)	2.0 (0.079 ± 0.002)	2.0 (0.079 ± 0.002)	2.0 (0.079 ± 0.002)
t	0.3 (0.012) Typ.	0.3 (0.012) Typ.	0.3 (0.012) Typ.	0.3 (0.012) Typ.	0.3 (0.012) Typ.
W	12.0 ± 0.3 (0.472 ± 0.012)	12.0 ± 0.3 (0.472 ± 0.012)	12.0 ± 0.3 (0.472 ± 0.012)	12.0 ± 0.3 (0.472 ± 0.012)	12.0 ± 0.3 (0.472 ± 0.012)

**(M) 12 mm Tape and Reel**

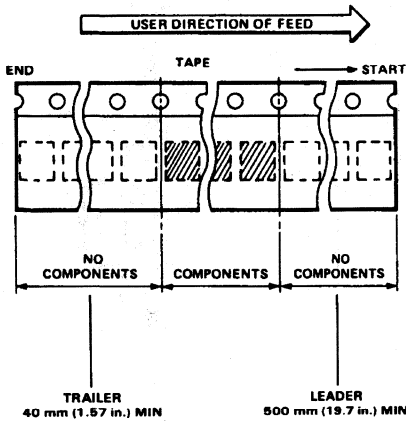

TOLERANCES (UNLESS OTHERWISE SPECIFIED):  
 .X ± .1; .XX ± .05 (.XXX ± .004)

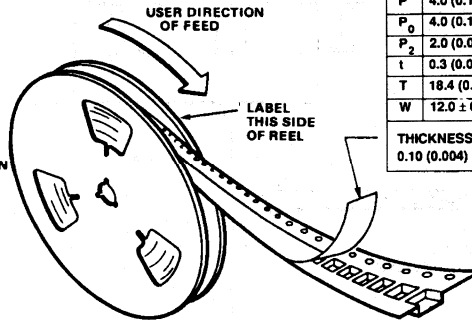

DIMENSIONS PER ANSI/EIA  
 STANDARD RS-481.  
 ALL DIMENSIONS ARE IN  
 MILLIMETRES (INCHES).

A	178.0 ± 2.0 (7.0 ± 0.08) DIA.
C	13.0 (0.512) DIA. TYP.
D	1.55 (0.061 ± 0.002) DIA.
D <sub>1</sub>	1.0 (0.039) DIA. MIN.
D <sub>2</sub>	20.2 (0.795) DIA. MIN.
E	1.75 ± 0.1 (0.069)
F	5.50 (0.127 ± 0.002)
K <sub>0</sub>	3.05 ± 0.1 (0.120) TYP.
N	50.0 (1.970) MIN.
P	4.0 (0.157) TYP.
P <sub>0</sub>	4.0 (0.157) TYP.
P <sub>2</sub>	2.0 (0.079 ± 0.002) TYP.
t	0.3 (0.012) TYP.
T	18.4 (0.72) MAX.
W	12.0 ± 0.3 (0.472 ± 0.012)

THICKNESS OF TOP COVER TAPE  
 0.10 (0.004) MAX.

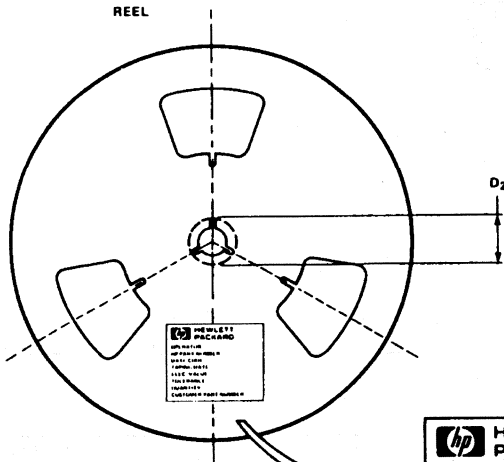

	<b>HEWLETT PACKARD</b>
OPERATOR	_____
HP PART NUMBER	_____
DATE CODE	_____
TAPING DATE	_____
ELEC. VALUE	_____
TOLERANCE	_____
QUANTITY	_____
CUSTOMER PART NUMBER	_____

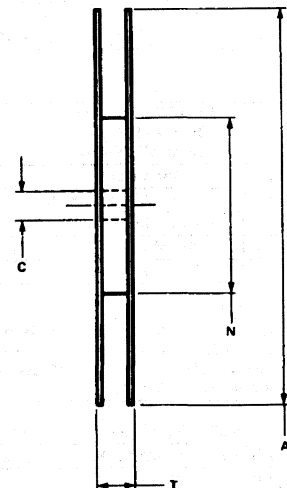

# Subminiature Right Angle LED Indicators

## Technical Data

### Option 010

#### Features

- Ideal for PC Board Status Indication
- Side Stackable on 2.54 mm (0.100 in.) Centers
- Available in Four Colors
- Housing Meets UL 94V-0 Flammability Rating
- Additional Catalog Lamps Available as Options

#### Description

The Hewlett-Packard series of Subminiature Right Angle Indicators are industry standard status indicators that incorporate tinted diffused LED lamps in black plastic housings. The 2.54 mm (0.100 in.) wide packages may be side stacked for maximum board space

savings. The silver plated leads are in line on 2.54 mm (0.100 in.) centers, a standard spacing that makes the PC board layout straight-forward. These products are designed to be used as back panel diagnostic indicators and logic status indicators on PC boards.

#### Package Dimensions

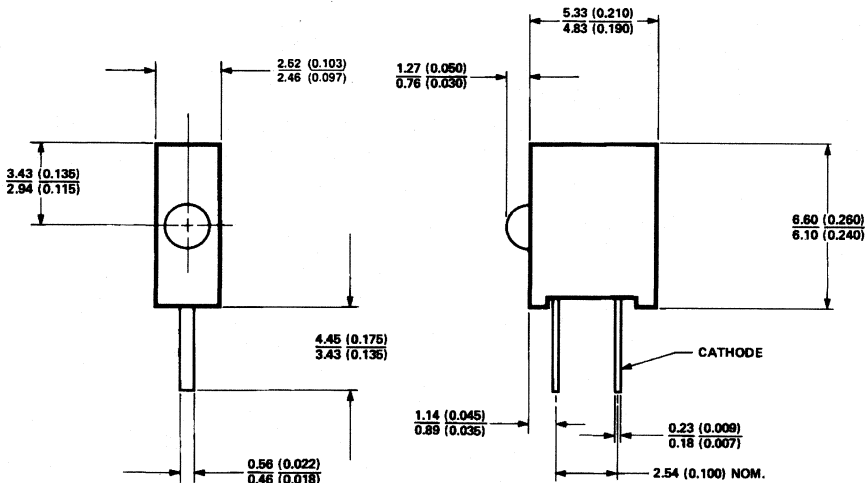

NOTE: ALL DIMENSIONS ARE IN MILLIMETRES (INCHES).

### **Ordering Information**

To order Subminiature Right Angle indicators, order the base part number and add the option code 010. Example: HLMP-6300 option 010. For price and delivery on Resistor Subminiature Right Angle Indicators and other subminiature LEDs not indicated above, please contact your nearest HP Components representative.

### **Absolute Maximum Ratings and Other Electrical/Optical Characteristics**

The absolute maximum ratings and typical device characteristics are identical to those of the Subminiature lamps. For information about these characteristics, see the data sheets of the equivalent Subminiature lamp.

# Surface Mount High Performance AlInGaP LED Indicators

## Technical Data

**SunPower Series**  
**HSMA-TX25**  
**HSMD-TX25**  
**HSMJ-TX25**

### Features

- **Outstanding LED Material Efficiency**
- **Exceptional Light Output Over a Wide Range of Drive Currents**
- **Colors: 590 nm Amber, 603 nm Orange, and 615 nm Reddish-Orange**
- **Compatible with Automatic Placement Equipment**
- **Compatible with Convective IR, Vapor Phase Reflow, and TTW Solder Processes**
- **Packaged in 12 mm or 8 mm Tape on 7" or 13" Diameter Reels**
- **EIA Standard Package**
- **Low Package Profile**
- **Non-diffused Package Excellent for Backlighting and Coupling to Light Pipes**

### Description

The LED material used in these devices is the very efficient absorbing Substrate aluminum indium gallium phosphide (AS AlInGaP), capable of producing high light output over a wide range of drive currents.

These solid state surface mount indicators are designed with a flat top and sides to be easily handled by automatic placement equipment. A glue pad is provided for adhesive mounting processes. They are compatible with convective IR and vapor phase reflow soldering, through the wave (TTW) soldering, and conductive epoxy attachment processes.

The package size and configuration conform to the EIA-535.

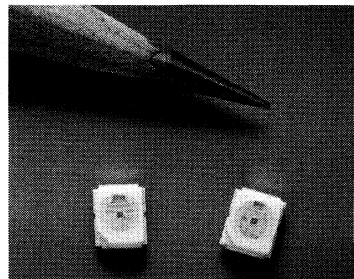

BAAC standard specification for case size 3528 tantalum capacitors. The folded leads permit dense placement and provide an external solder joint for ease of inspection.

These devices are non-diffused, providing high intensity for applications such as backlighting, light pipe illumination, and front panel indication.

### Device Selection Guide

Amber $\lambda_d = 590 \text{ nm}$	Orange $\lambda_d = 603 \text{ nm}$	Reddish-Orange $\lambda_d = 615 \text{ nm}$	Description
HSMA-T425	HSMD-T425	HSMJ-T425	12 mm Tape, 7" Reel, 2000 Devices
HSMA-T525	HSMD-T525	HSMJ-T525	12 mm Tape, 13" Reel, 8000 Devices
HSMA-T625	HSMD-T625	HSMJ-T625	8 mm Tape, 7" Reel, 2000 Devices
HSMA-T725	HSMD-T725	HSMJ-T725	8 mm Tape, 13" Reel, 8000 Devices

## Package Dimensions

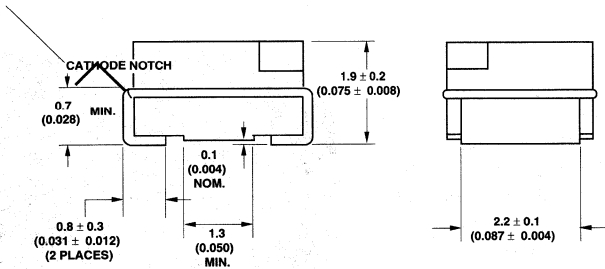
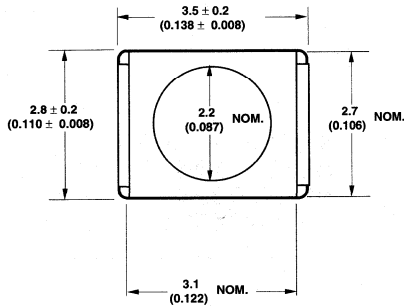

## Tape and Reel Specifications

Hewlett Packard surface mount LEDs are packaged tape and reel in accordance with EIA-481A, *Taping of Surface Mount*

*Components for Automatic Placement.* This packaging system is compatible with taped automatic pick and place systems. Each reel is sealed in a

vapor barrier bag for added protection. Bulk packaging in vapor barrier bags is available upon special request.

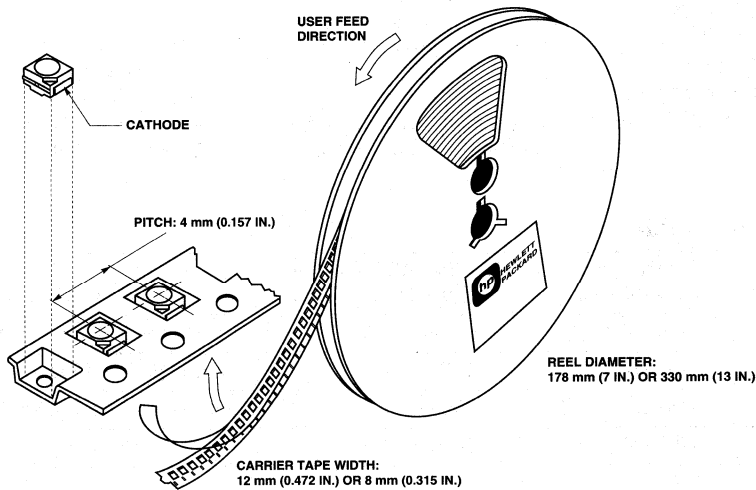

**Absolute Maximum Ratings at T<sub>A</sub> = 25°C**

DC Forward Current <sup>[1,4,5]</sup> .....	50 mA
Peak Forward Current <sup>[2]</sup> .....	200 mA
Average Forward Current .....	45 mA
(at I <sub>PEAK</sub> = 200 mA, f ≥ 1 KHz) <sup>[2]</sup>	
Transient Forward Current (10 μs Pulse) <sup>[3]</sup> .....	500 mA
Reverse Voltage (I <sub>R</sub> = 100 μA) .....	5 V
LED Junction Temperature .....	95°C
Operating Temperature Range .....	-40°C to +85°C
Storage Temperature Range .....	-40°C to +85°C
Reflow Soldering Temperatures	
Convective IR .....	235°C Peak, above 183°C for 90 seconds
Vapor Phase .....	215°C for 3 minutes

**Notes:**

1. Derate linearly as shown in Figure 4.
2. Refer to Figure 5 to establish pulsed operating conditions.
3. The transient peak current is the maximum non-recurring peak current the device can withstand without damaging the LED die and wire bonds.
4. Drive currents between 5 mA and 30 mA are recommended for best long term performance.
5. Operation at currents below 5 mA is not recommended, please contact your Hewlett-Packard sales representative.

**Optical Characteristics at T<sub>A</sub> = 25°C**

Part Number	Luminous Intensity I <sub>v</sub> (mcd) @ 10 mA		Peak Wavelength λ <sub>PEAK</sub> (nm) Typ.	Color, Dominant Wavelength λ <sub>d</sub> <sup>[1]</sup> (nm) Typ.	Viewing Angle 2 θ <sub>1/2</sub> Degrees <sup>[2]</sup> Typ.	Luminous Efficacy η <sub>v</sub> (lm/w)
	Min.	Typ.				
HSMA-TX25	10	25	592	590	120	480
HSMD-TX25	10	25	607	603	120	370
HSMJ-TX25	10	25	621	615	120	263

**Notes:**

1. The dominant wavelength, λ<sub>d</sub>, is derived from the CIE Chromaticity Diagram and represents the color of the device.
2. θ<sub>1/2</sub> is the off-axis angle where the luminous intensity is 1/2 the peak intensity.

**Electrical Characteristics at T<sub>A</sub> = 25°C**

Part Number	Forward Voltage V <sub>F</sub> (Volts) @ I <sub>F</sub> = 10 mA		Reverse Breakdown V <sub>R</sub> (Volts) @ I <sub>R</sub> = 100 μA		Capacitance C (pF) V <sub>F</sub> = 0, f = 1 MHz Typ.	Thermal Resistance R <sub>θJ-PIN</sub> (°C/W)	Speed of Response τ <sub>s</sub> (ns) Time Constant e <sup>-t/τ<sub>s</sub></sup> Typ.
	Typ.	Max.	Min.	Typ.			
HSMA-TX25	1.9	2.4	5	25	40	180	13
HSMD-TX25	1.9	2.4	5	25	40	180	13
HSMJ-TX25	1.9	2.4	5	25	40	180	13

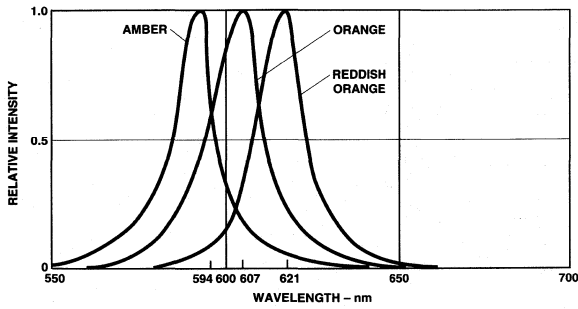

Figure 1. Relative Intensity vs. Wavelength.

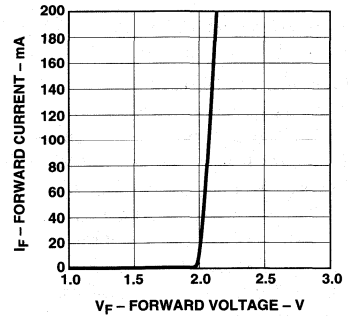

Figure 2. Forward Current vs. Forward Voltage.

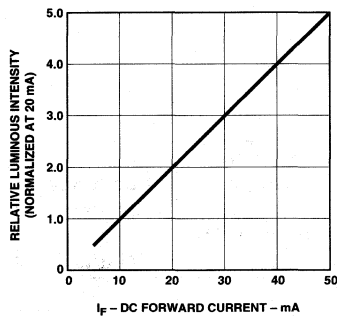

Figure 3. Relative Luminous Intensity vs. Forward Current.

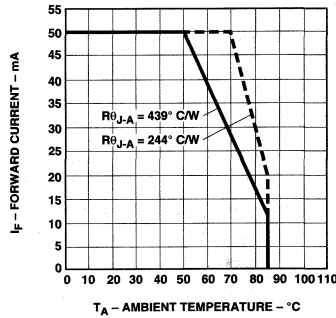

Figure 4. Maximum Forward Current vs. Ambient Temperature. Derating Based on  $T_j$  Max = 95°C.

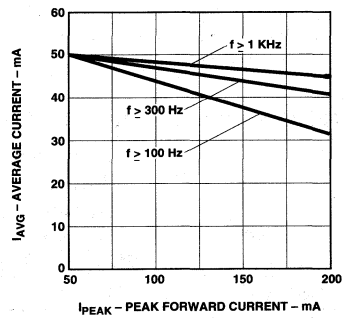

Figure 5. Maximum Average Current vs. Peak Forward Current.

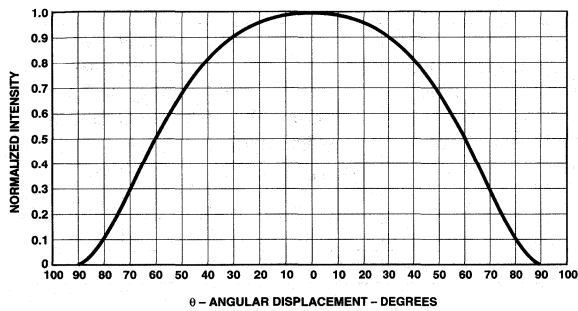
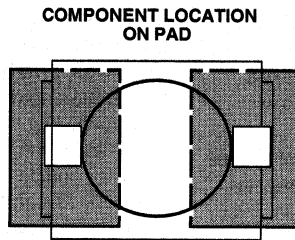
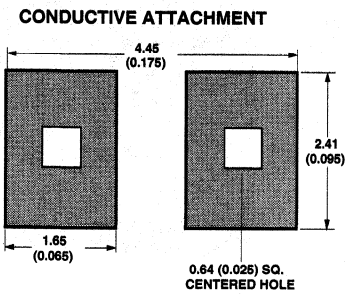
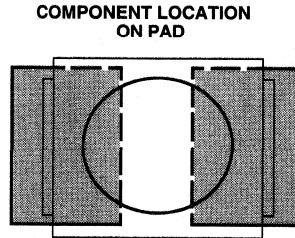
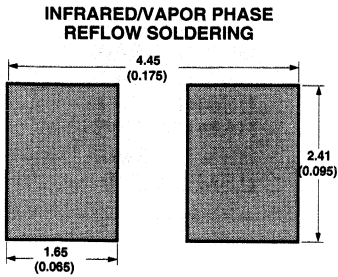

Figure 6. Relative Intensity vs. Angular Displacement.



## Recommended Printed Circuit Board Attachment Pad Geometries



NOTE: ALL DIMENSIONS ARE IN MILLIMETERS (INCHES).

### Convective IR Reflow Soldering

For information on convective IR reflow soldering, refer to the Supplement to Application Note 1060, *Surface Mounting SMT LED Components*.

# Surface Mount LED Indicator

## Technical Data

**HSMD-TX00**  
**HSME-TX00**  
**HSMG-TX00**  
**HSMH-TX00**  
**HSMS-TX00**  
**HSMY-TX00**

### Features

- **Compatible with Automatic Placement Equipment**
- **Compatible with Infrared and Vapor Phase Reflow Solder Processes**
- **Packaged in 12 mm or 8 mm tape on 7" or 13" Diameter Reels**
- **EIA Standard Package**
- **Low Package Profile**
- **Nondiffused Package Excellent for Backlighting and Coupling to Light Pipes**

### Description

These solid state surface mount indicators are designed with a flat top and sides to be easily handled by automatic placement equipment. A glue pad is provided for adhesive mounting processes. They are compatible with convective IR and vapor phase reflow soldering and conductive epoxy attachment processes.

The package size and configuration conform to the EIA-535 BAAC standard specification for case size 3528 tantalum capacitors. The folded leads

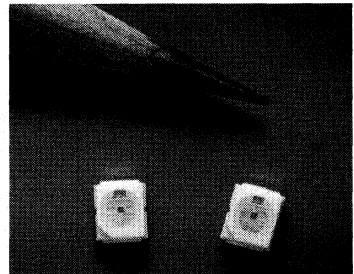

permit dense placement and provide an external solder joint for ease of inspection.

These devices are nondiffused, providing high intensity for applications such as backlighting, light pipe illumination, and front panel indication.

### Device Selection Guide

DH AS AlGaAs Red RSMH-	High Efficiency Red HSMS-	Orange HSMD-	Yellow HSMY-	High Performance Green HSMG-	Emerald Green HSME-	Description
T400	T400	T400	T400	T400	T400	12 mm Tape, 7" Reel, 2000 Devices
T500	T500	T500	T500	T500	T500	12 mm Tape, 13" Reel, 8000 Devices
T600	T600	T600	T600	T600	T600	8 mm Tape, 7" Reel, 2000 Devices
T700	T700	T700	T700	T700	T700	8 mm Tape, 13" Reel, 8000 Devices

### Package Dimensions

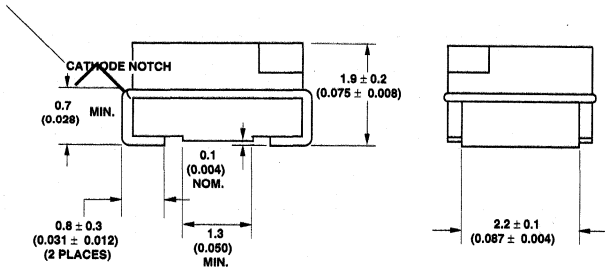
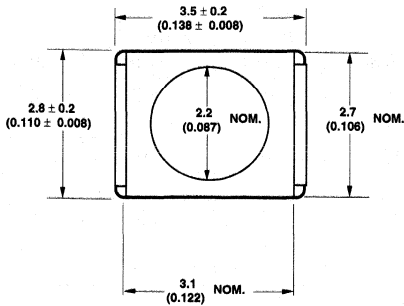

### Tape and Reel Specifications

Hewlett Packard surface mount LEDs are packaged tape and reel in accordance with EIA-481A, *Taping of Surface Mount*

*Components for Automatic Placement.* This packaging system is compatible with taped automatic pick and place systems. Each reel is sealed in a

vapor barrier bag for added protection. Bulk packaging in vapor barrier bags is available upon special request.

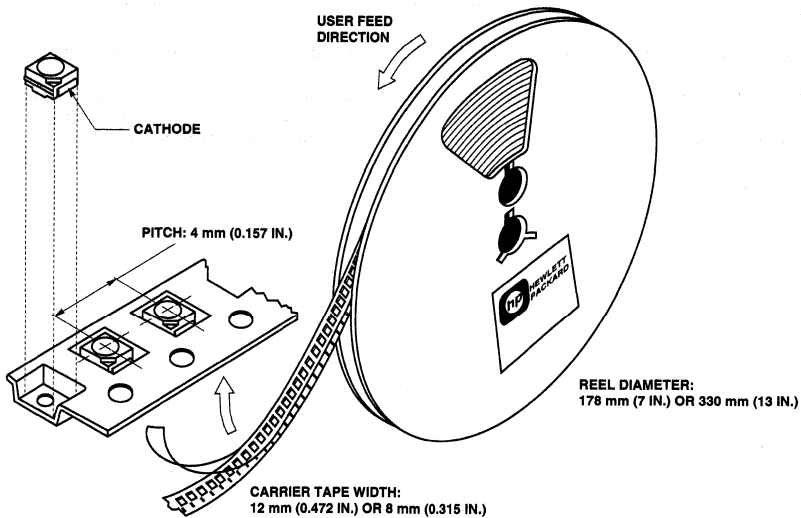

### Absolute Maximum Ratings at $T_A = 25^\circ\text{C}$

Parameter	DH AS AlGaAs Red	High Efficiency Red	Orange	Yellow	High Perf. Green	Emerald Green	Units
DC Forward Current <sup>[1]</sup>	30	30	30	30	30	30	mA
Peak Forward Current <sup>[2]</sup>	300	90	90	60	90	90	mA
Average Forward Current <sup>[2]</sup>	20	25	25	20	25	25	mA
LED Junction Temperature	95						$^\circ\text{C}$
Transient Forward Current <sup>[3]</sup> (10 $\mu\text{s}$ Pulse)	500						mA
Reverse Voltage ( $I_R = 100\text{ mA}$ )	5						V
Operating Temperature Range	-40 to +85					-20 to +85	$^\circ\text{C}$
Storage Temperature Range	-40 to +85						$^\circ\text{C}$
Reflow Soldering Temperature Convective IR Vapor Phase	235 $^\circ\text{C}$ Peak, above 185 $^\circ\text{C}$ for 90 seconds. 215 $^\circ\text{C}$ for 3 minutes.						

**Notes:**

- Derate dc current linearly from 50 $^\circ\text{C}$ : For AlGaAs red, high efficiency red, and green devices at 0.67 mA/ $^\circ\text{C}$ . For yellow devices at 0.44 mA/ $^\circ\text{C}$ .
- Refer to Figure 5 showing Maximum Tolerable Peak Current vs. Pulse duration to establish pulsed operating conditions.
- The transient peak current is the maximum non-recurring peak current the device can withstand without damaging the LED die and wire bond. The device should not be operated at peak currents above the Absolute Maximum Peak Forward Current.

**Electrical/Optical Characteristics at  $T_A = 25^\circ\text{C}$** **DH AS AlGaAs Red HSMH-TX00**

Parameter	Symbol	Min.	Typ.	Max.	Units	Test Conditions
Luminous Intensity	$I_v$	9.0	17.0		mcd	$I_F = 10\text{ mA}$
Forward Voltage	$V_F$		1.8	2.2	V	$I_F = 10\text{ mA}$
Reverse Breakdown Voltage	$V_R$	5.0	15.0		V	$I_R = 100\ \mu\text{A}$
Included Angle Between Half Intensity Points <sup>[1]</sup>	$2\theta_{1/2}$		120		deg.	
Peak Wavelength	$\lambda_{\text{PEAK}}$		645		nm	
Dominant Wavelength <sup>[2]</sup>	$\lambda_d$		637		nm	
Spectral Line Half Width	$\Delta\lambda_{1/2}$		20		nm	
Speed of Response	$\tau_s$		30		ns	Time Constant, $e^{-t/\tau_s}$
Capacitance	C		30		pF	$V_F = 0, f = 1\text{ MHz}$
Thermal Resistance	$R\theta_{\text{J-pin}}$		180		$^\circ\text{C/W}$	Junction-to-Cathode
Luminous Efficacy <sup>[3]</sup>	$\eta_v$		80		lm/W	

**High Efficiency Red HSMS-TX00**

Parameter	Symbol	Min.	Typ.	Max.	Units	Test Conditions
Luminous Intensity	$I_v$	2.0	6.0		mcd	$I_F = 10\text{ mA}$
Forward Voltage	$V_F$		1.9	2.5	V	$I_F = 10\text{ mA}$
Reverse Breakdown Voltage	$V_R$	5.0	30.0		V	$I_R = 100\ \mu\text{A}$
Included Angle Between Half Intensity Points <sup>[1]</sup>	$2\theta_{1/2}$		120		deg.	
Peak Wavelength	$\lambda_{\text{PEAK}}$		635		nm	
Dominant Wavelength <sup>[2]</sup>	$\lambda_d$		626		nm	
Spectral Line Half Width	$\Delta\lambda_{1/2}$		40		nm	
Speed of Response	$\tau_s$		90		ns	Time Constant, $e^{-t/\tau_s}$
Capacitance	C		11		pF	$V_F = 0, f = 1\text{ MHz}$
Thermal Resistance	$R\theta_{\text{J-pin}}$		160		$^\circ\text{C/W}$	Junction-to-Cathode
Luminous Efficacy <sup>[3]</sup>	$\eta_v$		145		lm/W	

**Notes:**

- $\theta_{1/2}$  is the off-axis angle where the luminous intensity is half the on-axis value.
- The dominant wavelength,  $\lambda_d$ , is derived from the CIE Chromaticity Diagram and represents the color of the device.
- The radiant intensity,  $I_e$ , in watts per steradian, may be found from the equation  $I_e = I_v/\eta_v$ , where  $I_v$  is the luminous intensity in candelas and  $\eta_v$  is luminous efficacy in lumens/watt.

### Orange HSMD-TX00

Parameter	Symbol	Min.	Typ.	Max.	Units	Test Conditions
Luminous Intensity	$I_v$	1.5	5.0		mcd	$I_F = 10 \text{ mA}$
Forward Voltage	$V_F$		1.9	2.5	V	$I_F = 10 \text{ mA}$
Reverse Breakdown Voltage	$V_R$	5.0	30.0		V	$I_R = 100 \mu\text{A}$
Included Angle Between Half Intensity Points <sup>[1]</sup>	$2\theta^{1/2}$		120		deg.	
Peak Wavelength	$\lambda_{\text{PEAK}}$		600		nm	
Dominant Wavelength <sup>[2]</sup>	$\lambda_d$		602		nm	
Spectral Line Half Width	$\Delta\lambda_{1/2}$		40		nm	
Speed of Response	$\tau_s$		260		ns	Time Constant, $e^{-t/\tau_s}$
Capacitance	C		4		pF	$V_F = 0, f = 1 \text{ MHz}$
Thermal Resistance	$R\theta_{\text{J-pin}}$		160		°C/W	Junction-to-Cathode
Luminous Efficacy <sup>[3]</sup>	$\eta_v$		380		lm/W	

### Yellow HSMY-TX00

Parameter	Symbol	Min.	Typ.	Max.	Units	Test Conditions
Luminous Intensity	$I_v$	2.0	5.0		mcd	$I_F = 10 \text{ mA}$
Forward Voltage	$V_F$		2.0	2.5	V	$I_F = 10 \text{ mA}$
Reverse Breakdown Voltage	$V_R$	5.0	50.0		V	$I_R = 100 \mu\text{A}$
Included Angle Between Half Intensity Points <sup>[1]</sup>	$2\theta^{1/2}$		120		deg.	
Peak Wavelength	$\lambda_{\text{PEAK}}$		583		nm	
Dominant Wavelength <sup>[2]</sup>	$\lambda_d$		585		nm	
Spectral Line Half Width	$\Delta\lambda_{1/2}$		36		nm	
Speed of Response	$\tau_s$		90		ns	Time Constant, $e^{-t/\tau_s}$
Capacitance	C		15		pF	$V_F = 0, f = 1 \text{ MHz}$
Thermal Resistance	$R\theta_{\text{J-pin}}$		160		°C/W	Junction-to-Cathode
Luminous Efficacy <sup>[3]</sup>	$\eta_v$		500		lm/W	

#### Notes:

- $\theta^{1/2}$  is the off-axis angle where the luminous intensity is half the on-axis value.
- The dominant wavelength,  $\lambda_d$ , is derived from the CIE Chromaticity Diagram and represents the color of the device.
- The radiant intensity,  $I_e$ , in watts per steradian, may be found from the equation  $I_e = I_v / \eta_v$ , where  $I_v$  is the luminous intensity in candelas and  $\eta_v$  is luminous efficacy in lumens/watt.

**High Performance Green HSMG-TX00**

Parameter	Symbol	Min.	Typ.	Max.	Units	Test Conditions
Luminous Intensity	$I_v$	4.0	10.0		mcd	$I_F = 10 \text{ mA}$
Forward Voltage	$V_F$		2.0	2.5	V	$I_F = 10 \text{ mA}$
Reverse Breakdown Voltage	$V_R$	5.0	50.0		V	$I_R = 100 \text{ } \mu\text{A}$
Included Angle Between Half Intensity Points <sup>[1]</sup>	$2\theta^{1/2}$		120		deg.	
Peak Wavelength	$\lambda_{\text{PEAK}}$		570		nm	
Dominant Wavelength <sup>[2]</sup>	$\lambda_d$		572		nm	
Spectral Line Half Width	$\Delta\lambda_{1/2}$		28		nm	
Speed of Response	$\tau_s$		500		ns	Time Constant, $e^{-t/\tau_s}$
Capacitance	C		18		pF	$V_F = 0, f = 1 \text{ MHz}$
Thermal Resistance	$R\theta_{\text{J-pin}}$		160		$^{\circ}\text{C/W}$	Junction-to-Cathode
Luminous Efficacy <sup>[3]</sup>	$\eta_v$		595		lm/W	

**Notes:**

- $\theta^{1/2}$  is the off-axis angle where the luminous intensity is half the on-axis value.
- The dominant wavelength,  $\lambda_d$ , is derived from the CIE Chromaticity Diagram and represents the color of the device.
- The radiant intensity,  $I_e$ , in watts per steradian, may be found from the equation  $I_e = I_v/\eta_v$ , where  $I_v$  is the luminous intensity in candelas and  $\eta_v$  is luminous efficacy in lumens/watt.

**Emerald Green HSME-TX00**

Parameter	Symbol	Min.	Typ.	Max.	Units	Test Conditions
Luminous Intensity	$I_v$	1.0	1.5		mcd	$I_F = 10 \text{ mA}$
Forward Voltage	$V_F$		2.2	2.27	V	$I_F = 10 \text{ mA}$
Reverse Breakdown Voltage	$V_R$	5.0	50.0		V	$I_R = 100 \text{ } \mu\text{A}$
Included Angle Between Half Intensity Points <sup>[1]</sup>	$2\theta^{1/2}$		120		deg.	
Peak Wavelength	$\lambda_{\text{PEAK}}$		558		nm	
Dominant Wavelength <sup>[2]</sup>	$\lambda_d$		560		nm	
Spectral Line Half Width	$\Delta\lambda_{1/2}$		28		nm	
Speed of Response	$\tau_s$		500		ns	Time Constant, $e^{-t/\tau_s}$
Capacitance	C		52		pF	$V_F = 0, f = 1 \text{ MHz}$
Thermal Resistance	$R\theta_{\text{J-pin}}$		120		$^{\circ}\text{C/W}$	Junction-to-Cathode
Luminous Efficacy <sup>[3]</sup>	$\eta_v$		680		lm/W	

**Notes:**

- $\theta^{1/2}$  is the off-axis angle where the luminous intensity is half the on-axis value.
- The dominant wavelength,  $\lambda_d$ , is derived from the CIE Chromaticity Diagram and represents the color of the device.
- The radiant intensity,  $I_e$ , in watts per steradian, may be found from the equation  $I_e = I_v/\eta_v$ , where  $I_v$  is the luminous intensity in candelas and  $\eta_v$  is luminous efficacy in lumens/watt.
- Refer to Application Note 1061 for information comparing high performance green with emerald green light output degradation.

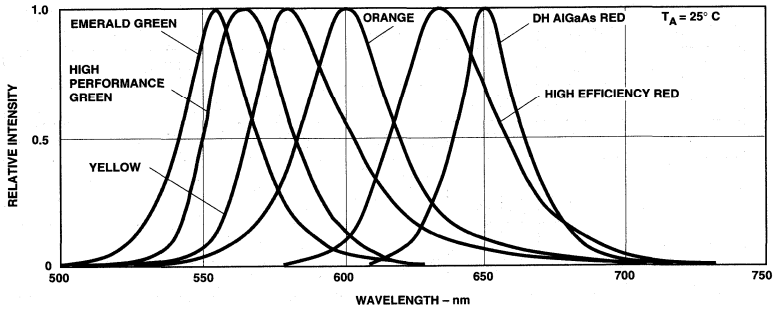

Figure 1. Relative Intensity vs. Wavelength.

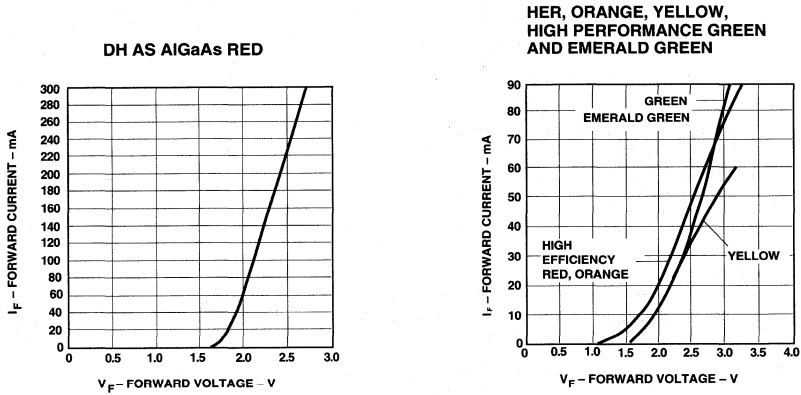

Figure 2. Forward Current vs. Forward Voltage.

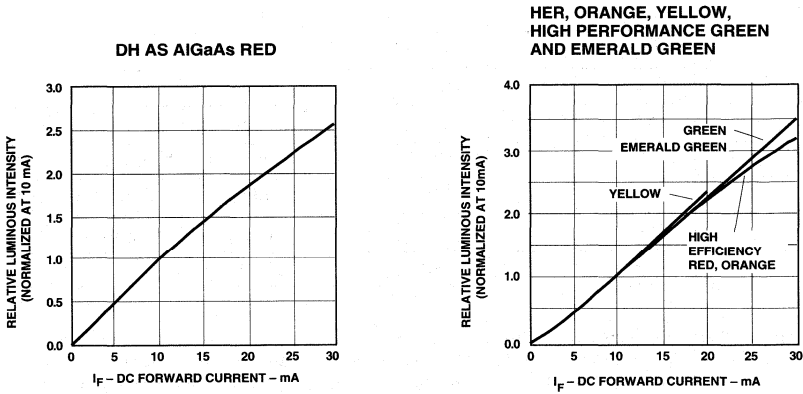

Figure 3. Relative Luminous Intensity vs. Forward Current.



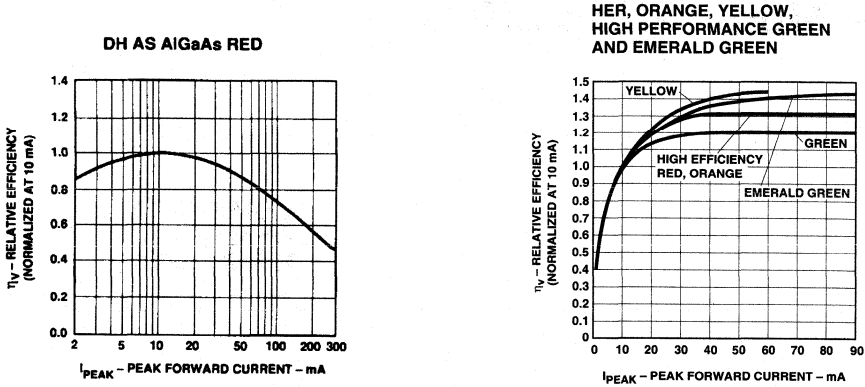

Figure 4. Relative Efficiency (Luminous Intensity per Unit Current) vs. Peak Current.

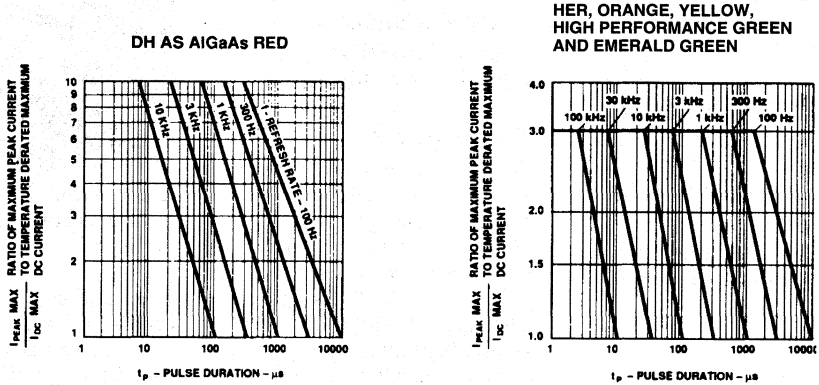

Figure 5. Maximum Tolerable Peak Current vs. Pulse Duration ( $I_{DC}$  MAX per MAX Ratings).

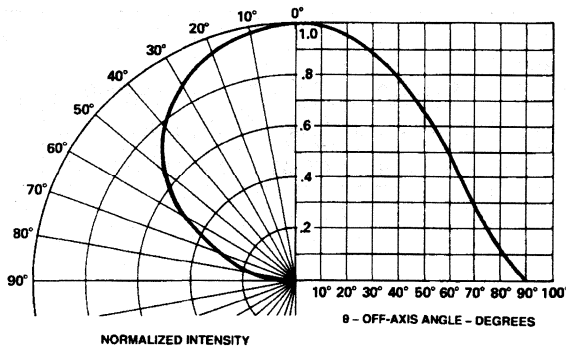

Figure 6. Relative Intensity vs. Angular Displacement.

# Surface Mount Chip LEDs

## Technical Data

**HSMX-C650  
HSMX-C670  
HSMF-C655**

### Features

- **Small Size**
- **Industry Standard Footprint**
- **Low Profile**
- **Tinted, Diffused Optics**
- **Compatible with IR Solder Process**
- **Five Colors and Bicolor Available**
- **Available in 8 mm Tape on 7" (178 mm) Diameter Reels**

### Applications

- **Push-Button Backlighting**
- **LCD Backlighting**
- **Symbol Backlighting**
- **Front Panel Indicator**

### Description

These single and bicolor LEDs are designed in an industry standard package for ease of handling and use. Five different LED colors are available in two compact, low profile, single color packages. The 3.2 x 1.6 mm is an excellent all around package, and the small 2.0 x 1.25 mm package is designed for applications where space is limited. The single color LEDs have

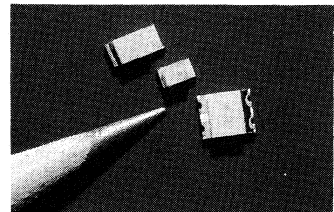

tinted diffused optics. The bicolor package is untinted, diffused.

The small size, low 1.1 mm profile and wide viewing angle make these LEDs excellent for backlighting applications and front panel illumination. They are compatible with IR reflow soldering processes.

### Device Selection Guide

Footprint (mm)	DH AlGaAs Red	High Efficiency Red	Orange	Yellow	Green	Bicolor HER-Green
3.20 x 1.60	HSMH-C650	HSMS-C650	HSMO-C650	HSMY-C650	HSMG-C650	
2.00 x 1.25	HSMH-C670	HSMS-C670	HSMO-C670	HSMY-C670	HSMG-C670	
3.20 x 2.70						HSMF-C655

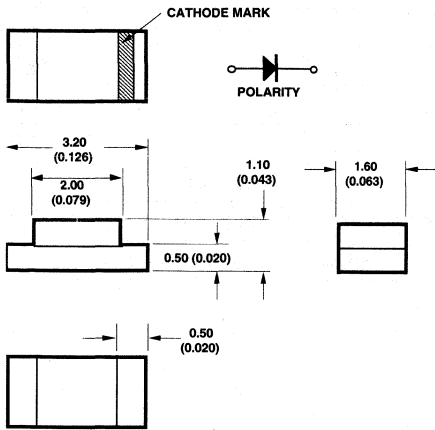

HSMX-C650 Series

[1206]

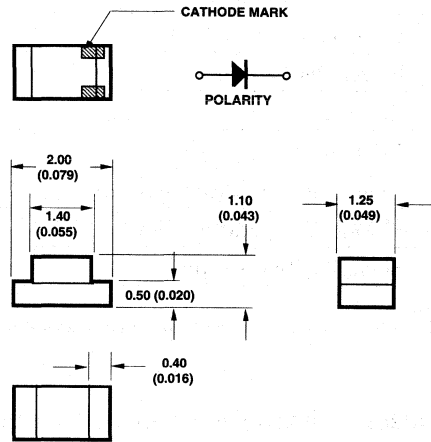

HSMX-C670 Series

[805]

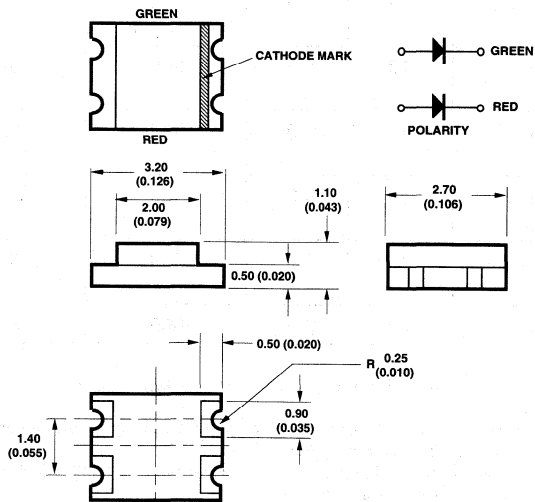

HSMF-C655

[1210]

### Absolute Maximum Ratings at $T_A = 25^\circ\text{C}$

Parameter	HSMX-C650 HSMF-C655	HSMX-C670	Units
DC Forward Current <sup>[1]</sup>	25	20	mA
Power Dissipation	65	50	mW
Reverse Voltage ( $I_R = 100 \mu\text{A}$ )	5	5	V
LED Junction Temperature	95	95	$^\circ\text{C}$
Operating Temperature Range	-25 to +80	-25 to +80	$^\circ\text{C}$
Storage Temperature Range	-30 to +85	-30 to +85	$^\circ\text{C}$
Soldering Temperature	See SMT reflow soldering profile, Figure 6		

**Notes:**

- Derate linearly as shown in Figure 4 for temperatures above  $25^\circ\text{C}$ .

### Optical Characteristics at $T_A = 25^\circ\text{C}$

Part Number	Color	Luminous Intensity $I_V$ (mcd) @ $I_F 20 \text{ mA}^{[1]}$		Peak Wavelength $\lambda_{\text{peak}}$ (nm) Typ.	Color, Dominant Wavelength $\lambda_d^{[2]}$ (nm) Typ.	Viewing Angle $2\theta^{1/2}$ Degrees <sup>[3]</sup> Typ.
		Min.	Typ.			
HSMH-C650 HSMH-C670	DH AlGaAs Red	6.3	16.0	650	639	155
HSMS-C650 HSMS-C670	High Efficiency Red	1.6	5.0	639	626	155
HSMD-C650 HSMD-C670	Orange	1.6	4.0	606	604	155
HSMY-C650 HSMY-C670	Yellow	1.6	5.0	584	586	155
HSMG-C650 HSMG-C670	Green	4.0	9.0	566	571	155
HSMF-C655	High Efficiency Red	1.6	5.0	639	626	155
	Green	4.0	9.0	566	571	155

**Notes:**

- The luminous intensity,  $I_V$ , is measured at the peak of the spatial radiation pattern which may not be aligned with the mechanical axis of the lamp package.
- The dominant wavelength,  $\lambda_d$ , is derived from the CIE Chromaticity Diagram and represents the perceived color of the device.
- $\theta^{1/2}$  is the off-axis angle where the luminous intensity is 1/2 the peak intensity.
- Chip LEDs are supplied in 8 mm embossed tape on 178 mm (7 in.) diameter reels, with 3000 devices per reel. Minimum order quantity and order increments are in quantity of reels only.

**Electrical Characteristics at  $T_A = 25^\circ\text{C}$**

Part Number	Color	Forward Voltage $V_F$ (Volts) @ $I_F = 20\text{ mA}$		Reverse Breakdown $V_R$ (Volts) @ $I_R = 100\ \mu\text{A}$ Min.	Capacitance C (pF) $V_F = 0, f = 1\text{ MHz}$ Typ.	Thermal Resistance $R_{\theta\text{J-PIN}}$ ( $^\circ\text{C/W}$ )
		Typ.	Max.			
HSMH-C650 HSMH-C670	DH AlGaAs Red	1.8	2.2	5	46	460 300
HSMS-C650 HSMS-C670	High Efficiency Red	1.9	2.6	5	4.0	400 250
HSMD-C650 HSMD-C670	Orange	2.1	2.6	5	4.0	400 250
HSMY-C650 HSMY-C670	Yellow	2.1	2.6	5	3.0	400 250
HSMG-C650 HSMG-C670	Green	2.2	3.0	5	8.0	400 250
HSMF-C655	High Efficiency Red	1.9	2.6	5	3.7	325
	Green	2.2	3.0	5	6.3	325

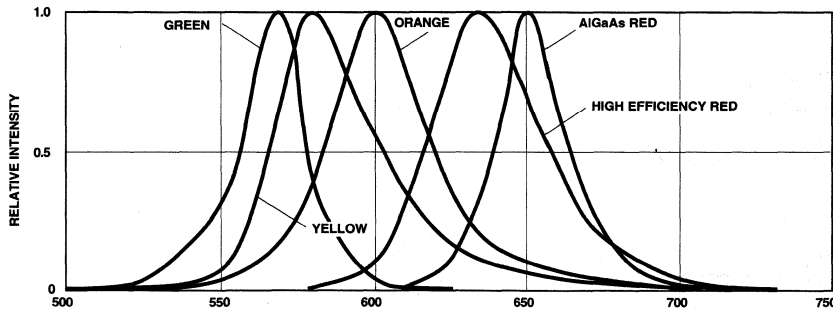

Figure 1. Relative Intensity vs. Wavelength.

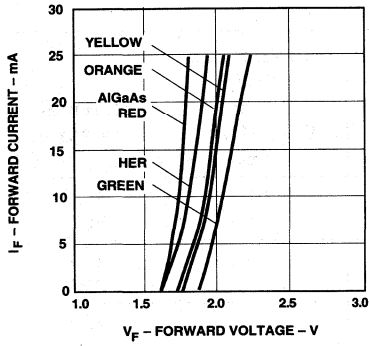

Figure 2. Forward Current vs. Forward Voltage.

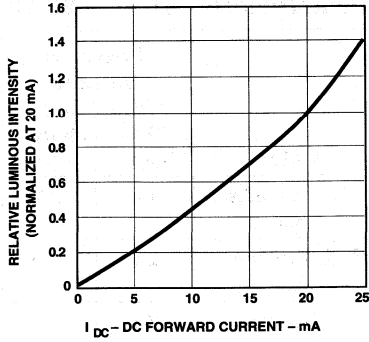

Figure 3. Relative Luminous Intensity vs. DC Forward Current.

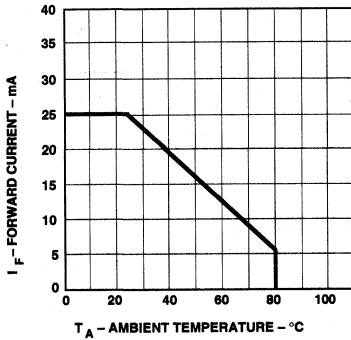

Figure 4. Maximum DC Current vs. Ambient Temperature.

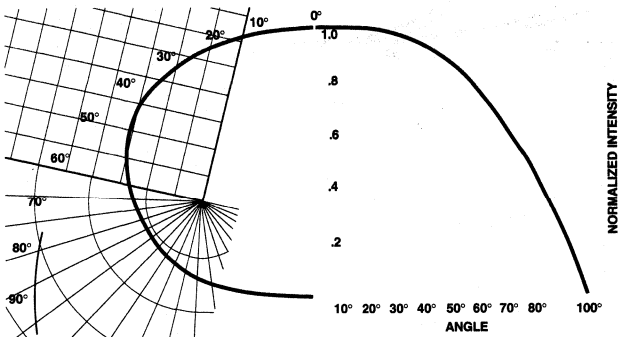

Figure 6. Intensity vs. Angle.

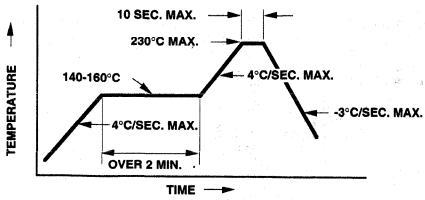

Figure 6. Recommended SMT Reflow Soldering Profile.

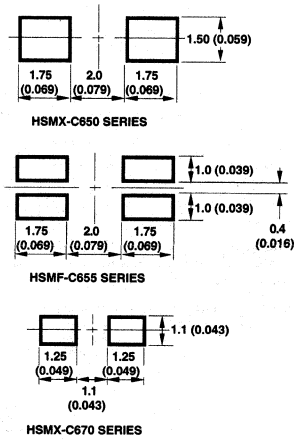

Figure 7. Recommended Solder Patterns.

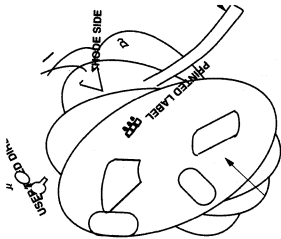

Figure 8. Reeling Orientation.

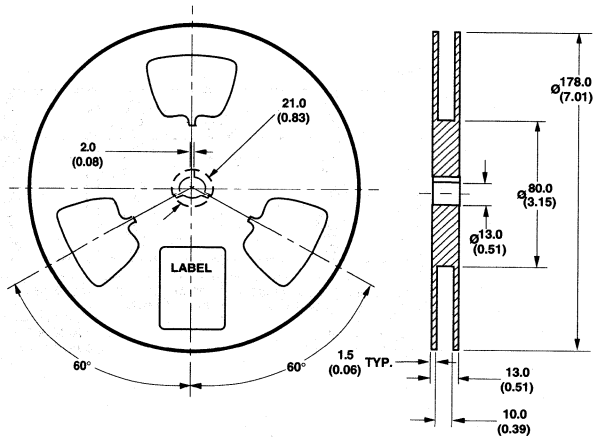

Figure 9. Reel Dimensions.

NOTE:  
ALL DIMENSIONS IN MILLIMETERS (INCHES).

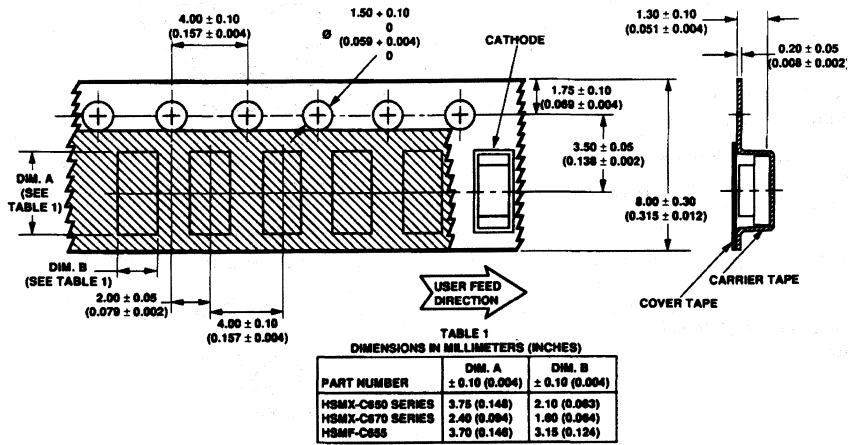

Figure 10. Tape Dimensions.

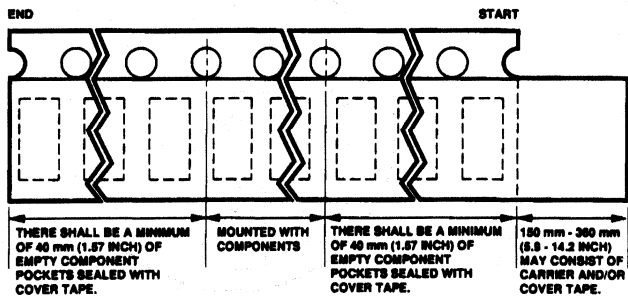

Figure 11. Tape Leader and Trailer Dimensions.



# Standard Intensity and Color Binning Options for LED Lamps

## Technical Data

### Option S02, S20, S22

#### Description

Due to applications that require tightly matched devices, Hewlett-Packard has developed several standard options to service these requirements.

Option S02 consists of devices which are selected to two Iv categories. All color bins of the base parts (yellow and green devices) fulfill the color requirements of these products.

Option S20 consists of devices which are selected to two color bins. All Iv bins of the base parts fulfill the Iv requirements of these products.

Option S22 consists of devices which are selected to two Iv categories and two color bin categories.

#### Ordering Information

To order LED indicators with these standard options, order the base part number and add the option code (S02, S20, S22). For any base part number that does not appear in the following lists, please consult your local Hewlett-Packard representative or your local franchise distributor.

#### Option S02 – Partial base part number list:

HLMP-D101	HLMP-1440
HLMP-D105	HLMP-1485
HLMP-D150	HLMP-1521
HLMP-D155	HLMP-1523
HLMP-D401	HLMP-1540
HLMP-K100	HLMP-1550
HLMP-K101	HLMP-1585
HLMP-K105	HLMP-1600
HLMP-K150	HLMP-1601
HLMP-K155	HLMP-1620
HLMP-K402	HLMP-1640
HLMP-L250	HLMP-1700
HLMP-R100	HLMP-1719
HLMP-S200	HLMP-1790
HLMP-S300	HLMP-3001
HLMP-S400	HLMP-3002
HLMP-S500	HLMP-3301
HLMP-T200	HLMP-3316
HLMP-T300	HLMP-3351
HLMP-T500	HLMP-3401
HLMP-0300	HLMP-3416
HLMP-0400	HLMP-3451
HLMP-0503	HLMP-3502
HLMP-0800	HLMP-3507
HLMP-1002	HLMP-3517
HLMP-1100	HLMP-3519
HLMP-1120	HLMP-3554
HLMP-1301	HLMP-3600
HLMP-1302	HLMP-3650
HLMP-1320	HLMP-3680
HLMP-1321	HLMP-3744
HLMP-1340	HLMP-3750
HLMP-1385	HLMP-3810
HLMP-1402	HLMP-3850
HLMP-1421	HLMP-3860
	HLMP-3910
	HLMP-3950
	HLMP-3960

HLMP-4000  
HLMP-4600  
HLMP-4700  
HLMP-4719  
HLMP-4740  
HLMP-5030  
HLMP-5040  
HLMP-5050  
HLMP-5060  
HLMP-5070  
HLMP-5080  
HLMP-6001  
HLMP-6300  
HLMP-6305  
HLMP-6400  
HLMP-6500  
HLMP-6505  
HLMP-7000  
HLMP-7019  
HLMP-7040  
HLMP-8109

HLMP-8110  
HLMP-8115  
HLMP-8205  
HLMP-8209  
HLMP-8305  
HLMP-8309  
HLMP-8320  
HLMP-8405  
HLMP-8409  
HLMP-8505  
HLMP-8509  
HLMP-8510  
HLMP-8520

**OPTION S20 - Partial base  
part number list:**

HLMP-1620  
HLMP-1640  
HLMP-3400  
HLMP-3651

**OPTION S22 - Partial base  
part number list:**

HLMP-S301  
HMLP-S500  
HLMP-T300  
HLMP-T500  
HLMP-0401  
HLMP-0504  
HLMP-1402  
HLMP-1440  
HLMP-1523  
HLMP-1620  
HLMP-1719  
HLMP-3401  
HLMP-3450  
HLMP-3850  
HLMP-3862  
HLMP-4719

# LED Light Bars and Bar Graph Arrays

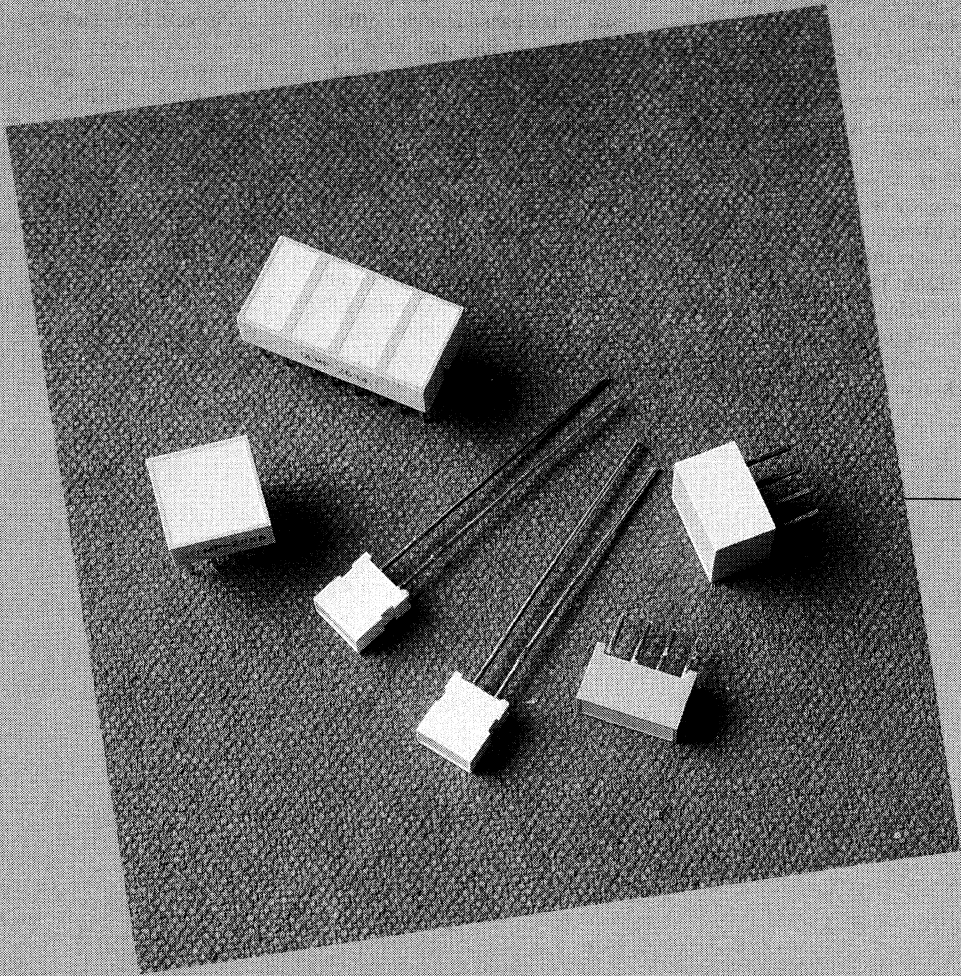

---

## LED Light Bars and Arrays

---



LED Light Bars are Hewlett-Packard's innovative solution to fixed message annunciation. The large, uniformly illuminated light emitting surface may be used for backlighting legends or simple indicators. Four distinct colors are offered: AlGaAs red, high efficiency red, yellow, and high performance green with two bicolor combinations. The AlGaAs Red Light Bars provide exceptional brightness at very low drive currents for those applications where portability and battery backup are important considera-

tions. Each of the eight X-Y stackable package styles offers one, two, or four light emitting surfaces. Along with this family of stackable light bars, HP also provides a single chip light bar for high brightness indication of small areas. Panel Mounts are also available for all devices.

In addition to light bars, HP offers effective analog message annunciation with the 10-element LED Bar Graph Arrays. These bar graph arrays eliminate the matching and alignment problems

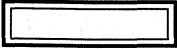

commonly associated with arrays of discrete LED indicators. Each device offers easy to handle packages that are compatible with standard DIP sockets. The 10-element Bar Graph Array is available in standard red, AlGaAs red, high efficiency red, yellow, and high performance green. The multicolor 10-element arrays have high efficiency red, yellow, and green LEDs in one package. The package is X-Y stackable, with a unique interlock allowing easy end-to-end alignment.

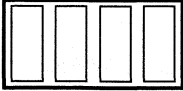
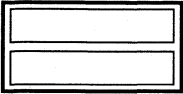
## LED Light Bars

Device		Description			Typical Luminous Intensity @ 20 mA	Typical Forward Voltage @ 20 mA	Page No.
Package Outline Drawing	Part No.	Color	Package	Lens			
	HLMP-2300	High Efficiency Red	4 Pin In-Line; 0.100" Centers; 0.400"L x 0.195"W x 0.245"H	Diffused	23 mcd	2.0 V	2-8
	HLMP-2400	Yellow		Diffused	20 mcd	2.1 V	
	HLMP-2500	Green		Green Diffused	25 mcd	2.2 V	
	HLMP-2350	High Efficiency Red	8 Pin In-Line; 0.100" Centers; 0.800"L x 0.195"W x 0.245"H	Diffused	45 mcd	2.0 V	
	HLMP-2450	Yellow		Diffused	38 mcd	2.1 V	
	HLMP-2550	Green		Green Diffused	50 mcd	2.2 V	
	HLMP-2600	High Efficiency Red	8 Pin DIP; 0.100" Centers; 0.400"L x 0.400"W x 0.245"H Dual Arrangement	Diffused	22 mcd	2.0 V	
	HLMP-2700	Yellow		Diffused	18 mcd	2.1 V	
	HLMP-2800	Green		Green Diffused	25 mcd	2.2 V	
	HLMP-2620	High Efficiency Red	16 Pin DIP; 0.100" Centers; 0.800"L x 0.400"W x 0.245"H Quad Arrangement	Diffused	25 mcd	2.0 V	
	HLMP-2720	Yellow		Diffused	18 mcd	2.1 V	
	HLMP-2820	Green		Green Diffused	25 mcd	2.2 V	
	HLMP-2635	High Efficiency Red	16 Pin DIP; 0.100" Centers; 0.800"L x 0.400"W x 0.245"H Dual Bar Arrangement	Diffused	45 mcd	2.0 V	
	HLMP-2735	Yellow		Diffused	35 mcd	2.1 V	
	HLMP-2835	Green		Green Diffused	50 mcd	2.2 V	

LIGHT BARS AND BAR GRAPH ARRAYS

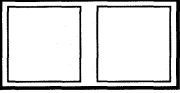

### LED Light Bars (Continued)

Device		Description			Typical Luminous Intensity @ 20 mA	Typical Forward Voltage @ 20 mA	Page No.
Package Outline Drawing	Part No.	Color	Package	Lens			
	HLMP-2655	High Efficiency Red	8 Pin DIP; 0.100" Centers; 0.400"L x 0.400"W x 0.245"H Square Arrangement	Diffused	43 mcd	2.0 V	2-8
	HLMP-2755	Yellow		Diffused	35 mcd	2.1 V	
	HLMP-2855	Green		Green Diffused	50 mcd	2.2 V	
	HLMP-2670	High Efficiency Red	16 Pin DIP; 0.100" Centers; 0.800"L x 0.400"W x 0.245"H Dual Square Arrangement	Diffused	45 mcd	2.0 V	
	HLMP-2770	Yellow		Diffused	35 mcd	2.1 V	
	HLMP-2870	Green		Green Diffused	50 mcd	2.2 V	
	HLMP-2685	High Efficiency Red	16 Pin DIP; 0.100" Centers; 0.800"L x 0.400"W x 0.245"H Single Bar Arrangement	Diffused	80 mcd	2.0 V	
	HLMP-2785	Yellow		Diffused	70 mcd	2.1 V	
	HLMP-2885	Green		Green Diffused	100 mcd	2.2 V	

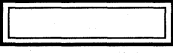
### DH AlGaAs Low Current LED Light Bars

Device		Description			Typical Luminous Intensity @ 3 mA	Typical Forward Voltage @ 3mA	Page No.
Package Outline Drawing	Part No.	Color	Package	Lens			
	HLCP-A100	AlGaAs Red	4 Pin In-Line; 0.100" Centers; 0.400"L x 0.195"W x 0.245"H	Diffused	7.5 mcd	1.6 V	2-8
	HLCP-B100	AlGaAs Red	8 Pin In-Line; 0.100" Centers; 0.800"L x 0.195"W x 0.245"H	Diffused	15.0 mcd		

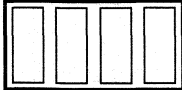
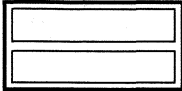
## DH AlGaAs Low Current LED Light Bars (Continued)

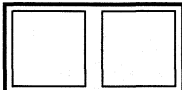
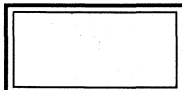
Device		Description			Typical Luminous Intensity @ 3 mA	Typical Forward Voltage @ 3 mA	Page No.
Package Outline Drawing	Part No.	Color	Package	Lens			
	HLCP-D100	AlGaAs Red	8 Pin DIP; 0.100" Centers; 0.400"L x 0.400"W x 0.245"H Dual Arrangement	Diffused	7.5 mcd	1.6 V	2-8
	HLCP-E100	AlGaAs Red	16 Pin DIP; 0.100" Centers; 0.800"L x 0.400"W x 0.245"H Quad Arrangement	Diffused	7.5 mcd		
	HLCP-F100	AlGaAs Red	16 Pin DIP; 0.100" Centers; 0.800"L x 0.400"W x 0.245"H Dual Bar Arrangement	Diffused	15.0 mcd		
	HLCP-C100	AlGaAs Red	8 pin DIP; 0.100" Centers; 0.400"L x 0.400"W x 0.245"H Square Arrangement	Diffused	15.0 mcd		
	HLCP-G100	AlGaAs Red	16 Pin DIP; 0.100" Centers; 0.800"L x 0.400"W x 0.245"H Dual Square Arrangement	Diffused	15.0 mcd		
	HLCP-H100	AlGaAs Red	16 Pin DIP; 0.100" Centers; 0.800"L x 0.400"W x 0.245"H Single Bar Arrangement	Diffused	30.0 mcd		

LIGHT BARS AND BAR GRAPH ARRAYS

## LED Bicolor Light Bars

Device		Description			Typical Luminous Intensity @ 20 mA	Typical Forward Voltage @ 20 mA	Page No.
Package Outline Drawing	Part No.	Color	Package	Lens			
	HLMP-2950	High Efficiency Red/ Yellow	8 Pin DIP; 0.100" Centers; 0.400"L x 0.400"W x 0.245"H Square Arrangement	Diffused	HER: 20 mcd Yellow: 12 mcd	HER: 2.0 V Yellow: 2.1 V	2-8
	HLMP-2965	High Efficiency Red/ Green		Diffused	HER: 20 mcd Green: 20 mcd	HER: 2.0 V Green: 2.2 V	

## Single Chip LED Light Bar

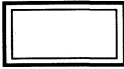

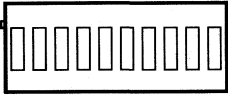

Device		Description			Typical Luminous Intensity	2θ 1/2	Typical Forward Voltage	Page No.
Package Outline Drawing	Part No.	Color	Package	Lens				
	HLMP-T200	High Efficiency Red (626 nm)	One Chip LED Light Bar	Tinted Diffused	4.8 mcd @ 20 mA	100°	2.2 V @ 20 mA	2-19
	HLMP-T300	Yellow (585 nm)			6.0 mcd @ 20 mA		2.2 V @ 20 mA	
	HLMP-T400	Orange (608 nm)			4.8 mcd @ 20 mA		2.2 V @ 20 mA	
	HLMP-T500	Green (569 nm)			6.0 mcd @ 20 mA		2.3 V @ 20 mA	

## LED Bar Graph Arrays

Device		Description			Typical Luminous Intensity	Typical Forward Voltage	Page No.
Package Outline Drawing	Part No.	Color	Package	Lens			
	HDSP-4820	Standard Red	20 Pin DIP; 0.100" Centers; 1.0"L x 0.400"W x 0.200"	Diffused	1250 μcd @ 20 mA DC	1.6 V @ 20 mA DC	2-23
	HDSP-4830	High Efficiency Red			3500 μcd @ 10 mA DC	2.1 V @ 20 mA DC	
	HDSP-4840	Yellow			1900 μcd @ 10 mA DC	2.2 V @ 20 mA DC	
	HDSP-4850	High Performance Green			1900 μcd @ 10 mA DC	2.1 V @ 20 mA DC	
	HDSP-4832	Multicolor			1900 μcd @ 10 mA DC		
	HDSP-4836	Multicolor			1900 μcd @ 10 mA DCC		
	HLCP-J100	AlGaAs Red			1000 μcd @ 10 mA	1.6 V @ 1 mA	



### Panel Mounts for LED Light Bars

Device		Corresponding Light Bar Module Part Number	Page No.
Package Outline Drawing	Part No.		
	HLMP-2598	HLMP-2350, -2450, -2550, HLCP-B100	2-30
	HLMP-2599	HLMP-2300, -2400, -2500, HLCP-A100	
	HLMP-2898	HLMP-2600, -2700, -2800 -2655, -2755, -2855 -2950, -2965, HLCP-C100, -D100	
	HLMP-2899	HLMP-2620, -2720, -2820, -2635, -2735, -2835 -2670, -2770, -2870 -2685, -2785, -2885 HLCP-E100, -F100, -G100, -H100	

LIGHT BARS AND  
BAR GRAPH ARRAYS

### LED Light Bars Standard Options

Option Code	Description	Page No.
S02	Devices Selected to Two (2) Iv Categories	2-33
S22	Devices Selected to Two (2) Iv Categories and Two (2) Color Bin Categories	

---

# LED Light Bars

## Technical Data

**HLCP-A100, -B100, -C100,  
-D100, -E100, -F100, -G100,  
-H100**

**HLMP-2300, -2350, -2400,  
-2450, -2500, -2550, -2600,  
-2620, -2635, -2655, -2670,  
-2685, -2700, -2720, -2735,  
-2755, -2770, -2785, -2800,  
-2820, -2835, -2855, -2870,  
-2885, -2950, -2965**

---

### Features

- **Large Bright, Uniform Light Emitting Areas**
- **Choice of Colors**
- **Categorized for Light Output**
- **Yellow and Green**
- **Categorized for Dominant Wavelength**
- **Excellent ON-OFF Contrast**
- **X-Y Stackable**
- **Flush Mountable**
- **Can be Used with Panel and Legend Mounts**
- **Light Emitting Surface Suitable for Legend Attachment per Application Note 1012**
- **HLCP-X100 Series Designed for Low Current Operation**
- **Bicolor Devices Available**

---

### Applications







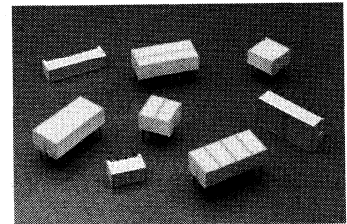



- **Business Machine Message Annunciators**
- **Telecommunications Indicators**
- **Front Panel Process Status Indicators**
- **PC Board Identifiers**
- **Bar Graphs**

### Description

The HLCP-X100 and HLMP-2XXX series light bars are rectangular light sources designed for a variety of applications where a large bright source of light is required. These light bars are configured in single-in-line and dual-in-line packages that contain either single or segmented light emitting areas. The AlGaAs Red HLCP-X100 series LEDs use double heterojunction AlGaAs on a GaAs substrate. The HER HLMP-2300/2600 and Yellow HLMP-2400/2700 series LEDs have their p-n junctions diffused into a GaAsP epitaxial layer on a GaP substrate. The Green HLMP-2500/2800 series LEDs use a liquid phase GaP epitaxial layer on a GaP substrate. The bicolor HLMP-2900 series use a combination of HER/Yellow or HER/Green LEDs.



## Selection Guide

Light Bar Part Number				Size of Light Emitting Areas	Number of Light Emitting Areas	Package Outline	Corresponding Panel and Legend Mount Part No. HLMP-
HLCP-	HLMP-						
AlGaAs	HER	Yellow	Green				
A100	2300	2400	2500	8.89 mm x 3.81 mm (.350 in. x .150 in.)	1	A 	2599
B100	2350	2450	2550	19.05 mm x 3.81 mm (.750 in. x .150 in.)	1	B 	2598
D100	2600	2700	2800	8.89 mm x 3.81 mm (.350 in. x .150 in.)	2	D 	2898
E100	2620	2720	2820	8.89 mm x 3.81 mm (.350 in. x .150 in.)	4	E 	2899
F100	2635	2735	2835	3.81 mm x 19.05 mm (.150 in. x .750 in.)	2	F 	2899
C100	2655	2755	2855	8.89 mm x 8.89 mm (.350 in. x .350 in.)	1	C 	2898
G100	2670	2770	2870	8.89 mm x 8.89 mm (.350 in. x .350 in.)	2	G 	2899
H100	2685	2785	2885	8.89 mm x 19.05 mm (.350 in. x .750 in.)	1	H 	2899
	2950	2950		8.89 mm x 8.89 mm (.350 in. x .350 in.)	Bicolor	I 	2898
	2965		2965	8.89 mm x 8.89 mm (.350 in. x .350 in.)	Bicolor	I 	2898

LIGHT BARS AND  
BAR GRAPH ARRAYS

# Package Dimensions

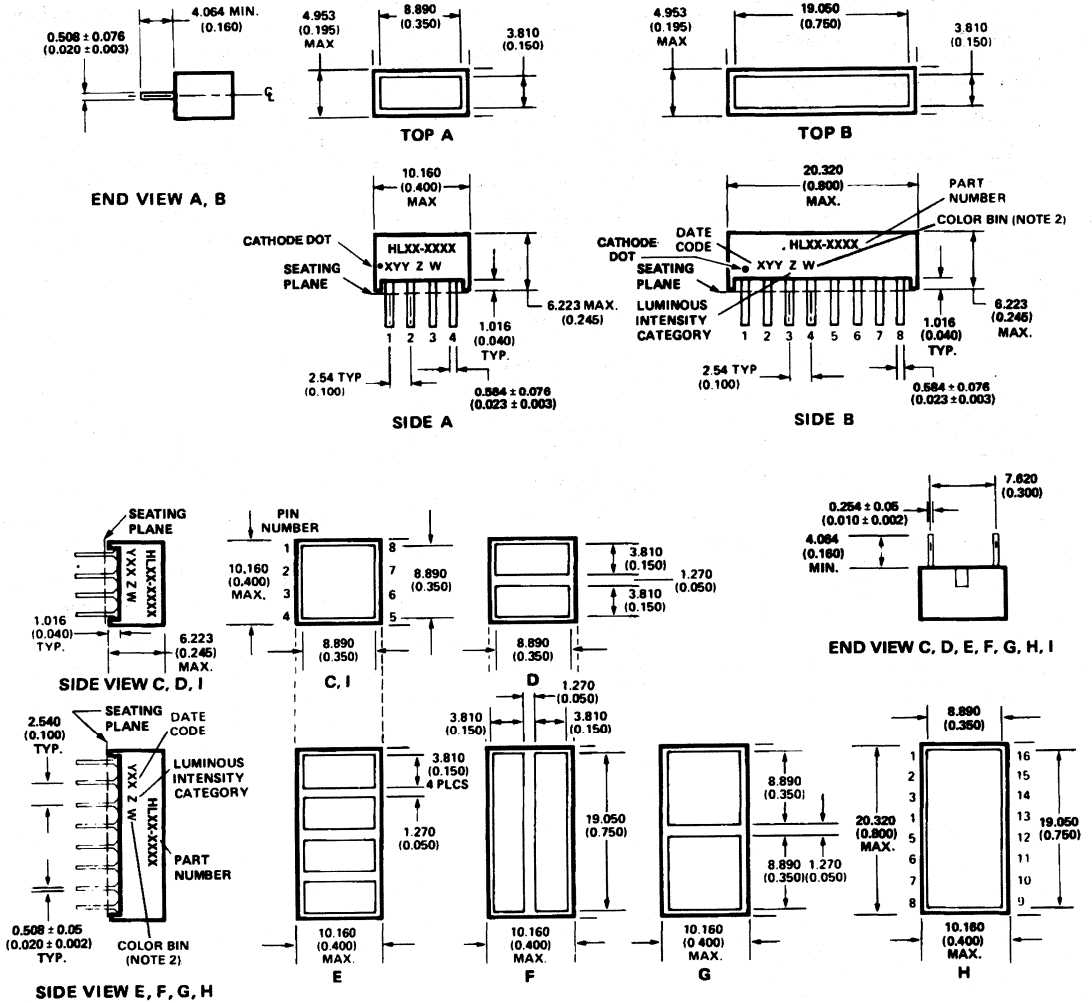

- NOTES:**
1. DIMENSIONS IN MILLIMETRES (INCHES). TOLERANCES ±0.25 mm (±0.010 IN.) UNLESS OTHERWISE INDICATED.
  2. FOR YELLOW AND GREEN DEVICES ONLY.

# Internal Circuit Diagrams

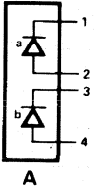

A

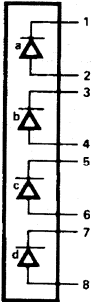

B

PIN FUNCTION		
PIN	A	B
	-2300/-2400 -2500/A100	-2350/-2450 -2550/B100
1	CATHODE a	CATHODE a
2	ANODE a	ANODE a
3	CATHODE b	CATHODE b
4	ANODE b	ANODE b
5		CATHODE c
6		ANODE c
7		CATHODE d
8		ANODE d

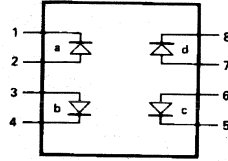

C,D

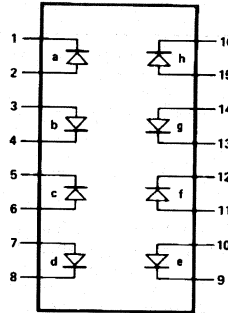

E,F,G,H

PIN	PIN FUNCTION	
	C, D	E, F, G, H
1	CATHODE a	CATHODE a
2	ANODE a	ANODE a
3	ANODE b	ANODE b
4	CATHODE b	CATHODE b
5	CATHODE c	CATHODE c
6	ANODE c	ANODE c
7	ANODE d	ANODE d
8	CATHODE d	CATHODE d
9		CATHODE e
10		ANODE e
11		ANODE f
12		CATHODE f
13		CATHODE g
14		ANODE g
15		ANODE h
16		CATHODE h

LIGHT BARS AND BAR GRAPH ARRAYS

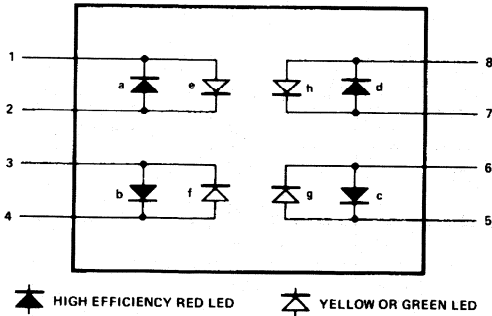

HIGH EFFICIENCY RED LED    
 YELLOW OR GREEN LED

PIN	PIN FUNCTION	
	HER	YELLOW/GREEN
1	CATHODE a	ANODE e
2	ANODE a	CATHODE e
3	ANODE b	CATHODE f
4	CATHODE b	ANODE f
5	CATHODE c	ANODE g
6	ANODE c	CATHODE g
7	ANODE d	CATHODE h
8	CATHODE d	ANODE h

## Absolute Maximum Ratings

Parameter	AlGaAs Red HLCP-X100 Series	HER HLMP-2300/ 2600/29XX Series	Yellow HLMP-2400/ 2700/2950 Series	Green HLMP-2500/ 2800/2965 Series
Average Power Dissipated per LED Chip	37 mW <sup>[1]</sup>	135 mW <sup>[2]</sup>	85 mW <sup>[3]</sup>	135 mW <sup>[2]</sup>
Peak Forward Current per LED Chip	45 mA <sup>[4]</sup>	90 mA <sup>[5]</sup>	60 mA <sup>[5]</sup>	90 mA <sup>[5]</sup>
Average Forward Current per LED Chip	15 mA	25 mA	20 mA	25 mA
DC Forward Current per LED Chip	15 mA <sup>[1]</sup>	30 mA <sup>[2]</sup>	25 mA <sup>[3]</sup>	30 mA <sup>[2]</sup>
Reverse Voltage per LED Chip	5 V	6 V <sup>[6]</sup>		
Operating Temperature Range	-20°C to +100°C <sup>[7]</sup>	-40°C to +85°C		-20°C to +85°C
Storage Temperature Range	-40°C to +85°C			
Lead Soldering Temperature 1.6 mm (1/16 inch) Below Seating Plane <sup>3</sup>	260°C for 3 seconds <sup>[8]</sup>			

### Notes:

- Derate above 87°C at 1.7 mW/°C per LED chip. For DC operation, derate above 91°C at 0.8 mA/°C.
- Derate above 25°C at 1.8 mW/°C per LED chip. For DC operation, derate above 50°C at 0.5 mA/°C.
- Derate above 50°C at 1.8 mW/°C per LED chip. For DC operation, derate above 60°C at 0.5 mA/°C.
- See Figure 1 to establish pulsed operation. Maximum pulse width is 1.5 mS.
- See Figure 6 to establish pulsed operation. Maximum pulse width is 2 mS.
- Does not apply to bicolor parts.
- For operation below -20°C, contact your local HP sales representative.
- Maximum tolerable component side temperature is 134°C during solder process.

## Electrical/Optical Characteristics at T<sub>A</sub> = 25°C AlGaAs Red HLCP-X100 Series

Parameter	HLCP-	Symbol	Min.	Typ.	Max.	Units	Test Conditions
Luminous Intensity per Lighting Emitting Area <sup>[1]</sup>	A100/D100/E100	I <sub>V</sub>	3	7.5		mcd	I <sub>F</sub> = 3 mA
	B100/C100/F100/G100		6	15		mcd	
	H100		12	30		mcd	
Peak Wavelength		λ <sub>PEAK</sub>		645		nm	
Dominant Wavelength <sup>[2]</sup>		λ <sub>d</sub>		637		nm	
Forward Voltage per LED		V <sub>F</sub>		1.8	2.2	V	I <sub>F</sub> = 20 mA
Reverse Breakdown Voltage per LED		V <sub>R</sub>	5	15		V	I <sub>R</sub> = 100 μA
Thermal Resistance LED Junction-to-Pin		Rθ <sub>J-PIN</sub>		250		°C/W/ LED	

### High Efficiency Red HLMP-2300/2600/2900 Series

Parameter	HLMP-	Symbol	Min.	Typ.	Max.	Units	Test Conditions
Luminous Intensity per Lighting Emitting Area <sup>[1]</sup>	2300/2600/2620	$I_V$	6	23		mcd	$I_F = 20 \text{ mA}$
	2350/2635/2655/2670/2950 <sup>[3]</sup>		13	45		mcd	
	2965 <sup>[4]</sup>		19	45		mcd	
	2685		22	80		mcd	
Peak Wavelength		$\lambda_{\text{PEAK}}$		635		nm	
Dominant Wavelength <sup>[2]</sup>		$\lambda_d$		626		nm	
Forward Voltage per LED		$V_F$		2.0	2.6	V	$I_F = 20 \text{ mA}$
Reverse Breakdown Voltage per LED <sup>[5]</sup>		$V_R$	6	15		V	$I_R = 100 \mu\text{A}$
Thermal Resistance LED Junction-to-Pin		$R\theta_{\text{J-PIN}}$		150		°C/W/ LED	

### Yellow HLMP-2400/2700/2950 Series

Parameter	HLMP-	Symbol	Min.	Typ.	Max.	Units	Test Conditions
Luminous Intensity per Lighting Emitting Area <sup>[1]</sup>	2400/2700/2720	$I_V$	6	20		mcd	$I_F = 20 \text{ mA}$
	2450/2735/2755/2770/2950 <sup>[3]</sup>		13	38		mcd	
	2785		26	70		mcd	
Peak Wavelength		$\lambda_{\text{PEAK}}$		583		nm	
Dominant Wavelength <sup>[2]</sup>		$\lambda_d$		585		nm	
Forward Voltage per LED		$V_F$		2.1	2.6	V	$I_F = 20 \text{ mA}$
Reverse Breakdown Voltage per LED <sup>[5]</sup>		$V_R$	6	15		V	$I_R = 100 \mu\text{A}$
Thermal Resistance LED Junction-to-Pin		$R\theta_{\text{J-PIN}}$		150		°C/W/ LED	

LIGHT BARS AND BAR GRAPH ARRAYS

### High Performance Green HLMP-2500/2800/2965 Series

Parameter	HLMP-	Symbol	Min.	Typ.	Max.	Units	Test Conditions
Luminous Intensity per Lighting Emitting Area <sup>[1]</sup>	2500/2800/2820	$I_V$	5	25		mcd	$I_F = 20 \text{ mA}$
	2550/2835/2855/2870		11	50		mcd	
	2965 <sup>[4]</sup>		25	50		mcd	
	2885		22	100		mcd	
Peak Wavelength		$\lambda_{PEAK}$		565		nm	
Dominant Wavelength <sup>[2]</sup>		$\lambda_d$		572		nm	
Forward Voltage per LED		$V_F$		2.2	2.6	V	$I_F = 20 \text{ mA}$
Reverse Breakdown Voltage per LED <sup>[5]</sup>		$V_R$	6	15		V	$I_R = 100 \mu\text{A}$
Thermal Resistance LED Junction-to-Pin		$R\theta_{J-PIN}$		150		$^{\circ}\text{C}/\text{W}/\text{LED}$	

**Notes:**

1. These devices are categorized for luminous intensity. The intensity category is designated by a letter code on the side of the package.
2. The dominant wavelength,  $\lambda_d$ , is derived from the CIE chromaticity diagram and is the single wavelength which defines the color of the device. Yellow and Green devices are categorized for dominant wavelength with the color bin designated by a number code on the side of the package.
3. This is an HER/Yellow bicolor light bar. HER electrical/optical characteristics are shown in the HER table. Yellow electrical/optical characteristics are shown in the Yellow table.
4. This is an HER/Green bicolor light bar. HER electrical/optical characteristics are shown in the HER table. Green electrical/optical characteristics are shown in the Green table.
5. Does not apply to HLMP-2950 or HLMP-2965.



# AlGaAs Red

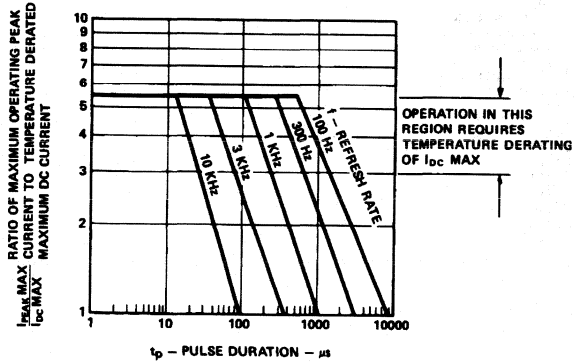

Figure 1. Maximum Allowable Peak Current vs. Pulse Duration.

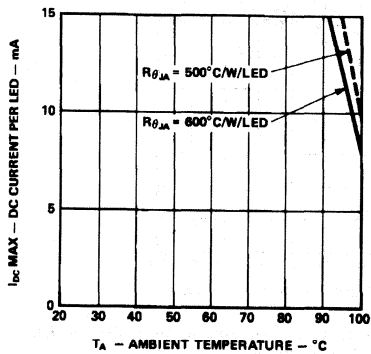

Figure 2. Maximum Allowed DC Current per LED vs. Ambient Temperature,  $T_{MAX} = 110^{\circ}C$ .

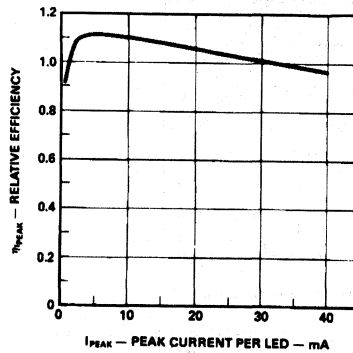

Figure 3. Relative Efficiency (Luminous Intensity per Unit Current) vs. Peak LED Current.

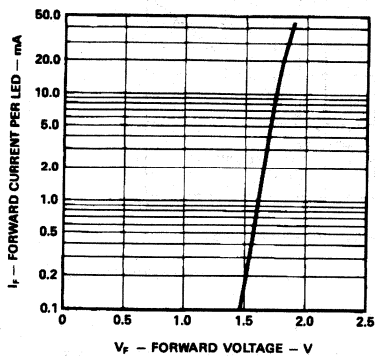

Figure 4. Forward Current vs. Forward Voltage.

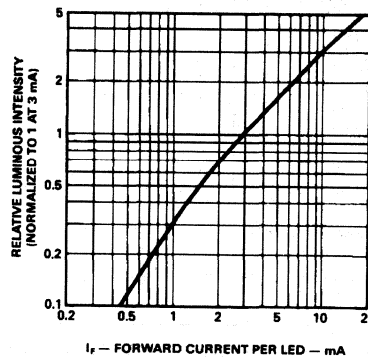

Figure 5. Relative Luminous Intensity vs. DC Forward Current.

LIGHT BARS AND BAR GRAPH ARRAYS

## HER, Yellow, Green

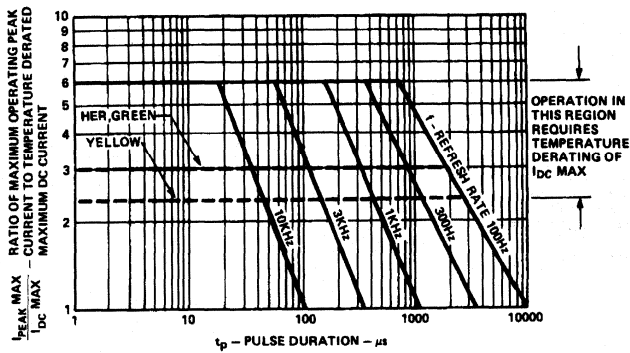

Figure 6. Maximum Allowed Peak Current vs. Pulse Duration.

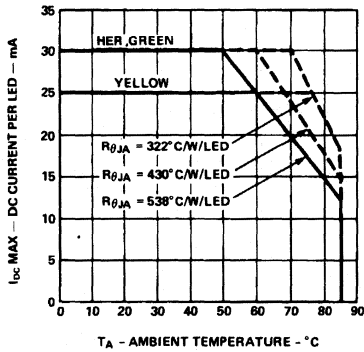

Figure 7. Maximum Allowable DC Current per LED vs. Ambient Temperature,  $T_J$  MAX = 100°C.

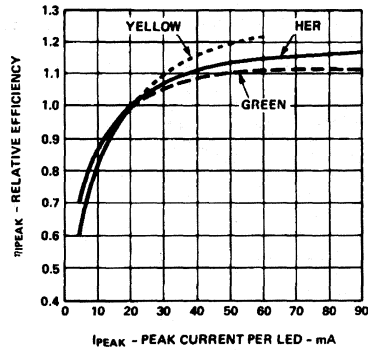

Figure 8. Relative Efficiency (Luminous Intensity per Unit Current) vs. Peak LED Current.

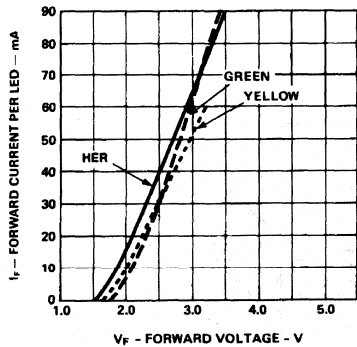

Figure 9. Forward Current vs. Forward Voltage Characteristics.

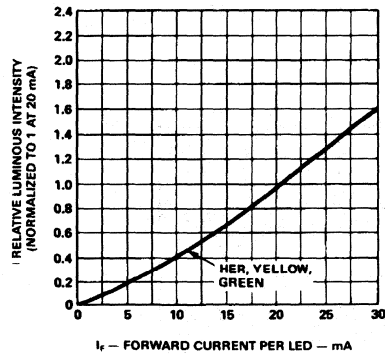

Figure 10. Relative Luminous Intensity vs. DC Forward Current.

For a detailed explanation on the use of data sheet information and recommended soldering procedures, see Application Notes 1005, 1027, and 1031.

## Electrical

These light bars are composed of two, four, or eight light emitting diodes, with the light from each LED optically scattered to form an evenly illuminated light emitting surface.

The anode and cathode of each LED is brought out by separate pins. This universal pinout arrangement allows the LEDs to be connected in three possible configurations: parallel, series, or series parallel. The typical forward voltage values can be scaled from Figures 4 and 9. These values should be used to calculate the current limiting resistor value and typical power consumption. Expected maximum  $V_F$  values for driver circuit design and maximum power dissipation,

may be calculated using the following  $V_{FMAX}$  models:

AlGaAs Red HLCP-X100 series

$$V_{FMAX} = 1.8 V + I_{PEAK} (20 \Omega)$$

For:  $I_{PEAK} \leq 20 \text{ mA}$   
 $V_{FMAX} = 2.0 V + I_{PEAK} (10 \Omega)$   
 For:  $20 \text{ mA} \leq I_{PEAK} \leq 45 \text{ mA}$

HER (HLMP-2300/2600/2900),  
 Yellow (HLMP-2400/2700/2900)  
 and Green (HLMP-2500/2800/  
 2900) series

$$V_{FMAX} = 1.6 + I_{PEAK} (50 \Omega)$$

For:  $5 \text{ mA} \leq I_{PEAK} \leq 20 \text{ mA}$   
 $V_{FMAX} = 1.8 + I_{PEAK} (40 \Omega)$   
 For:  $I_{PEAK} \geq 20 \text{ mA}$

The maximum power dissipation can be calculated for any pulsed or DC drive condition. For DC operation, the maximum power

dissipation is the product of the maximum forward voltage and the maximum forward current. For pulsed operation, the maximum power dissipation is the product of the maximum forward voltage at the peak forward current times the maximum average forward current. Maximum allowable power dissipation for any given ambient temperature and thermal resistance ( $R\theta_{JA}$ ) can be determined by using Figure 2 or 7. The solid line in Figure 2 or 7 ( $R\theta_{JA}$  of 600/538 C/W) represents a typical thermal resistance of a device socketed in a printed circuit board. The dashed lines represent achievable thermal resistances that can be obtained through improved thermal design. Once the maximum allowable power dissipation is determined, the maximum pulsed or DC forward current can be calculated.

## Optical

Size of Light Emitting Area	Surface Area	
	Sq. Metres	Sq. Feet
8.89 mm x 8.89 mm	67.74 x 10 <sup>-6</sup>	729.16 x 10 <sup>-6</sup>
8.89 mm x 3.81 mm	33.87 x 10 <sup>-6</sup>	364.58 x 10 <sup>-6</sup>
8.89 mm x 19.05 mm	135.48 x 10 <sup>-6</sup>	1458.32 x 10 <sup>-6</sup>
3.81 mm x 19.05 mm	72.85 x 10 <sup>-6</sup>	781.25 x 10 <sup>-6</sup>

The radiation pattern for these light bar devices is approximately Lambertian. The luminous sterance may be calculated using one of the two following formulas:

$$L_v \text{ (cd/m}^2\text{)} = \frac{I_v \text{ (cd)}}{A \text{ (m}^2\text{)}}$$

$$L_v \text{ (footlamberts)} = \frac{\pi I_v \text{ (cd)}}{A \text{ (ft}^2\text{)}}$$

Refresh rates of 1 kHz or faster provide the most efficient operation resulting in the maximum possible time average luminous intensity.

The time average luminous intensity may be calculated using the relative efficiency characteristic of Figure 3 or 8,  $\eta_{I_{PEAK}}$  and adjusted for operating ambient temperature. The time average luminous intensity at  $T_A = 25^\circ\text{C}$  is calculated as follows:

$$I_{V \text{ TIME AVG}} = \left[ \frac{I_{AVG}}{I_{TEST}} \right] (\eta_{I_{PEAK}}) (I_v \text{ Data Sheet})$$

where:

$$I_{TEST} = 3 \text{ mA for AlGaAs Red (HLMP-X000 series)}$$

$$20 \text{ mA for HER, Yellow and Green (HLMP-2XXX series)}$$

Example:

For HLMP-2735 series

$$\eta_{I_{PEAK}} = 1.18 \text{ at } I_{PEAK} = 48 \text{ mA}$$

$$I_{V \text{ TIME AVG}} = \left[ \frac{12 \text{ mA}}{20 \text{ mA}} \right] (1.18) (35 \text{ mcd})$$

$$= 25 \text{ mcd}$$

The time average luminous intensity may be adjusted for operating ambient temperature by the following exponential equation:

$$I_v(T_A) = I_v(25^\circ\text{C})e^{[K(T_A - 25^\circ\text{C})]}$$

Color	K
AlGaAs Red	-0.0095/°C
HER	-0.0131/°C
Yellow	-0.0112/°C
Green	-0.0104/°C

Example:

$$I_v(80^\circ\text{C}) = (25 \text{ mcd})e^{[-0.0112(80-25)]}$$

$$= 14 \text{ mcd.}$$

### Mechanical

These light bar devices may be operated in ambient temperatures above +60°C without derating when installed in a PC board configuration that provides a thermal resistance pin to ambient value less than 280°C/W/LED. See Figure 2 or 7 to determine the maximum allowed thermal resistance for the PC board,  $R_{\theta_{PC-A}}$ , which will permit nonderated operation in a given ambient temperature.

To optimize device optical performance, specially developed plastics are used which restrict the solvents that may be used for cleaning. It is recommended that only mixtures of Freon (F113) and alcohol be used for vapor cleaning processes, with an

immersion time in the vapors of less than two (2) minutes maximum. Some suggested vapor cleaning solvents are Freon TE, Genesolv DES, Arklone A or K. A 60°C (140°F) water cleaning process may also be used, which includes a neutralizer rinse (3% ammonia solution or equivalent), a surfactant rinse (1% detergent solution or equivalent), a hot water rinse and a thorough air dry. Room temperature cleaning may be accomplished with Freon T-E35 or T-P35, Ethanol, Isopropanol or water with a mild detergent.

For further information on soldering LEDs please refer to Application Note 1027.

# Single Chip LED Light Bar

## Technical Data

**HLMP-T200**  
**HLMP-T300**  
**HLMP-T400**  
**HLMP-T500**

LIGHT BARS AND  
BAR GRAPH ARRAYS

### Features

- Flat Rectangular Light Emitting Surface
- Choice of 4 Bright Colors
- Excellent On/Off Contrast
- Ideal as Flush Mounted Panel Indicators
- Long Life: Solid State Reliability
- Solder Coated Leads

### Applications

- Bar Graphs
- Front Panel Status Indicators
- Telecommunications Indicators

- Push Button Illumination
- PC Board Identifiers
- Business Machine Message Annunciators

### Description

The HLMP-T200/-T300/-T400/-T500 light bars are rectangular light sources designed for a variety of applications where this shape and a high sterance are desired. These light bars consist of a rectangular plastic case around an epoxy encapsulated LED lamp. The encapsulant is tinted to match the color of the

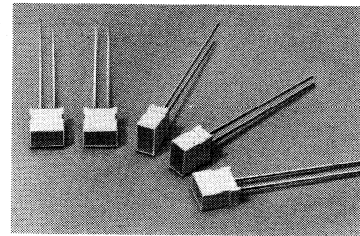

emitted light. The flat top surface is exceptionally uniform in light emission and the plastic case eliminates light leakage from the sides of the device.

### Package Dimensions

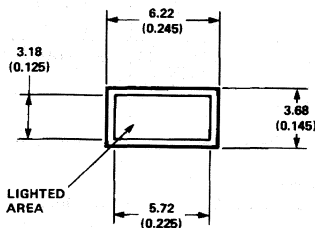

NOTES:  
1. DIMENSIONS ARE IN MILLIMETRES (INCHES).  
2. TOLERANCES ARE  $\pm 0.25$  mm ( $\pm 0.010$  INCH) UNLESS OTHERWISE NOTED.

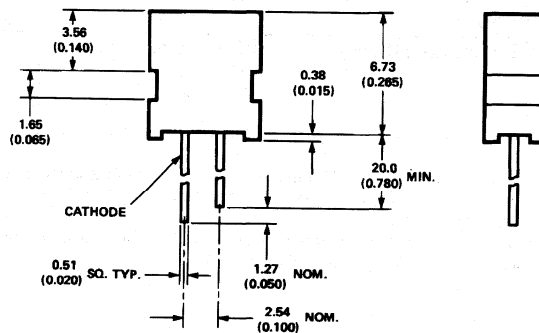

### Electrical/Optical Characteristics at $T_A = 25^\circ\text{C}$

Symbol	Description	Device HLMP-	Min.	Typ.	Max.	Units	Test Conditions
$I_V$	Luminous Intensity	High Efficiency Red T200	3.0	4.8		mcd	$I_F = 20\text{ mA}$
		Orange T400	3.0	4.8			
		Yellow T300	3.0	4.8			
		Green T500	3.0	6.0			
$2\theta_{1/2}$	Included Angle Between Half Luminous Intensity Points	All		100		Deg.	$I_F = 20\text{ mA}$ See Note 1
$\lambda_{\text{PEAK}}$	Peak Wavelength	High Efficiency Red Orange Yellow Green		635 612 583 565		nm	Measurement at Peak
$\lambda_d$	Dominant Wavelength	High Efficiency Red Orange Yellow Green		626 608 585 569		nm	See Note 2
$\tau_s$	Speed of Response	High Efficiency Red Orange Yellow Green		350 350 390 870		ns	
C	Capacitance	High Efficiency Red Orange Yellow Green		4 4 8 11		pF	$V_F = 0;$ $f = 1\text{ MHz}$
$R\theta_{\text{JC}}$	Thermal Resistance	All		260		$^\circ\text{C/W}$	Junction to Cathode Lead at Seating Plane
$V_F$	Forward Voltage	HER/Orange Yellow Green	1.5 1.5 1.6	2.2 2.2 2.3	2.6 2.6 2.6	V	$I_F = 20\text{ mA}$
$V_R$	Reverse Breakdown Voltage	All	5.0			V	$I_R = 100\ \mu\text{A}$
$\eta_V$	Luminous Efficacy	High Efficiency Red Orange Yellow Green		145 262 500 595		$\frac{\text{lumens}}{\text{Watt}}$	See Note 3

**Notes:**

- $\theta_{1/2}$  is the off-axis angle at which the luminous intensity is half the axial luminous intensity.
- The dominant wavelength,  $\lambda_d$ , is derived from the CIE chromaticity diagram and represents the single wavelength which defines the color of the device.
- Radiant intensity,  $I_e$ , in watts/steradian, may be found from the equation  $I_e = I_V/\eta_V$ , where  $I_V$  is the luminous intensity in candelas and  $\eta_V$  is the luminous efficacy in lumens/watt.

**Characteristics at  $T_A = 25^\circ\text{C}$**

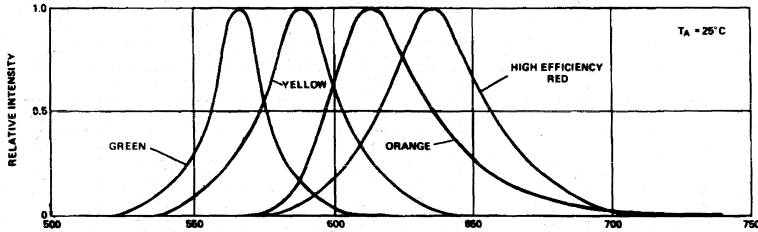

Figure 1. Relative Intensity vs. Wavelength.

**High Efficiency Red, Orange, Yellow, and Green Light Bars**

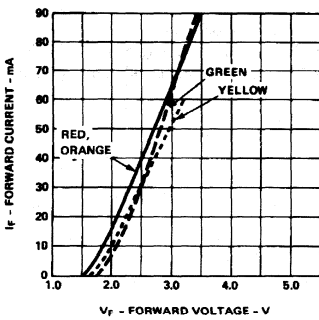

Figure 2. Forward Current vs. Forward Voltage Characteristics.

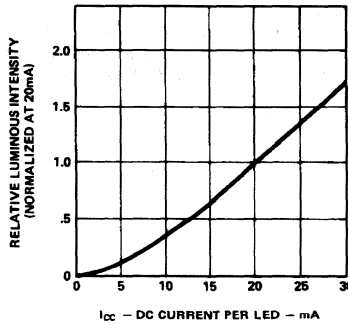

Figure 3. Relative Luminous Intensity vs. DC Forward Current.

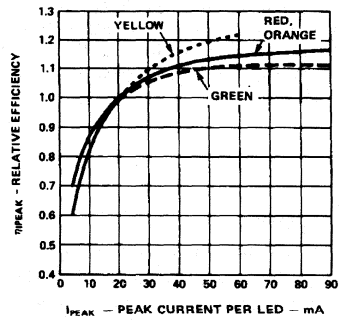

Figure 4. Relative Efficiency (Luminous Intensity per Unit Current) vs. LED Peak Current.

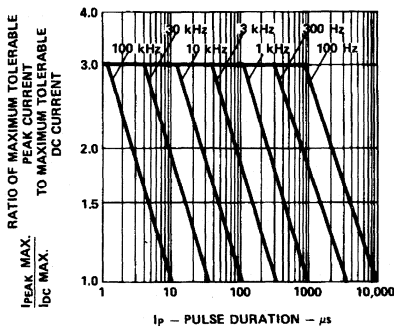

Figure 5. Maximum Tolerable Peak Current vs. Pulse Duration. ( $I_{DC\ MAX}$  as per MAX Ratings).

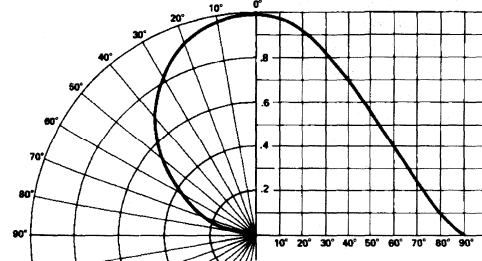

Figure 6. Relative Luminous Intensity vs. Angular Displacement.

### Absolute Maximum Ratings at $T_A = 25^\circ\text{C}$

Parameter	High Efficiency Red/ Orange	Yellow	Green	Units
Peak Forward Current	90	60	90	mA
Average Forward Current <sup>[1]</sup>	25	20	25	mA
DC Current <sup>[2]</sup>	30	20	30	mA
Power Dissipation	88	64	88	mW
LED Junction Temperature	110			$^\circ\text{C}$
Operating Temperature Range	-40 to +85	-40 to +85	-20 to +85	$^\circ\text{C}$
Storage Temperature Range	-55 to +100	-55 to +100	-55 to +100	
Reverse Voltage ( $I_R = 100 \mu\text{A}$ )	5			V
Transient Forward Current <sup>[3]</sup> (10 $\mu\text{sec}$ Pulse)	500			mA
Lead Soldering Temperature [1.6 mm (0.063 in.) below seating plane]	260 $^\circ\text{C}$ for 3 seconds			

**Notes:**

1. See Figure 5 to establish pulsed operating conditions.
2. For Red, Orange, and Green derate linearly from 50 $^\circ\text{C}$  at 0.5 mA/ $^\circ\text{C}$ . For Yellow derate linearly from 50 $^\circ\text{C}$  at 0.34 mA/ $^\circ\text{C}$ .
3. The transient peak current is the maximum non-recurring peak current that can be applied to the device without damaging the LED die and wirebond. It is not recommended that the device be operated at peak currents beyond the peak forward current listed in the Absolute Maximum Ratings.

### Optical

The radiation pattern for these light bar devices is approximately Lambertian. The luminous sterance may be calculated using one of the two following formulas:

$$L_V (\text{cd/m}^2) = \frac{I_V (\text{cd})}{A (\text{m}^2)}$$

$$L_V (\text{footlamberts}) = \frac{\pi I_V (\text{cd})}{A (\text{ft}^2)}$$

$$\begin{aligned} \text{Size of light emitting area (A)} \\ &= 3.18 \text{ mm} \times 5.72 \text{ mm} \\ &= 18.19 \times 10^{-6} \text{ m}^2 \\ &= 195.8 \times 10^{-6} \text{ ft}^2 \end{aligned}$$



# 10-Element Bar Graph Array

## Technical Data

**HLCP-J100**  
**HDSP-4820**  
**HDSP-4830**  
**HDSP-4832**

### Features

- Custom Multicolor Array Capability
- Matched LEDs for Uniform Appearance
- End Stackable
- Package Interlock Ensures Correct Alignment
- Low Profile Package
- Rugged Construction
- Large, Easily Recognizable Segments
- High ON-OFF Contrast, Segment to Segment
- Wide Viewing Angle
- Categorized for Luminous Intensity
- HDSP-4832/4836/4840/4850 Categorized for Dominant Wavelength
- HLCP-J100 Operates at Low Current  
Typical Intensity of 1.0 mcd at 1 mA Drive Current

### Applications

- Industrial Controls
- Instrumentation
- Office Equipment
- Computer Peripherals
- Consumer Products

### Description

These 10-element LED arrays are designed to display information in easily recognizable bar graph form. The packages are end stackable and therefore capable of displaying long strings of information. Use of these bar graph arrays eliminates the alignment, intensity, and color matching problems associated with discrete LEDs. The HDSP-4820/4830/4840/4850 and HLCP-J100 each contain LEDs of one color. The HDSP-4832/4836 are multicolor arrays with High Efficiency Red, Yellow, and High Performance Green LEDs in a single package.

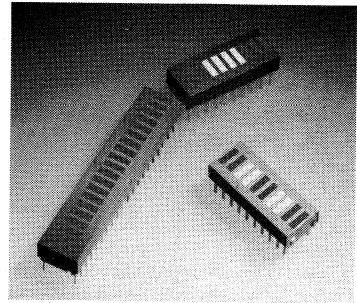

CUSTOM MULTICOLOR ARRAYS ARE AVAILABLE WITH MINIMUM DELIVERY REQUIREMENTS. CONTACT YOUR LOCAL DISTRIBUTOR OR HP SALES OFFICE FOR DETAILS.

### Package Dimensions

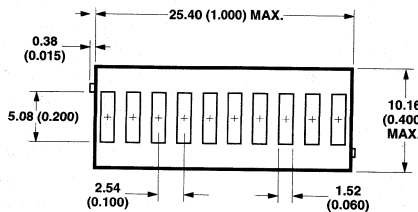

1. DIMENSIONS IN MILLIMETERS (INCHES).
2. ALL UNTOLERANCED DIMENSIONS FOR REFERENCE ONLY.
3. HDSP-4832/-4836/-4840/-4850 ONLY.

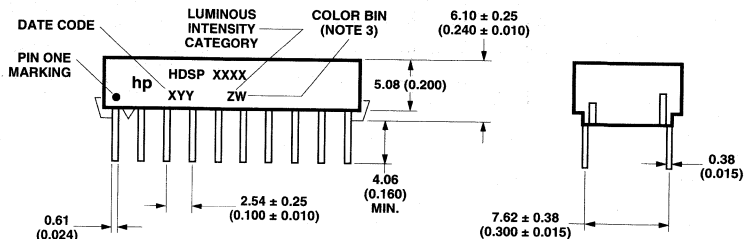

## Absolute Maximum Ratings<sup>[7]</sup>

Parameter	Red HDSP-4820	AlGaAs Red HLCP-J100	HER HDSP-4830	Yellow HDSP-4840	Green HDSP-4850
Average Power Dissipation per LED ( $T_A = 25^\circ\text{C}$ )	63 mW	37 mW	87 mW	50 mW	105 mW
Peak Forward Current per LED	150 mA <sup>[1]</sup>	45 mA <sup>[2]</sup>	90 mA <sup>[3]</sup>	60 mA <sup>[3]</sup>	90 mA <sup>[3]</sup>
DC Forward Current per LED	30 mA <sup>[4]</sup>	15 mA <sup>[4]</sup>	30 mA <sup>[5]</sup>	20 mA <sup>[5]</sup>	30 mA <sup>[5]</sup>
Operating Temperature Range	-40°C to +85°C	-20°C to +100°C	-40°C to +85°C		-20°C to +85°C
Storage Temperature Range	-40°C to +85°C	-55°C to +100°C	-40°C to +85°C		
Reverse Voltage per LED	3.0 V	5.0 V	3.0 V		
Lead Soldering Temperature (1.59 mm (1/16 inch) below seating plane) <sup>[6]</sup>	260°C for 3 seconds <sup>[8]</sup>				

### Notes:

- See Figure 1 to establish pulsed operating conditions. Maximum pulse width is 1.5 ms.
- See Figure 2 to establish pulsed operating conditions. Maximum pulse width is 1.5 ms.
- See Figure 8 to establish pulsed operating conditions. Maximum pulse width is 2 ms.
- Derate maximum DC current for Red above  $T_A = 62^\circ\text{C}$  at 0.79 mA/°C, and AlGaAs Red above  $T_A = 91^\circ\text{C}$  at 0.8 mA/°C. See Figure 3.
- Derate maximum DC current for HER above  $T_A = 48^\circ\text{C}$  at 0.58 mA/°C, Yellow above  $T_A = 70^\circ\text{C}$  at 0.66 mA/°C, and Green above  $T_A = 37^\circ\text{C}$  at 0.48 mA/°C. See Figure 9.
- Clean only in water, isopropanol, ethanol, Freon TF or TE (or equivalent), or Genesolve DI-15 (or equivalent).
- Absolute maximum ratings for HER, Yellow, and Green elements of the multicolor arrays are identical to the HDSP-4830/4840/4850 maximum ratings.
- Maximum tolerable component side temperature is 134°C during solder process.

## Internal Circuit Diagram

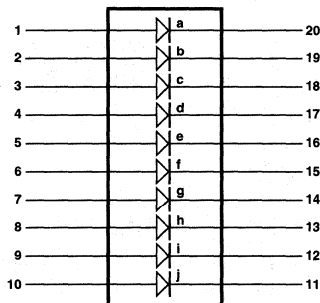

Pin	Function	Pin	Function
1	Anode a	11	Cathode j
2	Anode b	12	Cathode i
3	Anode c	13	Cathode h
4	Anode d	14	Cathode g
5	Anode e	15	Cathode f
6	Anode f	16	Cathode e
7	Anode g	17	Cathode d
8	Anode h	18	Cathode c
9	Anode i	19	Cathode b
10	Anode j	20	Cathode a

### Multicolor Array Segment Colors

Segment	HDSP-4832 Segment Color	HDSP-4836 Segment Color
a	HER	HER
b	HER	HER
c	HER	Yellow
d	Yellow	Yellow
e	Yellow	Green
f	Yellow	Green
g	Yellow	Yellow
h	Green	Yellow
i	Green	HER
j	Green	HER

### Electrical/Optical Characteristics at $T_A = 25^\circ\text{C}$ <sup>[4]</sup>

#### Red HDSP-4820

Parameter	Symbol	Min.	Typ.	Max.	Units	Test Conditions
Luminous Intensity per LED (Unit Average) <sup>[1]</sup>	$I_V$	610	1250		$\mu\text{cd}$	$I_F = 20 \text{ mA}$
Peak Wavelength	$\lambda_{\text{PEAK}}$		655		nm	
Dominant Wavelength <sup>[2]</sup>	$\lambda_d$		645		nm	
Forward Voltage per LED	$V_F$		1.6	2.0	V	$I_F = 20 \text{ mA}$
Reverse Voltage per LED <sup>[5]</sup>	$V_R$	3	12		V	$I_R = 100 \mu\text{A}$
Temperature Coefficient $V_F$ per LED	$\Delta V_F / ^\circ\text{C}$		-2.0		mV/ $^\circ\text{C}$	
Thermal Resistance LED Junction-to-Pin	$R\theta_{\text{J-PIN}}$		300		$^\circ\text{C/W/LED}$	

#### AlGaAs Red HLCP-J100

Parameter	Symbol	Min.	Typ.	Max.	Units	Test Conditions
Luminous Intensity per LED (Unit Average) <sup>[1]</sup>	$I_V$	600	1000		$\mu\text{cd}$	$I_F = 1 \text{ mA}$
			5200			$I_F = 20 \text{ mA Pk};$ 1 of 4 Duty Factor
Peak Wavelength	$\lambda_{\text{PEAK}}$		645		nm	
Dominant Wavelength <sup>[2]</sup>	$\lambda_d$		637		nm	
Forward Voltage per LED	$V_F$		1.6		V	$I_F = 1 \text{ mA}$
			1.8	2.2		$I_F = 20 \text{ mA}$
Reverse Voltage per LED <sup>[5]</sup>	$V_R$	5	15		V	$I_R = 100 \mu\text{A}$
Temperature Coefficient $V_F$ per LED	$\Delta V_F / ^\circ\text{C}$		-2.0		mV/ $^\circ\text{C}$	
Thermal Resistance LED Junction-to-Pin	$R\theta_{\text{J-PIN}}$		300		$^\circ\text{C/W/LED}$	

### High Efficiency Red HDSP-4830

Parameter	Symbol	Min.	Typ.	Max.	Units	Test Conditions
Luminous Intensity per LED (Unit Average) <sup>[1,4]</sup>	$I_V$	900	3500		$\mu\text{cd}$	$I_F = 10 \text{ mA}$
Peak Wavelength	$\lambda_{\text{PEAK}}$		635		nm	
Dominant Wavelength <sup>[2]</sup>	$\lambda_d$		626		nm	
Forward Voltage per LED	$V_F$		2.1	2.5	V	$I_F = 20 \text{ mA}$
Reverse Voltage per LED <sup>[5]</sup>	$V_R$	3	30		V	$I_R = 100 \mu\text{A}$
Temperature Coefficient $V_F$ per LED	$\Delta V_F / ^\circ\text{C}$		-2.0		mV/ $^\circ\text{C}$	
Thermal Resistance LED Junction-to-Pin	$R\theta_{\text{J-PIN}}$		300		$^\circ\text{C/W/LED}$	

### Yellow HDSP-4840

Parameter	Symbol	Min.	Typ.	Max.	Units	Test Conditions
Luminous Intensity per LED (Unit Average) <sup>[1,4]</sup>	$I_V$	600	1900		$\mu\text{cd}$	$I_F = 10 \text{ mA}$
Peak Wavelength	$\lambda_{\text{PEAK}}$		583		nm	
Dominant Wavelength <sup>[2,3]</sup>	$\lambda_d$	581	585	592	nm	
Forward Voltage per LED	$V_F$		2.2	2.5	V	$I_F = 20 \text{ mA}$
Reverse Voltage per LED <sup>[5]</sup>	$V_R$	3	40		V	$I_R = 100 \mu\text{A}$
Temperature Coefficient $V_F$ per LED	$\Delta V_F / ^\circ\text{C}$		-2.0		mV/ $^\circ\text{C}$	
Thermal Resistance LED Junction-to-Pin	$R\theta_{\text{J-PIN}}$		300		$^\circ\text{C/W/LED}$	

### Green HDSP-4850

Parameter	Symbol	Min.	Typ.	Max.	Units	Test Conditions
Luminous Intensity per LED (Unit Average) <sup>[1,4]</sup>	$I_V$	600	1900		$\mu\text{cd}$	$I_F = 10 \text{ mA}$
Peak Wavelength	$\lambda_{\text{PEAK}}$		566		nm	
Dominant Wavelength <sup>[2,3]</sup>	$\lambda_d$		571	577	nm	
Forward Voltage per LED	$V_F$		2.1	2.5	V	$I_F = 10 \text{ mA}$
Reverse Voltage per LED <sup>[5]</sup>	$V_R$	3	50		V	$I_R = 100 \mu\text{A}$
Temperature Coefficient $V_F$ per LED	$\Delta V_F / ^\circ\text{C}$		-2.0		mV/ $^\circ\text{C}$	
Thermal Resistance LED Junction-to-Pin	$R\theta_{\text{J-PIN}}$		300		$^\circ\text{C/W/LED}$	

#### Notes:

1. The bar graph arrays are categorized for luminous intensity. The category is designated by a letter located on the side of the package.
2. The dominant wavelength,  $\lambda_d$ , is derived from the CIE chromaticity diagram and is that single wavelength which defines the color of the device.
3. The HDSP-4832/-4836/-4840/-4850 bar graph arrays are categorized by dominant wavelength with the category designated by a number adjacent to the intensity category letter. Only the yellow elements of the HDSP-4832/-4836 are categorized for color.
4. Electrical/optical characteristics of the High-Efficiency Red elements of the HDSP-4832/-4836 are identical to the HDSP-4830 characteristics. Characteristics of Yellow elements of the HDSP-4832/-4836 are identical to the HDSP-4840. Characteristics of Green elements of the HDSP-4832/-4836 are identical to the HDSP-4850.
5. Reverse voltage per LED should be limited to 3.0 V max. for the HDSP-4820/-4830/-4840/-4850/-4832/-4836 and 5.0 V max. for the HLCP-J100.

## Red, AlGaAs Red

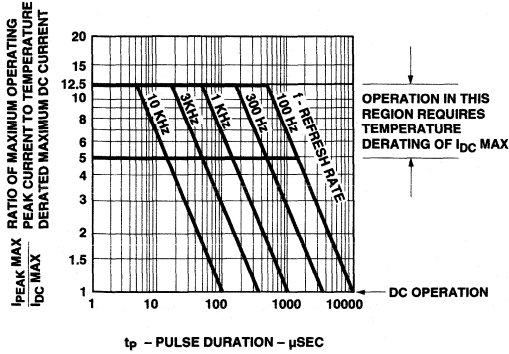

Figure 1. Maximum Tolerable Peak Current vs. Pulse Duration - Red.

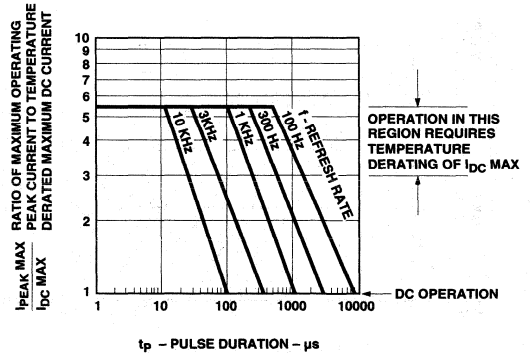

Figure 2. Maximum Tolerable Peak Current vs. Pulse Duration - AlGaAs Red.

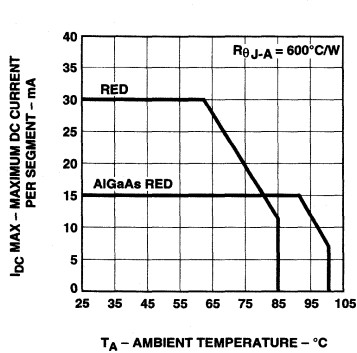

Figure 3. Maximum Allowable DC Current vs. Ambient Temperature.  $T_{JMAX} = 100^{\circ}\text{C}$  for Red and  $T_{JMAX} = 110^{\circ}\text{C}$  for AlGaAs Red.

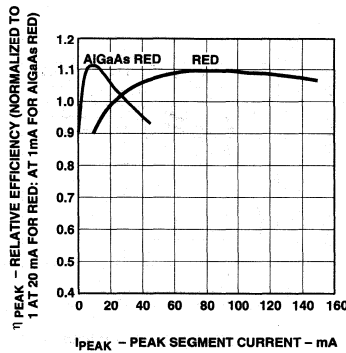

Figure 4. Relative Efficiency (Luminous Intensity per Unit Current) vs. Peak Current.

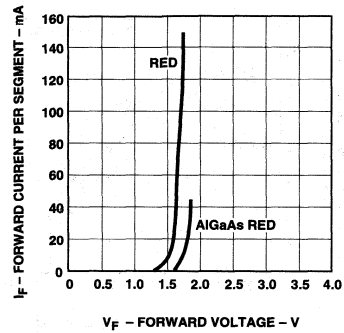

Figure 5. Forward Current vs. Forward Voltage.

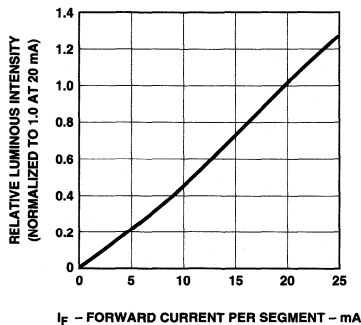

Figure 6. Relative Luminous Intensity vs. DC Forward Current - Red.

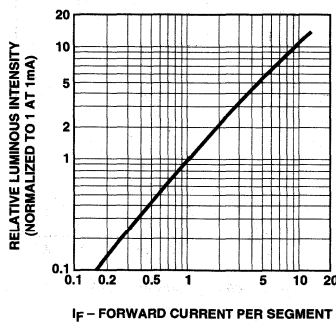

Figure 7. Relative Luminous Intensity vs. DC Forward Current - AlGaAs.

For a Detailed Explanation on the Use of Data Sheet Information and Recommended Soldering Procedures, See Application Note 1005.

# HER, Yellow, Green

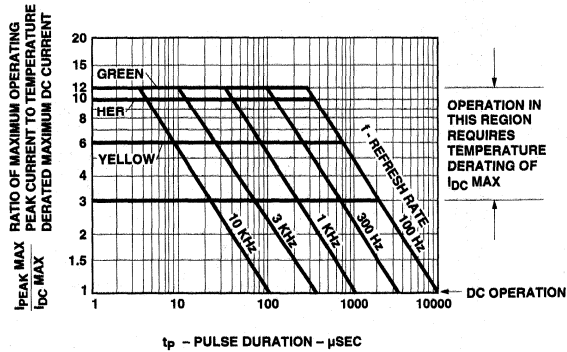

Figure 8. Maximum Tolerable Peak Current vs. Pulse Duration - HER/Yellow/Green.

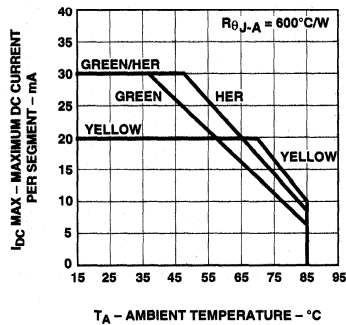

Figure 9. Maximum Allowable DC Current vs. Ambient Temperature.  $T_{jMAX} = 100^{\circ}C$ .

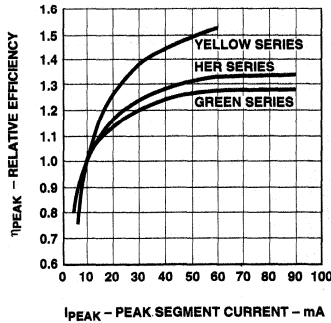

Figure 10. Relative Efficiency (Luminous Intensity per Unit Current) vs. Peak Current.

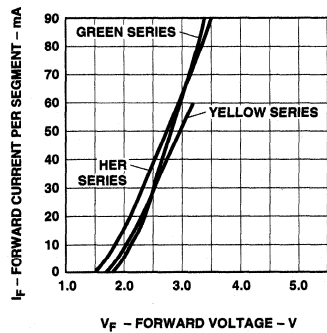

Figure 11. Forward Current vs. Forward Voltage.

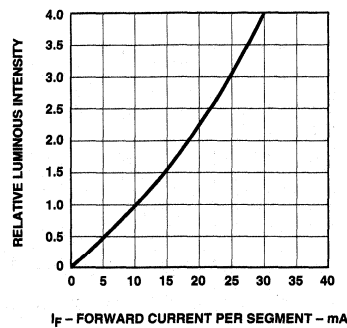

Figure 12. Relative Luminous Intensity vs. DC Forward Current.

For a Detailed Explanation on the Use of Data Sheet Information and Recommended Soldering Procedures, See Application Note 1005.

### Electrical/Optical

These versatile bar graph arrays are composed of ten light emitting diodes. The light from each LED is optically stretched to form individual elements. The Red (HDSP-4820) bar graph array LEDs use a p-n junction diffused into a GaAsP epitaxial layer on a GaAs substrate. The AlGaAs Red (HLCP-J100) bar graph array LEDs use double heterojunction AlGaAs on a GaAs substrate. HER (HDSP-4830) and Yellow (HDSP-4840) bar graph array LEDs use a GaAsP epitaxial layer on a GaP substrate. Green (HDSP-4850) bar graph array LEDs use liquid phase GaP epitaxial layer on a GaP substrate. The multicolor bar graph arrays (HDSP-4832/4836) have HER, Yellow, and Green LEDs in one package.

These displays are designed for strobed operation. The typical forward voltage values can be scaled from Figures 5 and 11. These values should be used to calculate the current limiting resistor value and typical power consumption. Expected maximum  $V_F$  values for driver circuit design and maximum power dissipation may be calculated using the  $V_{FMAX}$  models:

Standard Red HDSP-4820 series  
 $V_{FMAX} = 1.8 \text{ V} + I_{Peak} (10 \Omega)$   
 For:  $I_{Peak} \geq 5 \text{ mA}$

AlGaAs Red HLCP-J100 series  
 $V_{FMAX} = 1.8 \text{ V} + I_{Peak} (20 \Omega)$   
 For:  $I_{Peak} \leq 20 \text{ mA}$   
 $V_{FMAX} = 2.0 \text{ V} + I_{Peak} (10 \Omega)$   
 For:  $I_{Peak} \geq 20 \text{ mA}$

HER (HDSP-4830) and Yellow (HDSP-4840) series  
 $V_{FMAX} = 1.6 + I_{Peak} (45 \Omega)$   
 For:  $5 \text{ mA} \leq I_{Peak} \leq 20 \text{ mA}$   
 $V_{FMAX} = 1.75 + I_{Peak} (38 \Omega)$   
 For:  $I_{Peak} \geq 20 \text{ mA}$

Green (HDSP-4850) series  
 $V_{FMAX} = 2.0 + I_{Peak} (50 \Omega)$   
 For:  $I_{Peak} > 5 \text{ mA}$

Figures 4 and 10 allow the designer to calculate the luminous intensity at different peak and average currents. The following equation calculates intensity at different peak and average currents:

$$I_{VAVG} = (I_{FAVG}/I_{FAVG \text{ DATA SHEET}})\eta_{peak}(I_{V \text{ DATA SHEET}})$$

Where:

$I_{VAVG}$  is the calculated time averaged luminous intensity resulting from  $I_{FAVG}$ .

$I_{FAVG}$  is the desired time averaged LED current.

$I_{FAVG \text{ DATA SHEET}}$  is the data sheet test current for  $I_{V \text{ DATA SHEET}}$ .

$\eta_{peak}$  is the relative efficiency at the peak current, scaled from Figure 4 or 10.

$I_{V \text{ DATA SHEET}}$  is the data sheet luminous intensity, resulting from  $I_{FAVG \text{ DATA SHEET}}$ .

For example, what is the luminous intensity of an HDSP-4830 driven at 50 mA peak 1/5 duty factor?

$$I_{FAVG} = (50 \text{ mA})(0.2) = 10 \text{ mA}$$

$$I_{FAVG \text{ DATA SHEET}} = 10 \text{ mA}$$

$$\eta_{peak} = 1.3$$

$$I_{V \text{ DATA SHEET}} = 3500 \mu\text{cd}$$

Therefore

$$I_{VAVG} = (10 \text{ mA}/10 \text{ mA})(1.3)(3500 \mu\text{cd}) = 4550 \mu\text{cd}$$

# Panel and Legend Mounts for LED Light Bars

## Technical Data

**HLMP-2598**  
**HLMP-2599**  
**HLMP-2898**  
**HLMP-2899**

### Features



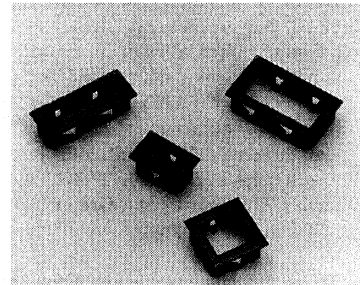

- Firmly Mounts Light Bars in Panels
- Holds Legends for Front Panel or PC Board Applications<sup>[1]</sup>
- One Piece, Snap-in Assembly
- Matte Black Bezel Design Enhances Panel Appearance
- Four Sizes Available
- May Be Installed in a Wide Range of Panel Thicknesses
- Panel Hole Easily Punched or Milled

### Description

This series of black plastic bezel mounts is designed to install Hewlett-Packard Light Bars in instrument panels ranging in thickness from 1.52 mm (0.060 inch) to 3.18 mm (0.125 inch). A space has been provided for holding a 0.13 mm (0.005 inch) film legend over the light emitting surface of the light bar module.



### Selection Guide

Panel and Legend Mount Part No.	Corresponding Light Bar Module Part No.		Panel Hole Installation Dimensions <sup>[2]</sup>	Package Outline	
	HLCP-	HLMP-			
2598	B100	2350, 2450, 2550	7.62 mm (0.300 inch) x 22.86 mm (0.900 inch)		B
2599	A100	2300, 2400, 2500	7.62 mm (0.300 inch) x 12.70 mm (0.500 inch)		A
2898	D100 C100	2600, 2700, 2800	12.70 mm (0.500 inch) x 12.70 mm (0.500 inch)		C
		2655, 2755, 2855 2950, 2965, 2980			
2899	E100	2620, 2720, 2820	12.70 mm (0.500 inch) x 22.86 mm (0.900 inch)		D
	F100	2635, 2735, 2835			
	G100	2670, 2770, 2870			
	H100	2685, 2785, 2885			

#### Notes:

1. Application Note 1012 addresses legend fabrication options.
2. Allowed hole tolerance: +0.00 mm, -0.13 mm (+0.000 inch, -0.005 inch). Permitted radius: 1.60 mm (0.063 inch).



## Package Dimensions

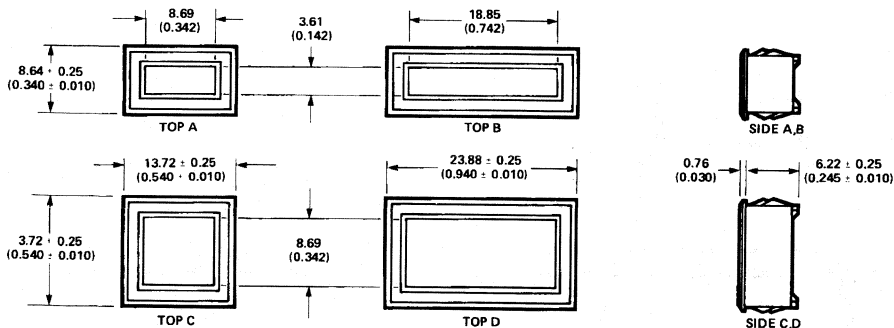

NOTES: 1. DIMENSIONS IN MILLIMETRES (INCHES)  
2. UNTOLERANCED DIMENSIONS ARE FOR REFERENCE ONLY.

## Mounting Instructions

1. Mill<sup>[3]</sup> or punch a hole in the panel. Deburr, but do not chamfer, the edges of the hole.
2. Place the front of the mount against a solid, flat surface. A film legend with outside dimensions equal to the outside dimensions of the light bar may be placed in the mount or on the light bar light emitting surface. Press the light bar into the mount until the tabs snap over the back of the light bar<sup>[4]</sup>. When inserting the HLMP-2898, align the notched sides of the light bar with the mount sides which do not have the tabs. (See Figure 1.)

3. Applying even pressure to the top of the mount, press the entire assembly into the hole from the front of the panel<sup>[5]</sup>. (See Figure 2.)

Note: For thinner panels, the mount may be pressed into the panel first, then the light bar may be pressed into the mount from the back side of the panel.

## Suggested Punch Sources

Hole punches may be ordered from one of the following sources:

Danly Machine Corporation  
Punchrite Division  
15400 Brookpark Road  
Cleveland, OH 44135  
(216) 267-1444

Ring Division  
The Producto Machine Company  
Jamestown, NY 14701  
(800) 828-2216

Porter Precision Products  
Company  
12522 Lakeland Road  
Santa Fe Springs, CA 90670  
(213) 946-1531

Di-Acro Division  
Houdaille Industries  
800 Jefferson Street  
Lake City, MN 55041  
(612) 345-4571

## Notes:

3. A 3.18 mm (0.125 inch) diameter mill may be used.
4. Repetitive insertion of the light bar into mount may cause damage to the mount.
5. Repetitive insertion of the mount into the panel will degrade the retention force of the mount.

**Installation Sketches**

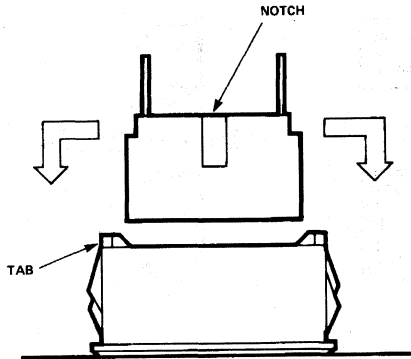

**Figure 1. Installation of a Light Bar into a Panel Mount.**

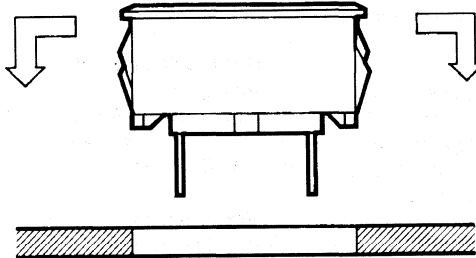

**Figure 2. Installation of the Light Bar/Panel Mount Assembly into a Front Panel.**

# LED Light Bars Standard Options

## Technical Data

LIGHT BARS AND  
BAR GRAPH ARRAYS

### Option S02, S22

#### Description

Due to applications that require tightly matched devices, Hewlett-Packard has developed several standard options to service these requirements.

Option S02 consists of devices which are selected to two Iv categories. All color bins of the base parts (yellow and green devices) fulfill the color requirements of these products.

Option S22 consists of devices which are selected to two Iv categories and two color bin categories.

#### Ordering Information

To order Light Bars with these standard options, order the base part number and add the option code (S02, S22). For any base part number that does not appear in the following lists, please consult your local Hewlett-Packard representative or your local franchise distributor.

#### Option S02 - Partial base part number list:

HDSP-4820	HLMP-2600
HDSP-4830	HLMP-2620
HDSP-4840	HLMP-2635
HDSP-4850	HLMP-2655
HLCP-A100	HLMP-2670
HLCP-B100	HLMP-2685
HLCP-C100	HLMP-2700
HLCP-D100	HLMP-2720
HLCP-E100	HLMP-2735
HLCP-F100	HLMP-2755
HLCP-G100	HLMP-2770
HLCP-H100	HLMP-2785
HLMP-2300	HLMP-2800
HLMP-2316	HLMP-2820
HLMP-2350	HLMP-2835
HLMP-2400	HLMP-2855
HLMP-2450	HLMP-2870
HLMP-2500	HLMP-2885
HLMP-2550	HLMP-2950

#### OPTION S22 - Partial base part number list:

HLMP-2400	HLMP-2755
HLMP-2500	HLMP-2785
HLMP-2855	HLMP-2885
HLMP-2965	HLMP-2550
HLMP-2450	HDSP-4840
HLMP-2735	HDSP-4850



# LED Displays

- Seven Segment Numeric
- Alphanumeric
- Hexadecimal
- Glass/Ceramic

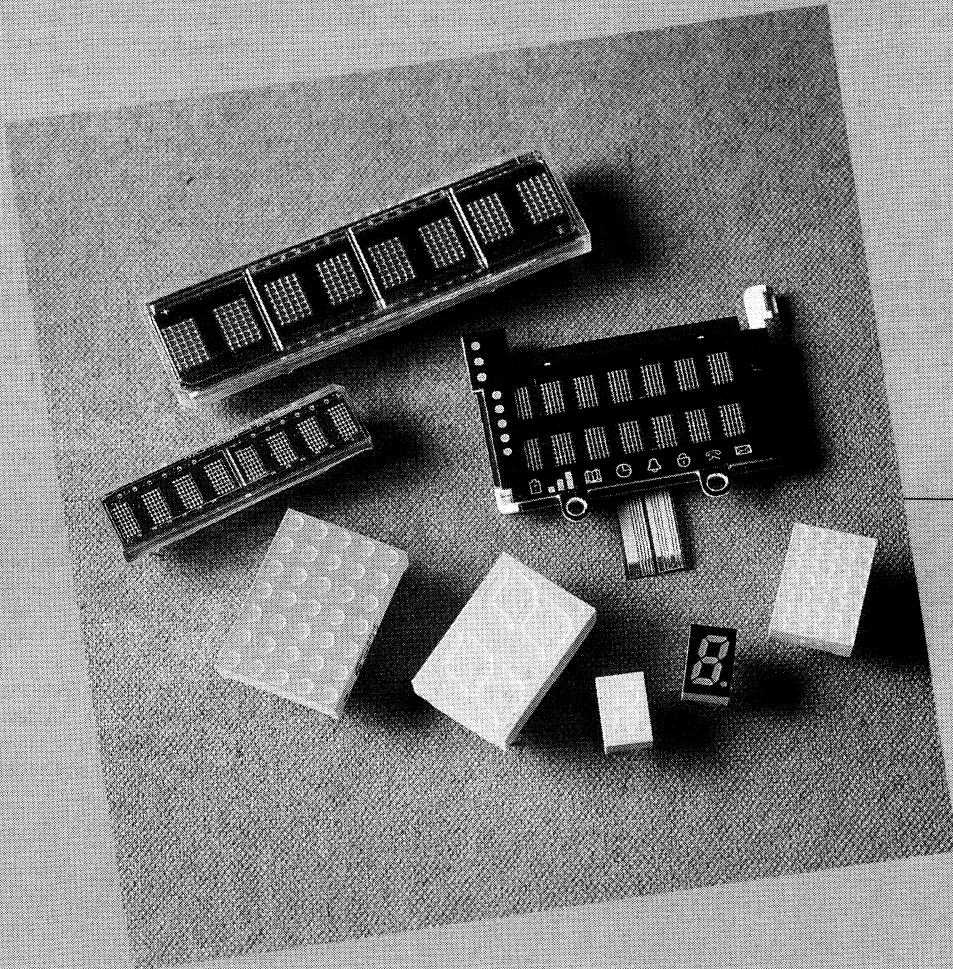

---

## LED Displays

Hewlett-Packard's line of LED displays answers all the needs of the designer. From small alphanumeric displays to low cost numeric displays and large dot matrix displays the selection is complete.

Hewlett-Packard's 5X7 dot matrix alphanumeric displays are available in a variety of packages and font sizes, as well as four colors. Many of the newer and most popular products are also now available in AlGaAs Red. This wide diversity of packages, font heights, and colors mean solutions for your diverse applications.

In the intelligent display family look for the HDSP-250X large font eight digit and the HDSP-253X medium font eight digit displays. For high performance, consider the HCMS-29XX small and medium font four, eight, and sixteen digit displays. For your industrial applications the HDSP-665X medium font four character

glass/ceramic displays are also available. These intelligent displays give each customer a wide choice of new products to design into medical equipment, avionics, telecommunications, computer products, industrial or office equipment applications.

Also, part of HP's alphanumeric display line is the large 5X7 dot matrix alphanumeric display family which offers a variety of color selections as well as excellent viewing distances from 12-18 metres. Applications for these displays include industrial machinery and process controllers, weighing scales, computer tape drives, variable message signs, and transportation.

Hewlett-Packard also features a broad line of numeric seven segment displays. Included are low cost, standard red displays to high ambient light displays producing 7.5 mcd/segment. This broad product offering provides a solution to every display need.

They include several sizes in dual digit displays and the Micro Bright line of small package, bright displays.

HP's broad line of numeric seven segment displays is ideal for electronic instrumentation, industrial, weighing scales, point-of-sale terminals, game machines, and appliance applications. In this product line the Double Heterojunction AlGaAs red low current sunlight viewable display family is available in many package sizes. These AlGaAs numeric displays are ideal for battery operated and other low power applications.

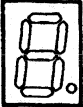

Where contrast is important, choose from the following HP seven segment display products: black surface seven segment displays, orange color seven segment displays and the smallest package on the market, the Ultra Mini 8 mm (0.31"). All devices are available as either common anode or common cathode.

## 8 mm (0.31 inch) Ultra Mini Seven Segment Displays

Device	P/N	Description	Color	Typical I <sub>v</sub>	Page No.
 <p>8.0 mm (0.31 in.) Dual-in-Line 0.43" H x 0.28" W x 0.20" D</p>	HDSP-U001 HDSP-U003	Common Anode Right Hand Decimal, Light Gray Surface, O Common Cathode Right Hand Decimal, Light Gray Surface, O	Red	1100 $\mu$ cd @ 20 mA	3-58
	HDSP-U011 HDSP-U013	Common Anode Right Hand Decimal, Black Surface, $\Delta$ Common Cathode Right Hand Decimal, Black Surface, $\Delta$			
	HDSP-U101 HDSP-U103	Common Anode Right Hand Decimal, Light Gray Surface, O Common Cathode Right Hand Decimal, Light Gray Surface, O	AlGaAs Red	600 $\mu$ cd @ 1 mA	
	HDSP-U111 HDSP-U113	Common Anode Right Hand Decimal, Black Surface, $\Delta$ Common Cathode Right Hand Decimal, Black Surface, $\Delta$			
	HDSP-U201 HDSP-U203	Common Anode Right Hand Decimal, Light Gray Surface, O Common Cathode Right Hand Decimal, Light Gray Surface, O	High Efficiency Red	980 $\mu$ cd @ 5 mA	
	HDSP-U211 HDSP-U213	Common Anode Right Hand Decimal, Black Surface, $\Delta$ Common Cathode Right Hand Decimal, Black Surface, $\Delta$			
	HDSP-U301 HDSP-U303	Common Anode Right Hand Decimal, Light Gray Surface, O Common Cathode Right Hand Decimal, Light Gray Surface, O	Yellow	480 $\mu$ cd @ 1 mA	
	HDSP-U311 HDSP-U313	Common Anode Right Hand Decimal, Black Surface, $\Delta$ Common Cathode Right Hand Decimal, Black Surface, $\Delta$			
	HDSP-U501 HDSP-U503	Common Anode Right Hand Decimal, Dark Gray Surface, $\Delta$ Common Cathode Right Hand Decimal, Dark Gray Surface, $\Delta$	Green	300 mcd @ 10 mA	
	HDSP-U511 HDSP-U513	Common Anode Right Hand Decimal, Black Surface, $\Delta$ Common Cathode Right Hand Decimal, Black Surface, $\Delta$			
	HDSP-U401 HDSP-U403	Common Anode Right Hand Decimal, Light Gray Surface, O Common Cathode Right Hand Decimal, Light Gray Surface, O	Orange	980 $\mu$ cd @ 5 mA	
	HDSP-U411 HDSP-U413	Common Anode Right Hand Decimal, Black Surface, $\Delta$ Common Cathode Right Hand Decimal, Black Surface, $\Delta$			

O = segment is not tinted  
 $\Delta$  = segment is tinted

## Black Surface Seven Segment Displays

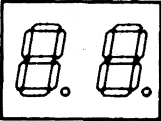
Device	P/N	Description	Color	Typical $I_f$	Page No.
 <p>7.62 mm (0.30 in.) Micro Bright Dual-in-Line 0.5" H x 0.3" W x 0.24" D</p>	HDSP-A011	Common Anode Right Hand Decimal, $\Delta$	Red	1100 $\mu\text{cd}$ @ 20 mA	3-18
	HDSP-A013	Common Cathode Right Hand Decimal, $\Delta$			
	HDSP-A211	Common Anode Right Hand Decimal, $\Delta$	High Efficiency Red	980 $\mu\text{cd}$ @ 5 mA	
	HDSP-A213	Common Cathode Right Hand Decimal, $\Delta$			
	HDSP-A111	Common Anode Right Hand Decimal, $\Delta$	AlGaAs Red	600 $\mu\text{cd}$ @ 1 mA	
	HDSP-A113	Common Cathode Right Hand Decimal, $\Delta$			
 <p>10.16 mm (0.40 in.) Dual-in-Line (Single Digit) 0.51" H x 0.39" W x 0.25" D</p>	HDSP-F011	Common Anode Right Hand Decimal, $\Delta$	Red	1200 $\mu\text{cd}$ @ 20 mA	
	HDSP-F013	Common Cathode Right Hand Decimal, $\Delta$			
	HDSP-F211	Common Anode Right Hand Decimal, $\Delta$	High Efficiency Red	1200 $\mu\text{cd}$ @ 5 mA	
	HDSP-F213	Common Cathode Right Hand Decimal, $\Delta$			
	HDSP-F111	Common Anode Right Hand Decimal, $\Delta$	AlGaAs Red	650 $\mu\text{cd}$ @ 1 mA	
	HDSP-F113	Common Cathode Right Hand Decimal, $\Delta$			
 <p>10.16 mm (0.40 in.) Dual-in-Line (Dual Digit) 0.51" H x 0.39" W x 0.25" D</p>	HDSP-G011	Two Digit Common Anode Right Hand Decimal, $\Delta$	Red	1200 $\mu\text{cd}$ @ 20 mA	
	HDSP-G013	Two Digit Common Cathode Right Hand Decimal, $\Delta$			
	HDSP-G211	Two Digit Common Anode Right Hand Decimal, $\Delta$	High Efficiency Red	1200 $\mu\text{cd}$ @ 5 mA	
	HDSP-G213	Two Digit Common Cathode Right Hand Decimal, $\Delta$			
	HDSP-G111	Two Digit Common Anode Right Hand Decimal, $\Delta$	AlGaAs Red	650 $\mu\text{cd}$ @ 1 mA	
	HDSP-G113	Two Digit Common Cathode Right Hand Decimal, $\Delta$			
	HDSP-G161	Two Digit Common Anode Right Hand Decimal, $\Delta$	AlGaAs Red	15.0 mcd @ 20 mA	
	HDSP-G163	Two Digit Common Cathode Right Hand Decimal, $\Delta$			
	HDSP-G511	Two Digit Common Anode Right Hand Decimal, $\Delta$	Green	3500 $\mu\text{cd}$ @ 10 mA	
	HDSP-G513	Two Digit Common Cathode Right Hand Decimal, $\Delta$			

O = segment is not tinted

$\Delta$  = segment is tinted

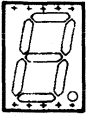
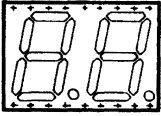
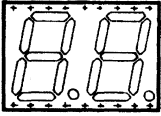
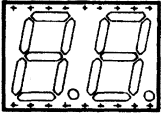

### Black Surface Seven Segment Displays (cont.)

Device	P/N	Description	Color	Typical $I_f$	Page No.
 <p>14.2 mm (0.56 in.) Dual-in-Line (Single Digit) 0.67" H x 0.49" W x 0.31" D</p>	HDSP-H011	Common Anode Right Hand Decimal, $\Delta$	Red	1300 $\mu$ cd @ 20 mA	3-18
	HDSP-H013	Common Cathode Right Hand Decimal, $\Delta$			
	HDSP-H211	Common Anode Right Hand Decimal, $\Delta$	High Efficiency Red	2800 $\mu$ cd @ 10 mA	
	HDSP-H213	Common Cathode Right Hand Decimal, $\Delta$			
	HDSP-H111	Common Anode Right Hand Decimal, $\Delta$	AlGaAs Red	700 $\mu$ cd @ 1 mA	
 <p>14.2 mm (0.56 in.) Dual-in-Line (Dual Digit) 0.67" H x 1.0" W x 0.31" D</p>	HDSP-K011	Two Digit Common Anode Right Hand Decimal, $\Delta$	Red	1300 $\mu$ cd @ 20 mA	
	HDSP-K013	Two Digit Common Cathode Right Hand Decimal, $\Delta$			
	HDSP-K211	Two Digit Common Anode Right Hand Decimal, $\Delta$	High Efficiency Red	2800 $\mu$ cd @ 10 mA	
	HDSP-K213	Two Digit Common Cathode Right Hand Decimal, $\Delta$			
 <p>14.2 mm (0.56 in.) Dual-in-Line (Dual Digit) 0.67" H x 1.0" W x 0.31" D</p>	HDSP-K111	Two Digit Common Anode Right Hand Decimal, $\Delta$	AlGaAs Red	700 $\mu$ cd 1 mA	
	HDSP-K113	Two Digit Common Cathode Right Hand Decimal, $\Delta$			
 <p>14.2 mm (0.56 in.) Dual-in-Line (Dual Digit) 0.67" H x 1.0" W x 0.31" D</p>	HDSP-K511	Two Digit Common Anode Right Hand Decimal, $\Delta$	Green	2500 $\mu$ cd @ 10 mA	
	HDSP-K513	Two Digit Common Cathode Right Hand Decimal, $\Delta$			

O = segment is not tinted

$\Delta$  = segment is tinted

LED DISPLAYS

## Low Current Seven Segment Displays

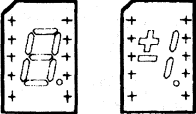
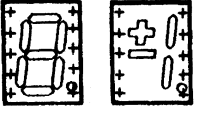
Device	P/N	Description	Color	Typical $I_f$	Page No.
 <p>7.62 mm (0.30 in.) Micro Bright Dual-in-Line 0.5" H x 0.3" W x 0.24" D</p>	HDSP-A101	Common Anode Right Hand Decimal, Light Gray Surface, O	AlGaAs Red	600 $\mu$ cd @ 1 mA	3-28
	HDSP-A103	Common Cathode Right Hand Decimal, Light Gray Surface, O			
	HDSP-A107	Common Anode $\pm 1$ . Overflow, Light Gray Surface, O			
	HDSP-A108	Common Cathode $\pm 1$ . Overflow, Light Gray Surface, O			
	HDSP-7511	Common Anode Right Hand Decimal, Light Gray Surface, O	High Efficiency Red	270 $\mu$ cd @ 2 mA	
	HDSP-7513	Common Cathode Right Hand Decimal, Light Gray Surface, O			
	HDSP-7517	Common Anode $\pm 1$ . Overflow, Light Gray Surface, O			
	HDSP-7518	Common Cathode $\pm 1$ . Overflow, Light Gray Surface, O			
	HDSP-A801	Common Anode Right Hand Decimal, Light Gray Surface, O	Yellow	420 $\mu$ cd @ 4 mA	
	HDSP-A803	Common Cathode Right Hand Decimal, Light Gray Surface, O			
	HDSP-A807	Common Anode $\pm 1$ . Overflow, Light Gray Surface, O			
	HDSP-A808	Common Cathode $\pm 1$ . Overflow, Light Gray Surface, O			
	HDSP-A901	Common Anode Right Hand Decimal, Dark Gray Surface, $\Delta$	Green	475 $\mu$ cd @ 4 mA	
	HDSP-A903	Common Cathode Right Hand Decimal, Dark Gray Surface, $\Delta$			
	HDSP-A907	Common Anode $\pm 1$ . Overflow, Dark Gray Surface, $\Delta$			
	HDSP-A908	Common Cathode $\pm 1$ . Overflow, Dark Gray Surface, $\Delta$			
 <p>10.16 mm (0.40 in.) Dual-in-Line (Single Digit) 0.51" H x 0.39" W x 0.25" D</p>	HDSP-F101	Common Anode Right Hand Decimal, Light Gray Surface, O	AlGaAs Red	650 $\mu$ cd @ 1 mA	
	HDSP-F103	Common Cathode Right Hand Decimal, Light Gray Surface, O			
	HDSP-F107	Common Anode $\pm 1$ . Overflow, Light Gray Surface, O			
	HDSP-F108	Common Cathode $\pm 1$ . Overflow, Light Gray Surface, O			
	HDSP-G101	Two Digit Common Anode Right Hand Decimal, Light Gray Surface, O			
	HDSP-G103	Two Digit Common Cathode Right Hand Decimal, Light Gray Surface, O			

O = segment is not tinted

$\Delta$  = segment is tinted

### Low Current Seven Segment Displays (cont.)

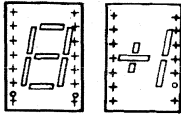
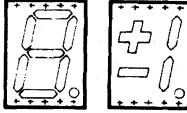
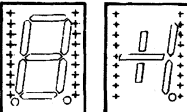
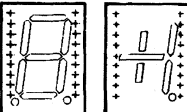
Device	P/N	Description	Color	Typical $I_v$	Page No.
 <p>10.92 mm (0.43 in.) Dual-in-Line 0.75" H x 0.5" W x 0.25" D</p>	HDSP-E100	Common Anode Left Hand Decimal, Light Gray Surface, O	AlGaAs Red	650 $\mu$ cd @ 1 mA	3-28
	HDSP-E101	Common Anode Right Hand Decimal, Light Gray Surface, O			
	HDSP-E103	Common Cathode Right Hand Decimal, Light Gray Surface, O			
	HDSP-E108	Universal $\pm 1$ . Overflow, Light Gray Surface, O			
	HDSP-3350	Common Anode Right Hand Decimal, Red Surface, $\Delta$	High Efficiency Red	300 $\mu$ cd @ 2 mA	
	HDSP-3351	Common Cathode Right Hand Decimal, Red Surface, $\Delta$			
HDSP-3353	Common Anode $\pm 1$ . Overflow, Red Surface, $\Delta$				
HDSP-3356	Common Cathode $\pm 1$ . Overflow, Red Surface, $\Delta$				
 <p>14.2 mm (0.56 in.) Dual-in-Line (Single Digit) 0.67" H x 0.49" W x 0.31" D</p>	HDSP-H101	Common Anode Right Hand Decimal, Light Gray Surface, O	AlGaAs Red	700 $\mu$ cd @ 1 mA	
	HDSP-H103	Common Cathode Right Hand Decimal, Light Gray Surface, O			
	HDSP-H107	Common Anode $\pm 1$ . Overflow, Light Gray Surface, O			
	HDSP-H108	Common Cathode $\pm 1$ . Overflow, Light Gray Surface, O			
	HDSP-K121	Two Digit Common Anode Right Hand Decimal, Light Gray Surface, O			
	HDSP-K123	Two Digit Common Cathode Right Hand Decimal, Light Gray Surface, O			
 <p>20 mm (0.8 in.) Dual-in-Line 1.09" H x 0.78" W x 0.33" D</p>	HDSP-5551	Common Anode Right Hand Decimal, Light Gray Surface, O	High Efficiency Red	370 $\mu$ cd @ 2 mA	
	HDSP-5553	Common Cathode Right Hand Decimal, Light Gray Surface, O			
	HDSP-5557	Common Anode $\pm 1$ . Overflow, Light Gray Surface, O			
	HDSP-5558	Common Cathode $\pm 1$ . Overflow, Light Gray Surface, O			
	HDSP-K701	Two Digit Common Anode Right Hand Decimal, Light Gray Surface, O			
	HDSP-K703	Two Digit Common Cathode Right Hand Decimal, Light Gray Surface, O			
 <p>20 mm (0.8 in.) Dual-in-Line 1.09" H x 0.78" W x 0.33" D</p>	HDSP-N100	Common Anode Left Hand Decimal, Light Gray Surface, O	AlGaAs Red	590 $\mu$ cd @ 1 mA	
	HDSP-N101	Common Anode Right Hand Decimal, Light Gray Surface, O			
	HDSP-N103	Common Cathode Right Hand Decimal, Light Gray Surface, O			
	HDSP-N105	Common Cathode Left Hand Decimal, Light Gray Surface, O			
	HDSP-N106	Universal $\pm 1$ . Overflow, Light Gray Surface, O			

O = segment is not tinted  
 $\Delta$  = segment is tinted

LED DISPLAYS

## Seven Segment Displays

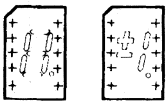
Device	P/N	Description	Color	Typical $I_v$	Page No.
 <p>7.62 mm (0.3 in.) Micro Bright Dual-in-Line 0.5" H x 0.3" W x 0.24" D</p>	HDSP-7301	Common Anode Right Hand Decimal, Light Gray Surface, O	Red	1100 $\mu$ cd @ 20 mA	3-66
	HDSP-7302	Common Anode Right Hand Decimal, Colon, Light Gray Surface, O			
	HDSP-7303	Common Cathode Right Hand Decimal, Light Gray Surface, O			
	HDSP-7304	Common Cathode Right Hand Decimal, Colon, Light Gray Surface, O			
	HDSP-7307	Common Anode $\pm 1$ . Overflow, Light Gray Surface, O			
	HDSP-7308	Common Cathode $\pm 1$ . Overflow, Light Gray Surface, O			
	HDSP-A151	Common Anode Right Hand Decimal, Light Gray Surface, O	AlGaAs Red	14 mcd @ 20 mA	
	HDSP-A153	Common Cathode Right Hand Decimal, Light Gray Surface, O			
	HDSP-A157	Common Anode $\pm 1$ . Overflow, Light Gray Surface, O			
	HDSP-A158	Common Cathode $\pm 1$ . Overflow, Light Gray Surface, O			
	HDSP-7501	Common Anode Right Hand Decimal, Light Gray Surface, O	High Efficiency Red	980 $\mu$ cd @ 5 mA	
	HDSP-7502	Common Anode Right Hand Decimal, Colon, Light Gray Surface, O			
	HDSP-7503	Common Cathode Right Hand Decimal, Light Gray Surface, O			
	HDSP-7504	Common Cathode Right Hand Decimal, Colon, Light Gray Surface, O			
	HDSP-7507	Common Anode $\pm 1$ . Overflow, Light Gray Surface, O			
	HDSP-7508	Common Cathode $\pm 1$ . Overflow, Light Gray Surface, O			
	HDSP-7401	Common Anode Right Hand Decimal, Light Gray Surface, O	Yellow	480 $\mu$ cd @ 5 mA	
	HDSP-7402	Common Anode Right Hand Decimal, Colon, Light Gray Surface, O			
	HDSP-7403	Common Cathode Right Hand Decimal, Light Gray Surface, O			
	HDSP-7404	Common Cathode Right Hand Decimal, Colon, Light Gray Surface, O			
	HDSP-7407	Common Anode $\pm 1$ . Overflow, Light Gray Surface, O			
	HDSP-7408	Common Cathode $\pm 1$ . Overflow, Light Gray Surface, O			
	HDSP-7801	Common Anode Right Hand Decimal, Dark Gray Surface, $\Delta$	Green	3000 $\mu$ cd @ 10 mA	
	HDSP-7802	Common Anode Right Hand Decimal, Colon, Dark Gray Surface, $\Delta$			
HDSP-7803	Common Cathode Right Hand Decimal, Dark Gray Surface, $\Delta$				
HDSP-7804	Common Cathode Right Hand Decimal, Colon, Dark Gray Surface, $\Delta$				
HDSP-7807	Common Anode $\pm 1$ . Overflow, Dark Gray Surface, $\Delta$				
HDSP-7808	Common Cathode $\pm 1$ . Overflow, Dark Gray Surface, $\Delta$				

O = segment is not tinted

$\Delta$  = segment is tinted

## Seven Segment Displays (cont.)

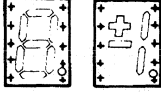
Device	P/N	Description	Color	Typical $I_v$	Page No.
 <p>10.16 mm (0.4 in.) Dual-In-Line (Single Digit) 0.51" H x 0.39" W x 0.25" D</p>	HDSP-F001 HDSP-F003	Common Anode Right Hand Decimal, Light Gray Surface, O Common Cathode Right Hand Decimal, Light Gray Surface, O	Red	1200 $\mu$ cd @ 20 mA	3-74
	HDSP-F007 HDSP-F008 HDSP-G001	Common Anode $\pm 1$ . Overflow, Light Gray Surface, O Common Cathode $\pm 1$ . Overflow, Light Gray Surface, O Two Digit Common Anode Right Hand Decimal, Light Gray Surface, O			
	HDSP-G003	Two Digit Common Cathode Right Hand Decimal, Light Gray Surface, O			
	HDSP-F151 HDSP-F153	Common Anode Right Hand Decimal, Light Gray Surface, O Common Cathode Right Hand Decimal, Light Gray Surface, O	AlGaAs Red	15.0 mcd @ 20 mA	
	HDSP-F157 HDSP-F158 HDSP-G151	Common Anode $\pm 1$ . Overflow, Light Gray Surface, O Common Cathode $\pm 1$ . Overflow, Light Gray Surface, O Two Digit Common Anode Right Hand Decimal, Light Gray Surface, O			
	HDSP-G153	Two Digit Common Cathode Right Hand Decimal, Light Gray Surface, O			
	HDSP-F201 HDSP-F203	Common Anode Right Hand Decimal, Light Gray Surface, O Common Cathode Right Hand Decimal, Light Gray Surface, O	High Efficiency Red	1200 $\mu$ cd @ 5 mA	
	HDSP-F207 HDSP-F208 HDSP-G201	Common Anode $\pm 1$ . Overflow, Light Gray Surface, O Common Cathode $\pm 1$ . Overflow, Light Gray Surface, O Two Digit Common Anode Right Hand Decimal, Light Gray Surface, O			
	HDSP-G203	Two Digit Common Cathode Right Hand Decimal, Light Gray Surface, O			
	HDSP-F401 HDSP-F403	Common Anode Right Hand Decimal, Light Gray Surface, O Common Cathode Right Hand Decimal, Light Gray Surface, O	Orange	1200 $\mu$ cd @ 5 mA	
HDSP-F407 HDSP-F408 HDSP-G401	Common Anode $\pm 1$ . Overflow, Light Gray Surface, O Common Cathode $\pm 1$ . Overflow, Light Gray Surface, O Two Digit Common Anode Right Hand Decimal, Light Gray Surface, O				
HDSP-G403	Two Digit Common Cathode Right Hand Decimal, Light Gray Surface, O				
HDSP-F301 HDSP-F303	Common Anode Right Hand Decimal, Light Gray Surface, O Common Cathode Right Hand Decimal, Light Gray Surface, O	Yellow	800 $\mu$ cd @ 5 mA		
HDSP-F307 HDSP-F308 HDSP-G301	Common Anode $\pm 1$ . Overflow, Light Gray Surface, O Common Cathode $\pm 1$ . Overflow, Light Gray Surface, O Two Digit Common Anode Right Hand Decimal, Light Gray Surface, O				
HDSP-G303	Two Digit Common Cathode Right Hand Decimal, Light Gray Surface, O				
HDSP-F501 HDSP-F503	Common Anode Right Hand Decimal, Dark Gray Surface, $\Delta$ Common Cathode Right Hand Decimal, Dark Gray Surface, $\Delta$	Green	3500 $\mu$ cd @ 10 mA		
HDSP-F507 HDSP-F508 HDSP-G501	Common Anode $\pm 1$ . Overflow, Dark Gray Surface, $\Delta$ Common Cathode $\pm 1$ . Overflow, Dark Gray Surface, $\Delta$ Two Digit Common Anode Right Hand Decimal, Dark Gray Surface, $\Delta$				
HDSP-G503	Two Digit Common Cathode Right Hand Decimal, Dark Gray Surface, $\Delta$				

O = segment is not tinted  
 $\Delta$  = segment is tinted

LED  
DISPLAYS

### Seven Segment Displays (cont.)

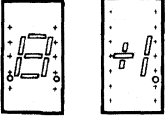
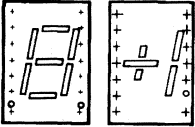
Device	P/N	Description	Color	Typical I <sub>v</sub>	Page No.
 <p>7.62 mm (0.3 in.) Dual-in-Line 0.75" H x 0.4" W x 0.18" D</p>	5082-7730	Common Anode Left Hand Decimal, Black Surface, Δ	Red	770 μcd @ 20 mA	3-50
	5082-7731	Common Anode Right Hand Decimal, Black Surface, Δ			
	5082-7740	Common Cathode Right Hand Decimal, Black Surface, Δ			
	5082-7736	Universal ±1. Overflow, Right Hand Decimal, Black Surface, Δ			
	5082-7610	Common Anode Left Hand Decimal, Red Surface, Δ	High Efficiency Red	800 μcd @ 5 mA	
	5082-7611	Common Anode Right Hand Decimal, Red Surface, Δ			
	5082-7613	Common Cathode Right Hand Decimal, Red Surface, Δ			
	5082-7616	Universal ±1. Overflow, Right Hand Decimal, Red Surface, Δ			
	5082-7620	Common Anode Left Hand Decimal, Yellow Surface, Δ	Yellow	620 μcd @ 5 mA	
	5082-7621	Common Anode Right Hand Decimal, Yellow Surface, Δ			
	5082-7623	Common Cathode Right Hand Decimal, Yellow Surface, Δ			
	5082-7626	Universal ±1. Overflow, Right Hand Decimal, Yellow Surface, Δ			
HDSP-3600	Common Anode Left Hand Decimal, Dark Gray Surface, Δ	Green	2700 μcd @ 10 mA		
HDSP-3601	Common Anode Right Hand Decimal, Dark Gray Surface, Δ				
HDSP-3603	Common Cathode Right Hand Decimal, Dark Gray Surface, Δ				
HDSP-3606	Universal ±1. Overflow, Right Hand Decimal, Dark Gray Surface, Δ				
 <p>10.92 mm (0.43 in.) Dual-in-Line 0.75" H x 0.5" W x 0.25" D</p>	5082-7750	Common Anode Left Hand Decimal, Red Surface, Δ	Red	1100 μcd @ 20 mA	
	5082-7751	Common Anode Right Hand Decimal, Red Surface, Δ			
	5082-7760	Common Cathode Right Hand Decimal, Red Surface, Δ			
	5082-7756	Universal ±1. Overflow, Right Hand Decimal, Red Surface, Δ			
	HDSP-E150	Common Anode Left Hand Decimal, Light Gray Surface, O	AlGaAs Red	15.0 mcd @ 20 mA	
	HDSP-E151	Common Anode Right Hand Decimal, Light Gray Surface, O			
	HDSP-E153	Common Cathode Right Hand Decimal, Light Gray Surface, O			
	HDSP-E156	Universal ±1. Overflow, Right Hand Decimal, Light Gray Surface, O			
	5082-7650	Common Anode Left Hand Decimal, Red Surface, Δ	High Efficiency Red	1115 μcd @ 5 mA	
	5082-7651	Common Anode Right Hand Decimal, Red Surface, Δ			
	5082-7653	Common Cathode Right Hand Decimal, Red Surface, Δ			
	5082-7656	Universal ±1. Overflow, Right Hand Decimal, Red Surface, Δ			
5082-7660	Common Anode Left Hand Decimal, Yellow Surface, Δ	Yellow	835 μcd @ 5 mA		
5082-7661	Common Anode Right Hand Decimal, Yellow Surface, Δ				
5082-7663	Common Cathode Right Hand Decimal, Yellow Surface, Δ				
5082-7666	Universal ±1. Overflow, Right Hand Decimal, Yellow Surface, Δ				
HDSP-4600	Common Anode Left Hand Decimal, Dark Gray Surface, Δ	Green	4000 μcd @ 10 mA		
HDSP-4601	Common Anode Right Hand Decimal, Dark Gray Surface, Δ				
HDSP-4603	Common Cathode Right Hand Decimal, Dark Gray Surface, Δ				
HDSP-4606	Universal ±1. Overflow, Right Hand Decimal, Dark Gray Surface, Δ				

O = segment is not tinted

Δ = segment is tinted

## Seven Segment Displays (cont.)

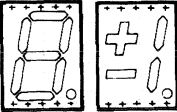
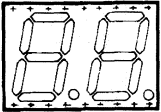
Device	P/N	Description	Color	Typical $I_f$	Page No.			
 <p>14.2 mm (0.56 in.) Dual-in-Line (Single Digit) 0.67" H x 0.49" W x 0.31" D</p>  <p>14.2 mm (0.56 in.) Dual-in-Line (Two Digit) 0.67" H x 1.0" W x 0.31" D</p>	HDSP-5301	Common Anode Right Hand Decimal, Light Gray Surface, O	Red	1300 $\mu$ cd @ 20 mA	3-84			
	HDSP-5303	Common Cathode Right Hand Decimal, Light Gray Surface, O						
	HDSP-5307	Common Anode $\pm 1$ . Overflow, Light Gray Surface, O						
	HDSP-5308	Common Cathode $\pm 1$ . Overflow, Light Gray Surface, O						
	HDSP-5321	Two Digit Common Anode Right Hand Decimal, Light Gray Surface, O						
	HDSP-5323	Two Digit Common Cathode Right Hand Decimal, Light Gray Surface, O						
	HDSP-H151	Common Anode Right Hand Decimal, Light Gray Surface, O				AlGaAs Red	16.0 mcd @ 20 mA	3-28
	HDSP-H153	Common Cathode Right Hand Decimal, Light Gray Surface, O						
	HDSP-H157	Common Anode $\pm 1$ . Overflow, Light Gray Surface, O						
	HDSP-H158	Common Cathode $\pm 1$ . Overflow, Light Gray Surface, O						
HDSP-K121	Two Digit Common Anode Right Hand Decimal, Light Gray Surface, O							
HDSP-K123	Two Digit Common Cathode Right Hand Decimal, Light Gray Surface, O							
HDSP-5501	Common Anode Right Hand Decimal, Light Gray Surface, O	High Efficiency Red	2800 $\mu$ cd @ 10 mA	3-84				
HDSP-5503	Common Cathode Right Hand Decimal, Light Gray Surface, O							
HDSP-5507	Common Anode $\pm 1$ . Overflow, Light Gray Surface, O							
HDSP-5508	Common Cathode $\pm 1$ . Overflow, Light Gray Surface, O							
HDSP-5521	Two Digit Common Anode Right Hand Decimal, Light Gray Surface, O							
HDSP-5523	Two Digit Common Cathode Right Hand Decimal, Light Gray Surface, O							
HDSP-5701	Common Anode Right Hand Decimal, Light Gray Surface, O	Yellow	1800 $\mu$ cd @ 10 mA					
HDSP-5703	Common Cathode Right Hand Decimal, Light Gray Surface, O							
HDSP-5707	Common Anode $\pm 1$ . Overflow, Light Gray Surface, O							
HDSP-5708	Common Cathode $\pm 1$ . Overflow, Light Gray Surface, O							
HDSP-5721	Two Digit Common Anode Right Hand Decimal, Light Gray Surface, O							
HDSP-5723	Two Digit Common Cathode Right Hand Decimal, Light Gray Surface, O							
HDSP-5601	Common Anode Right Hand Decimal, Dark Gray Surface, $\Delta$	Green	2500 $\mu$ cd @ 10 mA					
HDSP-5603	Common Cathode Right Hand Decimal, Dark Gray Surface, $\Delta$							
HDSP-5607	Common Anode $\pm 1$ . Overflow, Dark Gray Surface, $\Delta$							
HDSP-5608	Common Cathode $\pm 1$ . Overflow, Dark Gray Surface, $\Delta$							
HDSP-5621	Two Digit Common Anode Right Hand Decimal, Dark Gray Surface, $\Delta$							
HDSP-5623	Two Digit Common Cathode Right Hand Decimal, Dark Gray Surface, $\Delta$							

O = segment is not tinted

$\Delta$  = segment is tinted

LED  
DISPLAYS

### Seven Segment Displays (cont.)

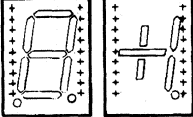
Device	P/N	Description	Color	Typical $I_v$	Page No.
 <p>20 mm (0.8 in.) Dual-in-Line 1.09" H x 0.78" W x 0.33" D</p>	HDSP-3400	Common Anode Left Hand Decimal, Light Gray Surface, O	Red	1200 $\mu$ cd @ 20 mA	3-92
	HDSP-3401	Common Anode Right Hand Decimal, Light Gray Surface, O			
	HDSP-3403	Common Cathode Right Hand Decimal, Light Gray Surface, O			
	HDSP-3405	Common Cathode Left Hand Decimal, Light Gray Surface, O			
	HDSP-3406	Universal $\pm 1$ . Overflow, Right Hand Decimal, Light Gray Surface, O			
	HDSP-N150	Common Anode Left Hand Decimal, Light Gray Surface, O	AlGaAs Red	14.0 mcd @ 20 mA	
	HDSP-N151	Common Anode Right Hand Decimal, Light Gray Surface, O			
	HDSP-N153	Common Cathode Right Hand Decimal, Light Gray Surface, O			
	HDSP-N155	Common Cathode Left Hand Decimal, Light Gray Surface, O			
	HDSP-N156	Universal $\pm 1$ . Overflow, Right Hand Decimal, Light Gray Surface, O			
	HDSP-3900	Common Anode Left Hand Decimal, Light Gray Surface, O	High Efficiency Red	7000 $\mu$ cd @ 100 mA peak 1/5 Duty Factor	
	HDSP-3901	Common Anode Right Hand Decimal, Light Gray Surface, O			
	HDSP-3903	Common Cathode Right Hand Decimal, Light Gray Surface, O			
	HDSP-3905	Common Cathode Left Hand Decimal, Light Gray Surface, O			
	HDSP-3906	Universal $\pm 1$ . Overflow, Right Hand Decimal, Light Gray Surface, O			
	HDSP-4200	Common Anode Left Hand Decimal, Light Gray Surface, O	Yellow	7000 $\mu$ cd @ 100 mA peak 1/5 Duty Factor	
	HDSP-4201	Common Anode Right Hand Decimal, Light Gray Surface, O			
	HDSP-4203	Common Cathode Right Hand Decimal, Light Gray Surface, O			
	HDSP-4205	Common Cathode Left Hand Decimal, Light Gray Surface, O			
	HDSP-4206	Universal $\pm 1$ . Overflow, Right Hand Decimal, Light Gray Surface, O			
HDSP-8600	Common Anode Left Hand Decimal, Dark Gray Surface, $\Delta$	Green	1500 $\mu$ cd @ 10 mA		
HDSP-8601	Common Anode Right Hand Decimal, Dark Gray Surface, $\Delta$				
HDSP-8603	Common Cathode Right Hand Decimal, Dark Gray Surface, $\Delta$				
HDSP-8605	Common Cathode Left Hand Decimal, Dark Gray Surface, $\Delta$				
HDSP-8606	Universal $\pm 1$ . Overflow, Right Hand Decimal, Dark Gray Surface, $\Delta$				

O = segment is not tinted

$\Delta$  = segment is tinted

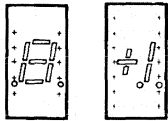
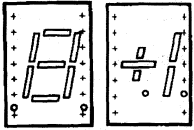
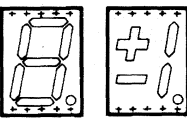

## High Ambient Light, Seven Segment Displays

Device	P/N	Description	Typical $I_v$ @ 100 mA Peak 1/5 Duty Factor	Page No.
 <p>7.62 mm (0.3 in.) Dual-in-Line 0.75" H x 0.4" W x 0.18" D</p>	HDSP-3530	High Efficiency Red, Common Anode, LHDP, Light Gray Surface, O	7100 $\mu$ cd/seg	3-42
	HDSP-3531	High Efficiency Red, Common Anode, RHDP, Light Gray Surface, O		
	HDSP-3533	High Efficiency Red, Common Cathode, RHDP, Light Gray Surface, O		
	HDSP-3536	High Efficiency Red, Universal Polarity Overflow Indicator, RHDP, Light Gray Surface, O		
	HDSP-4030	Yellow, Common Anode, LHDP, Light Gray Surface, O		
	HDSP-4031	Yellow, Common Anode, RHDP, Light Gray Surface, O		
 <p>10.92 mm (0.43 in.) Dual-in-Line 0.75" H x 0.5" W x 0.25" D</p>	HDSP-3730	High Efficiency Red, Common Anode, LHDP, Light Gray Surface, O	10900 $\mu$ cd/seg	
	HDSP-3731	High Efficiency Red, Common Anode, RHDP, Light Gray Surface, O		
	HDSP-3733	High Efficiency Red, Common Cathode, RHDP, Light Gray Surface, O		
	HDSP-3736	High Efficiency Red, Universal Polarity Overflow Indicator, RHDP, Light Gray Surface, O		
	HDSP-4130	Yellow, Common Anode, LHDP, Light Gray Surface, O		
	HDSP-4131	Yellow, Common Anode, RHDP, Light Gray Surface, O		
 <p>14.2 mm (0.56 in.) Dual-in-Line 0.67" H x 0.49" W x 0.31" D</p>	HDSP-4133	Yellow, Common Cathode, RHDP, Light Gray Surface, O	6000 $\mu$ cd/seg	
	HDSP-4136	Yellow, Universal Polarity Overflow Indicator, RHDP, Light Gray Surface, O		
	HDSP-5531	High Efficiency Red, Common Anode, RHDP, Light Gray Surface, O		
	HDSP-5533	High Efficiency Red, Common Cathode, RHDP, Light Gray Surface, O		
	HDSP-5537	High Efficiency Red $\pm 1$ . Common Anode, Light Gray Surface, O		
	HDSP-5538	High Efficiency Red $\pm 1$ . Common Cathode, Light Gray Surface, O		
<td>HDSP-5731</td> <td>Yellow, Common Anode, RHDP, Light Gray Surface, O</td> <td rowspan="4">5500 <math>\mu</math>cd/seg</td> <td rowspan="4"></td>	HDSP-5731	Yellow, Common Anode, RHDP, Light Gray Surface, O	5500 $\mu$ cd/seg	
	HDSP-5733	Yellow, Common Cathode, RHDP, Light Gray Surface, O		
	HDSP-5737	Yellow, $\pm 1$ . Common Anode, Light Gray Surface, O		
	HDSP-5738	Yellow, $\pm 1$ . Common Cathode, Light Gray Surface, O		

O = segment is not tinted

$\Delta$  = segment is tinted



## Solid State Display Intensity and Color Selections

Option	Description	Page No.
Option S01 Option S02 Option S20	Intensity and Color Selected Displays	*





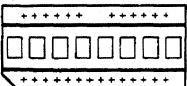
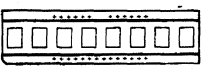
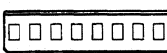
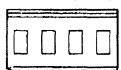

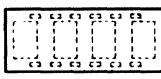
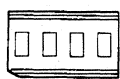
\*Contact your local Hewlett-Packard sales representative for information regarding this product.

LED  
DISPLAYS

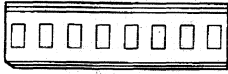
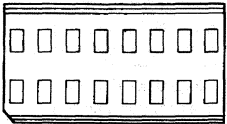
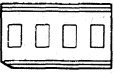
## Alphanumeric LED Displays

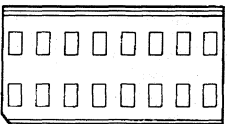
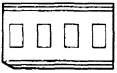
Device	P/N	Description	Color	Application	Page No.
	HDSP-2110 HDSP-2111 HDSP-2112 HDSP-2113 HDSP-2107	5.0 mm (0.2 in.) 5 x 7 Eight Character Intelligent Display Operating Temperature Range: -45°C to +85°C ASCII Character Set	Orange Yellow High Efficiency Red Green AlGaAs Red	<ul style="list-style-type: none"> <li>• Medical</li> <li>• Telecommunications</li> <li>• Analytical Equipment</li> <li>• Computer Products</li> <li>• Office Equipment</li> <li>• Industrial Equipment</li> </ul>	3-140
	HDSP-2500 HDSP-2501 HDSP-2502 HDSP-2503	7 mm (0.27 in.) ASCII 5 x 7 Eight Character Intelligent Display Operating Temperature Range: -45°C to +85°C	Orange Yellow High Efficiency Red Green	<ul style="list-style-type: none"> <li>• Computer Peripherals</li> <li>• Industrial Instrumentation</li> <li>• Medical Equipment</li> <li>• Portable Data Entry Devices</li> <li>• Cellular Phones</li> <li>• Telecommunications</li> <li>• Test Equipment</li> </ul>	
	HDSP-2530 HDSP-2531 HDSP-2532 HDSP-2533 HDSP-2534	5.0 mm (0.2 in.) Eight Character Intelligent Display Operating Temperature Range: -40°C to +85°C	Orange Yellow High Efficiency Red Green AlGaAs Red	<ul style="list-style-type: none"> <li>• Avionics</li> <li>• Computer Peripherals</li> <li>• Industrial Instrumentation</li> <li>• Medical Equipment</li> <li>• Portable Data Entry Devices</li> <li>• Telecommunications</li> <li>• Test Equipment</li> </ul>	3-125
	HDLA-2416 HDLG-2416 HDLO-2416 HDLR-2416 HDLS-2416 HDLU-2416 HDLY-2416	5.0 mm (0.2 in.) 5 x 7 Four Character Intelligent Display Operating Temperature Range: -40°C to +85°C	Orange Green High Efficiency Red Red AlGaAs Red (SV) AlGaAs Red (LP) Yellow	<ul style="list-style-type: none"> <li>• Portable Data Entry Devices</li> <li>• Industrial Instrumentation</li> <li>• Computer Peripherals</li> <li>• Telecommunications</li> </ul>	3-164
	HPDL-1414 HPDL-2416	2.85 mm (0.112 in.) 4.1 mm (0.16 in.) 16-Segment Four Character Monolithic Intelligent Display Operating Temperature Range: -40°C to +85°C	Red Red	<ul style="list-style-type: none"> <li>• Portable Data Entry Devices</li> <li>• Medical Equipment</li> <li>• Industrial Instrumentation</li> <li>• Computer Peripherals</li> <li>• Telecommunications</li> </ul>	3-175
	HCMS-2000 HCMS-2001 HCMS-2002 HCMS-2003 HCMS-2004	3.8 mm (0.15 in.) 5 x 7 Four Character Display 12 pin Ceramic DIP 7.6 mm (0.30 in.) Operating Temperature Range: -40°C to +85°C	Red Yellow High Efficiency Red Green Orange	<ul style="list-style-type: none"> <li>• Computer Terminals</li> <li>• Business Machines</li> <li>• Portable, Hand-held or Mobile Data Entry, Read-out, or Communications</li> </ul>	3-156
	HCMS-2300 HCMS-2301 HCMS-2302 HCMS-2303 HCMS-2304	5.0 mm (0.20 in.) 5 x 7 Four Character Display 12 pin Ceramic DIP 6.35 mm (0.250 in.) Operating Temperature Range: -40°C to +85°C	Red Yellow High Efficiency Red Green Orange	<ul style="list-style-type: none"> <li>• Avionics</li> <li>• Ground Support, Cockpit, Shipboard Systems</li> <li>• Medical Equipment</li> <li>• Industrial and Process Control</li> <li>• Computer Peripherals and Terminals</li> </ul>	
	HCMS-2700 HCMS-2701 HCMS-2702 HCMS-2703 HCMS-2704	1 Row of 4 Characters 3.8 mm (0.15 in.) 5 x 7 Dot Matrix, Full ASCII Character Set	Standard Red Yellow High Efficiency Red Green Orange	<ul style="list-style-type: none"> <li>• Telecommunications</li> <li>• Instrumentation</li> <li>• Medical Instrumentation</li> <li>• Business Machines</li> </ul>	3-100

## Alphanumeric LED Displays (Cont.)

Device	P/N	Description	Color	Application	Page No.		
	HCMS-2710 HCMS-2711 HCMS-2712 HCMS-2713 HCMS-2714	1 Row of 8 Characters	Standard Red Yellow HER Green Orange		3-100		
	HCMS-2720 HCMS-2721 HCMS-2722 HCMS-2723 HCMS-2724	2 Rows of 8 Characters	Standard Red Yellow HER Green Orange				
	HCMS-2901 HCMS-2902 HCMS-2903 HCMS-2904 HCMS-2905	1 Row of 4 Characters 3.8 mm (0.15 in.) 5 x 7 Dot Matrix Fully Integrated Serial-in Display	Yellow HER Green Orange AlGaAs			<ul style="list-style-type: none"> <li>• Telecommunications</li> <li>• Portable Data Entry Devices</li> <li>• Computer Peripherals</li> <li>• Medical Equipment</li> <li>• Test Equipment</li> <li>• Business Machines</li> <li>• Avionics</li> <li>• Industrial Controls</li> </ul>	3-109
	HCMS-2911 HCMS-2912 HCMS-2913 HCMS-2914 HCMS-2915	1 Row of 8 Characters 3.8 mm (0.15 in.)	Yellow HER Green Orange AlGaAs				
	HCMS-2921 HCMS-2922 HCMS-2923 HCMS-2924 HCMS-2925	2 Rows of 8 Characters 3.8 mm (0.15 in.)	Yellow HER Green Orange AlGaAs				
	HCMS-2961 HCMS-2962 HCMS-2963 HCMS-2964 HCMS-2965	1 Row of 4 Characters 5.0 mm (0.20 in.)	Yellow HER Green Orange AlGaAs				
	HCMS-2971 HCMS-2972 HCMS-2973 HCMS-2974 HCMS-2975	1 Row of 8 Characters 5.0 mm (0.20 in.)	Yellow HER Green Orange AlGaAs				
 	HDSP-2490 HDSP-2491 HDSP-2492 HDSP-2493	6.9 mm (0.27 in.) 5 x 7 Four Character Alphanumeric 28 Pin Ceramic 15.24 mm (0.6 in.) DIP with Untinted Glass Lens  Operating Temperature Range: -20°C to +85°C	Red  Yellow  High Efficiency Red  High Performance Green	<ul style="list-style-type: none"> <li>• High Brightness Ambient Systems</li> <li>• Industrial and Process Control</li> <li>• Computer Peripherals</li> <li>• Ground Support Systems</li> </ul> For further information see Application Note 1016.	*		

\*Contact your local Hewlett-Packard sales representative for information regarding this product.

LED  
DISPLAYS

### Large Alphanumeric 5 X 7 Displays

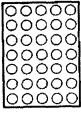
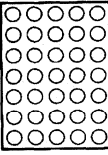
Device	P/N	Description	Color	Package	Typical I <sub>v</sub>	Page No.
	HDSP-4701	Common Row Anode	Red	17.3 mm (0.68 in.) Dual-in-Line 0.70 in. H x 0.50 in. W x 0.26 in. D	770 μcd/dot 100 mA peak 1/5 Duty Factor 1650 μcd/dot 10 mA peak 1/5 Duty Factor 2800 μcd/dot 50 mA peak 1/5 Duty Factor 4000 μcd/dot 50 mA peak 1/5 Duty Factor	3-200
	HDSP-4703	Common Row Cathode	Red			
	HDSP-L101	Common Row Anode	AlGaAs Red			
	HDSP-L103	Common Row Cathode	AlGaAs Red			
	HDSP-L201	Common Row Anode	High Efficiency Red			
	HDSP-5401	Common Row Anode	Green			
HDSP-5403	Common Row Cathode	Green				
	HDSP-4401	Common Row Anode	Red	26.5 mm (1.04 in.) Dual-in-Line 1.10 in. H x 0.79 in. W x 0.25 in. D	800 μcd/dot 100 mA peak 1/5 Duty Factor 1850 μcd/dot 10 mA peak 1/5 Duty Factor 3500 μcd/dot 50 mA peak 1/5 Duty Factor 4500 μcd/dot 50 mA peak 1/5 Duty Factor	
	HDSP-4403	Common Row Cathode	Red			
	HDSP-M101	Common Row Anode	AlGaAs Red			
	HDSP-M103	Common Row Cathode	AlGaAs Red			
	HDSP-4501	Common Row Anode	High Efficiency Red			
	HDSP-4503	Common Row Cathode	High Efficiency Red			
	HDSP-5101	Common Row Anode	Green			
	HDSP-5103	Common Row Cathode	Green			

### Hexadecimal and Dot Matrix Displays

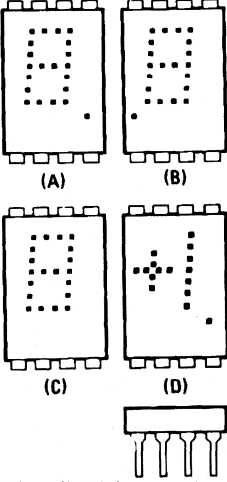
Device	P/N	Description	Package	Application	Page No.
 <p>7.4 mm (0.29 in.) 4 x 7 Single Digit</p>	5082-7300 (A)	Numeric RHDP Built-in Decoder/Driver/Memory	8 Pin Epoxy 15.2 mm (0.6 in.) DIP	General Purpose Market • Test Equipment • Business Machines • Computer Peripherals • Avionics	3-187
	5082-7302 (B)	Numeric LHDP Built-in Decoder/Driver/Memory			
	5082-7340 (C)	Hexadecimal Built-in Decoder/Driver/Memory			
	5082-7304 (D)	Over Range ±1			

## Hexadecimal and Dot Matrix Displays (Cont.)

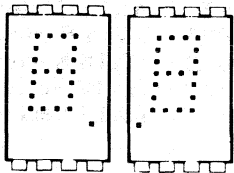
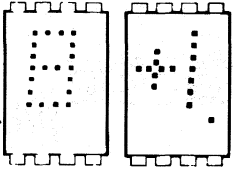
Device	P/N	Description	Package	Application	Page No.
	HDSP-0760 (A)	Numeric RHDP Built-in Decoder/Driver/Memory	High Efficiency Red Low Power	<ul style="list-style-type: none"> <li>• Military Equipment</li> <li>• Ground Support Equipment</li> <li>• Avionics</li> <li>• High Reliability Applications</li> </ul>	3-193
	HDSP-0761 (B)	Numeric LHDP Built-in Decoder/Driver/Memory			
	HDSP-0762 (C)	Hexadecimal Built-in Decoder/Driver/Memory			
	HDSP-0763 (D)	Over Range $\pm 1$			
	HDSP-0770 (A)	Numeric RHDP Built-in Decoder/Driver/Memory	High Efficiency Red High Brightness	<ul style="list-style-type: none"> <li>• High Brightness Ambient Systems</li> <li>• Cockpit, Shipboard Equipment</li> <li>• High Reliability Applications</li> </ul>	
	HDSP-0771 (B)	Numeric LHDP Built-in Decoder/Driver/Memory			
	HDSP-0772 (C)	Hexadecimal Built-in Decoder/Driver/Memory			
<p>7.4 mm (0.29 in.) 4 x 7 Single Digit Package: 8 Pin Glass Ceramic 15.2 mm (0.6 in.) DIP</p>	HDSP-0860 (A)	Numeric RHDP Built-in Decoder/Driver/Memory	Yellow	<ul style="list-style-type: none"> <li>• Business Machines</li> <li>• Fire Control Systems</li> <li>• Military Equipment</li> <li>• High Reliability Applications</li> </ul>	
	HDSP-0861 (B)	Numeric LHDP Built-in Decoder/Driver/Memory			
	HDSP-0862 (C)	Hexadecimal Built-in Decoder/Driver/Memory			
	HDSP-0863 (D)	Over Range $\pm 1$			
	HDSP-0960 (A)	Numeric RHDP Built-in Decoder/Driver/Memory	High Performance Green	<ul style="list-style-type: none"> <li>• Business Machines</li> <li>• Fire Control Systems</li> <li>• Military Equipment</li> <li>• High Reliability Applications</li> </ul>	
	HDSP-0961 (B)	Numeric LHDP Built-in Decoder/Driver/Memory			
	HDSP-0962 (C)	Hexadecimal Built-in Decoder/Driver/Memory			
	HDSP-0963 (D)	Over Range $\pm 1$			

Glass/Ceramic Selection Guide is located on 3-209.

LED  
DISPLAYS

# Black Surface Seven Segment Displays

## Technical Data

**HDSP-AX11/-AX13 Series**  
**HDSP-FX11/-FX13 Series**  
**HDSP-GX11/-GX13 Series**  
**HDSP-HX11/-HX13 Series**  
**HDSP-KX11/-KX13 Series**

### Features

- **Black Surface and Color Tinted Epoxy**
- **Industry Standard Size**
- **Industry Standard Pinout**
- **Choice of Character Size**  
7.6 mm (0.30 in.), 10 mm (0.40 in.), 14.2 mm (0.56 in.)
- **Choice of Colors**  
Red, AlGaAs Red, High Efficiency Red (HER), Green
- **Excellent Appearance**  
Evenly Lighted Segments  
± 50° Viewing Angle

- **Design Flexibility**  
Common Anode or Common Cathode  
Single and Two Digit
- **Categorized for Luminous Intensity**  
Categorized for Color: Green  
Use of Like Categories Yields a Uniform Display
- **Excellent for Long Digit String Multiplexing**

### Description

These devices use industry standard size package and pinout. Available with black surface finish. All devices are available as

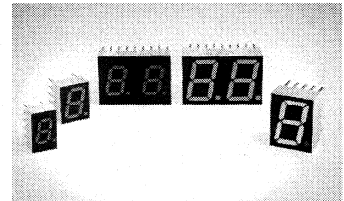

either common anode or common cathode.

Typical applications include appliances, channel indicators of TV, CATV converters, game machines, and point of sale terminals.

### Devices

Red HDSP-	AlGaAs Red HDSP-	HER HDSP-	Green HDSP-	Description	Package Drawing
A011	A111	A211	A511	7.6 mm Common Anode Right Hand Decimal	A
A013	A113	A213	A513	7.6 mm Common Cathode Right Hand Decimal	B
F011	F111	F211	F511	10 mm Common Anode Right Hand Decimal	C
F013	F113	F213	F513	10 mm Common Cathode Right Hand Decimal	D
G011	G111	G211	G511	10 mm Two Digit Common Anode Right Hand Decimal	E
G013	G113	G213	G513	10 mm Two Digit Common Cathode Right Hand Decimal	F
H011	H111	H211	H511	14.2 mm Common Anode Right Hand Decimal	G
H013	H113	H213	H513	14.2 mm Common Cathode Right Hand Decimal	H
K011	K111	K211	K511	14.2 mm Two Digit Common Anode Right Hand Decimal	I
K013	K113	K213	K513	14.2 mm Two Digit Common Cathode Right Hand Decimal	J

## Package Dimensions (7.6 mm Series)

## Internal Circuit Diagram

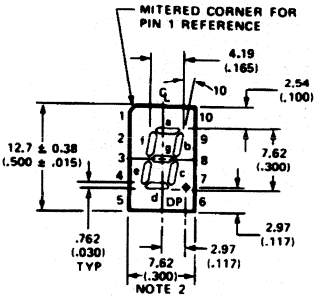

A, B

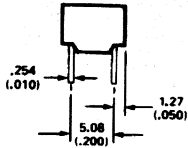

A, B

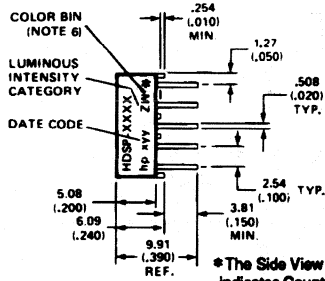

\*The Side View of package indicates Country of Origin.

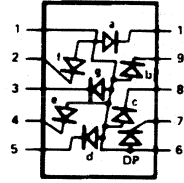

A

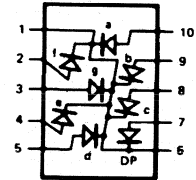

B

PIN	FUNCTION	
	A	B
1	ANODE <sup>(a)</sup>	CATHODE <sup>(a)</sup>
2	CATHODE f	ANODE f
3	CATHODE g	ANODE g
4	CATHODE e	ANODE e
5	CATHODE d	ANODE d
6	ANODE <sup>(a)</sup>	CATHODE <sup>(a)</sup>
7	CATHODE DP	ANODE DP
8	CATHODE c	ANODE c
9	CATHODE b	ANODE b
10	CATHODE a	ANODE a

### NOTES:

1. ALL DIMENSIONS IN MILLIMETERS (INCHES).
2. MAXIMUM.
3. ALL UNTOLERANCED DIMENSIONS ARE FOR REFERENCE ONLY.
4. REDUNDANT ANODES.
5. REDUNDANT CATHODES.
6. FOR HDSP-A511/-A513 ONLY.

SEVEN SEGMENT  
NUMERIC DISPLAYS

## Package Dimensions (10 mm Series: Single)

## Internal Circuit Diagram

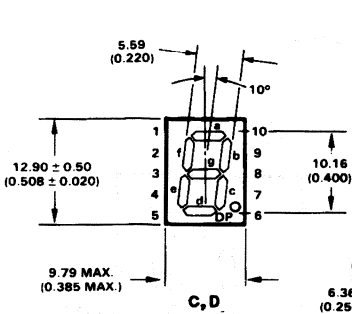

C, D

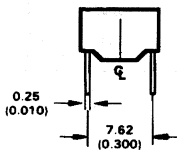

C, D

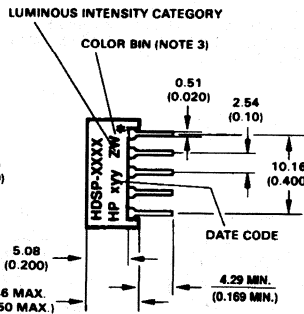

C, D

\*The Side View of package indicates Country of Origin.

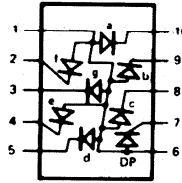

C

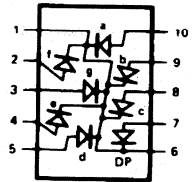

D

PIN	FUNCTION	
	C	D
1	ANODE <sup>(a)</sup>	CATHODE <sup>(a)</sup>
2	CATHODE f	ANODE f
3	CATHODE g	ANODE g
4	CATHODE e	ANODE e
5	CATHODE d	ANODE d
6	ANODE <sup>(a)</sup>	CATHODE <sup>(a)</sup>
7	CATHODE DP	ANODE DP
8	CATHODE c	ANODE c
9	CATHODE b	ANODE b
10	CATHODE a	ANODE a

### NOTES:

1. ALL DIMENSIONS IN MILLIMETERS (INCHES).
2. ALL UNTOLERANCED DIMENSIONS ARE FOR REFERENCE ONLY.
3. FOR HDSP-F511/-F513 ONLY.
4. REDUNDANT ANODES.
5. REDUNDANT CATHODES.

# Package Dimensions (10 mm Series: Two Digit)

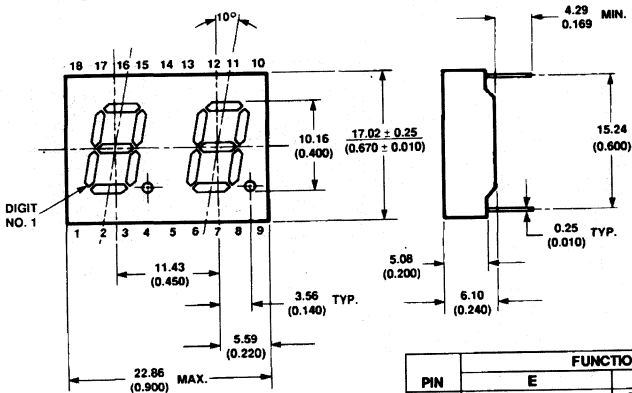

E, F

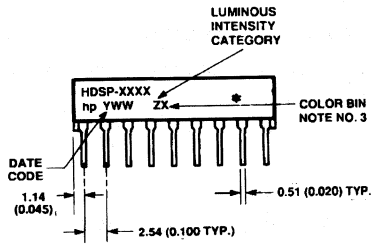

E, F

\* The Side View of package indicates Country of Origin.

# Internal Circuit Diagram

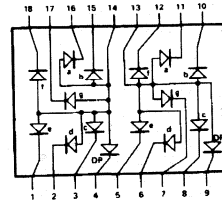

E

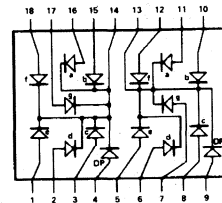

F

PIN	FUNCTION	
	E	F
1	E CATHODE NO. 1	E ANODE NO. 1
2	D CATHODE NO. 1	D ANODE NO. 1
3	C CATHODE NO. 1	C ANODE NO. 1
4	DP CATHODE NO. 1	DP ANODE NO. 1
5	E CATHODE NO. 2	E ANODE NO. 2
6	D CATHODE NO. 2	D ANODE NO. 2
7	G CATHODE NO. 2	G ANODE NO. 2
8	C CATHODE NO. 2	C ANODE NO. 2
9	CP CATHODE NO. 2	DP ANODE NO. 2
10	B CATHODE NO. 2	B ANODE NO. 2
11	A CATHODE NO. 2	A ANODE NO. 2
12	F CATHODE NO. 2	F ANODE NO. 2
13	DIGIT NO. 2 ANODE	DIGIT NO. 2 CATHODE
14	DIGIT NO. 1 ANODE	DIGIT NO. 1 CATHODE
15	B CATHODE NO. 1	B ANODE NO. 1
16	A CATHODE NO. 2	A ANODE NO. 1
17	G CATHODE NO. 1	G ANODE NO. 1
18	F CATHODE NO. 1	F ANODE NO. 1

### NOTES:

1. DIMENSIONS ARE IN MILLIMETERS (INCHES).
2. ALL UNTOLERANCED DIMENSIONS ARE FOR REFERENCE ONLY.
3. FOR HDSP-G5111-G513 ONLY.

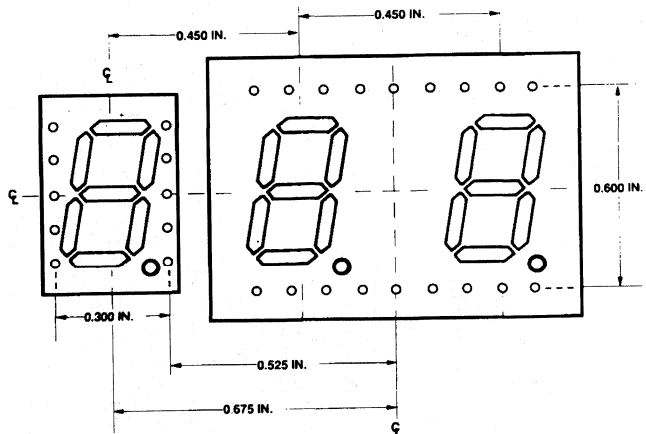

HOLE PATTERN FOR PCB LAYOUT TO ACHIEVE UNIFORM 0.450 DIGIT TO DIGIT PITCH. FOR HDSP-FXXX TO HDSP-GXXX.



### Package Dimensions (14.2 mm Series: Single)

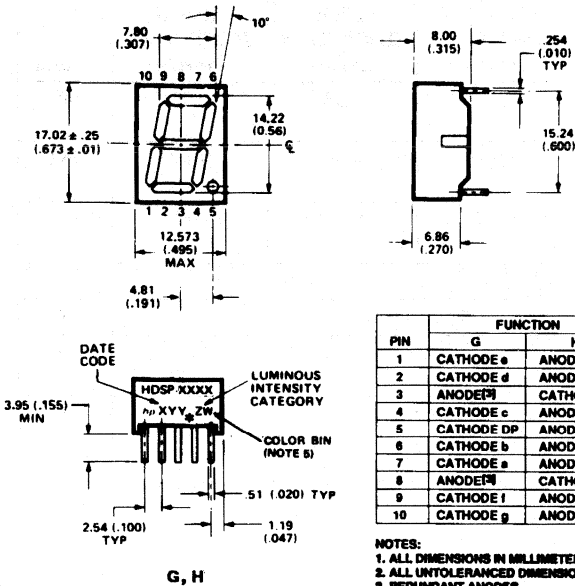

\*The End View of package indicates Country of Origin.

PIN	FUNCTION	
	G	H
1	CATHODE a	ANODE a
2	CATHODE d	ANODE d
3	ANODE <sup>(1)</sup>	CATHODE <sup>(1)</sup>
4	CATHODE c	ANODE c
5	CATHODE DP	ANODE DP
6	CATHODE b	ANODE b
7	CATHODE e	ANODE e
8	ANODE <sup>(1)</sup>	CATHODE <sup>(1)</sup>
9	CATHODE f	ANODE f
10	CATHODE g	ANODE g

- NOTES:  
 1. ALL DIMENSIONS IN MILLIMETERS (INCHES).  
 2. ALL UNTOLERANCED DIMENSIONS ARE FOR REFERENCE ONLY.  
 3. REDUNDANT ANODES.  
 4. REDUNDANT CATHODES.  
 5. FOR HDSP-HS11-HS13 ONLY.

### Internal Circuit Diagram

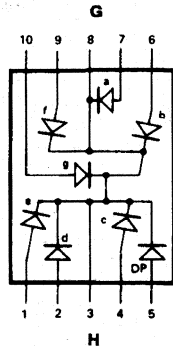
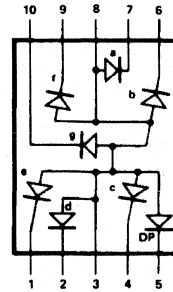

SEVEN SEGMENT  
NUMERIC DISPLAYS

### Package Dimensions (14.2 mm Series: Two Digit)

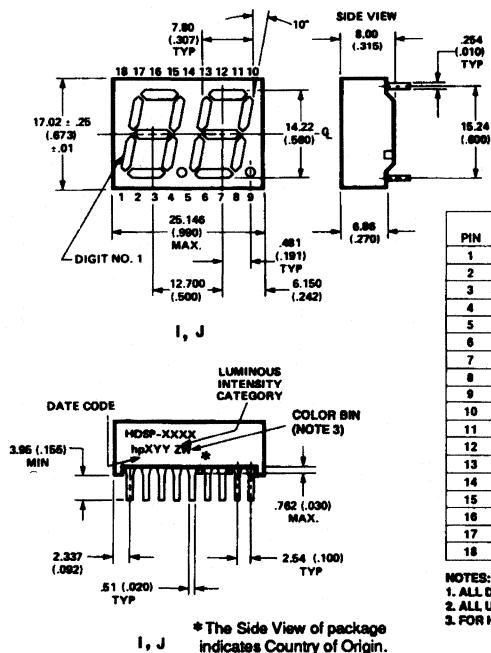

\*The Side View of package indicates Country of Origin.

PIN	FUNCTION	
	I	J
1	E CATHODE NO. 1	E ANODE NO. 1
2	D CATHODE NO. 1	D ANODE NO. 1
3	C CATHODE NO. 1	C ANODE NO. 1
4	DP CATHODE NO. 1	DP ANODE NO. 1
5	E CATHODE NO. 2	E ANODE NO. 2
6	D CATHODE NO. 2	D ANODE NO. 2
7	G CATHODE NO. 2	G ANODE NO. 2
8	C CATHODE NO. 2	C ANODE NO. 2
9	DP CATHODE NO. 2	DP ANODE NO. 2
10	B CATHODE NO. 2	B ANODE NO. 2
11	A CATHODE NO. 2	A ANODE NO. 2
12	F CATHODE NO. 2	F ANODE NO. 2
13	DIGIT NO. 2 ANODE	DIGIT NO. 2 CATHODE
14	DIGIT NO. 1 ANODE	DIGIT NO. 2 CATHODE
15	B CATHODE NO. 2	B ANODE NO. 1
16	A CATHODE NO. 1	A ANODE NO. 1
17	G CATHODE NO. 1	G ANODE NO. 1
18	F CATHODE NO. 1	F ANODE NO. 1

- NOTES:  
 1. ALL DIMENSIONS IN MILLIMETERS (INCHES).  
 2. ALL UNTOLERANCED DIMENSIONS ARE FOR REFERENCE ONLY.  
 3. FOR HDSP-HS11-HS13 ONLY.

### Internal Circuit Diagram

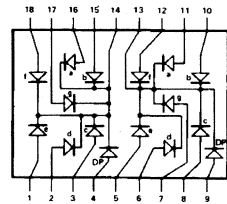
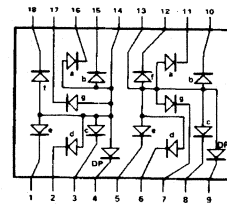

## Absolute Maximum Ratings

Description	Red HDSP-X01X Series	AlGaAs Red HDSP-X11X Series	HER HDSP-X21X Series	Green HDSP-X51X Series	Units
Average Power per Segment or DP	82	37	105	105	mW
Peak Forward Current per Segment or DP	150 <sup>[1]</sup>	45	90 <sup>[3]</sup>	90 <sup>[5]</sup>	mA
DC Forward Current per Segment or DP	25 <sup>[2]</sup>	15 <sup>[7]</sup>	30 <sup>[4]</sup>	30 <sup>[6]</sup>	mA
Operating Temperature Range	-40 to +100	-20 to +100	-40 to +100		°C
Storage Temperature Range	-55 to +100				°C
Reverse Voltage per Segment or DP	3.0				V
Lead Solder Temperature for 3 Seconds (1.60 mm [0.063 in.] below seating plane)	260				°C

### Notes:

1. See Figure 1 to establish pulsed conditions.
2. Derate above 80°C at 0.63 mA/°C (see Figure 2).
3. See Figure 10 to establish pulsed conditions.
4. Derate above 53°C at 0.45 mA/°C (see Figure 12).
5. See Figure 11 to establish pulsed conditions.
6. Derate above 39°C at 0.37 mA/°C (see Figure 12).
7. Derate above 91°C at 0.53 mA/°C (see Figure 6).

## Electrical/Optical Characteristics at $T_A = 25^\circ\text{C}$

### Red

Device Series HDSP-	Parameter	Symbol	Min.	Typ.	Max.	Units	Test Conditions	
A01X	Luminous Intensity/Segment <sup>[1,2]</sup> (Digit Average)	$I_V$	600	1100		$\mu\text{cd}$	$I_F = 20\text{ mA}$	
F01X, G01X				500			$I_F = 10\text{ mA}$	
H01X, K01X				650	1200			$I_F = 20\text{ mA}$
				600	1300			$I_F = 20\text{ mA}$
			1400			$I_F = 100\text{ mA Peak}$ 1/5 Duty Factor		
All Devices	Forward Voltage/Segment or DP	$V_F$		1.6	2.0	V	$I_F = 20\text{ mA}$	
	Peak Wavelength	$\lambda_{\text{PEAK}}$		655		nm		
	Dominant Wavelength <sup>[3]</sup>	$\lambda_d$		640		nm		
	Reverse Voltage/Segment or DP <sup>[4]</sup>	$V_R$	3.0	12		V	$I_R = 100\ \mu\text{A}$	
	Temperature Coefficient of $V_F$ /Segment or DP	$\Delta V_F/^\circ\text{C}$		-2		$\text{mV}/^\circ\text{C}$		
A01X	Thermal Resistance LED Junction-to-Pin	$R\theta_{\text{J-PIN}}$		200		$^\circ\text{C}/\text{W}/\text{Seg.}$		
F01X, G01X				320				
H01X, K01X				345				

SEVEN SEGMENT  
NUMERIC DISPLAYS

### AlGaAs Red

Device Series HDSP-	Parameter	Symbol	Min.	Typ.	Max.	Units	Test Conditions
A11X	Luminous Intensity/Segment <sup>[1,2]</sup> (Digit Average)	$I_V$	315	600		$\mu\text{cd}$	$I_F = 1\text{ mA}$
F11X, G11X				3600			$I_F = 5\text{ mA}$
				330	650		
H11X, K11X				3900			$I_F = 5\text{ mA}$
				400	700		
				4200			$I_F = 5\text{ mA}$
All Devices	Forward Voltage/Segment or DP	$V_F$		1.6	2.0	V	$I_F = 1\text{ mA}$
				1.7			$I_F = 5\text{ mA}$
				1.8	22		$I_F = 20\text{ mA Peak}$
	Peak Wavelength	$\lambda_{\text{PEAK}}$		645		nm	
	Dominant Wavelength <sup>[3]</sup>	$\lambda_d$		637		nm	
	Reverse Voltage/Segment or DP <sup>[4]</sup>	$V_R$	3.0	15		V	$I_R = 100\ \mu\text{A}$
	Temperature Coefficient of $V_F$ /Segment or DP	$\Delta V_F/^\circ\text{C}$		-2		$\text{mV}/^\circ\text{C}$	
A11X	Thermal Resistance LED Junction-to-Pin	$R\theta_{\text{J-PIN}}$		255		$^\circ\text{C}/\text{W}/\text{Seg.}$	
F11X, G11X				320			
H11X, K12X				400			

### High Efficiency Red

Device Series HDSP-	Parameter	Symbol	Min.	Typ.	Max.	Units	Test Conditions
A21X	Luminous Intensity/Segment <sup>1,2]</sup> (Digit Average)	I <sub>V</sub>	360	980		μcd	I <sub>F</sub> = 5 mA
				5390			I <sub>F</sub> = 20 mA
F21X, G21X			420	1200			I <sub>F</sub> = 5 mA
H21X, K21X			900	2800			I <sub>F</sub> = 10 mA
				3700			I <sub>F</sub> = 60 mA Peak: 1/6 Duty Factor
All Devices	Forward Voltage/Segment or DP	V <sub>F</sub>		2.0	2.5	V	I <sub>F</sub> = 20 mA
	Peak Wavelength	λ <sub>PEAK</sub>		635		nm	
	Dominant Wavelength <sup>[3]</sup>	λ <sub>d</sub>		626		nm	
	Reverse Voltage/Segment or DP <sup>[4]</sup>	V <sub>R</sub>	3.0	30		V	I <sub>R</sub> = 100 μA
	Temperature Coefficient of V <sub>F</sub> /Segment or DP	ΔV <sub>F</sub> /°C		-2		mV/°C	
A21X	Thermal Resistance LED Junction-to-Pin	Rθ <sub>J-PIN</sub>		200		°C/W/ Seg.	
F21X, G21X				320			
H21X, K21X				345			

### High Performance Green

Device Series HDSP-	Parameter	Symbol	Min.	Typ.	Max.	Units	Test Conditions
A51X	Luminous Intensity/Segment <sup>1,2]</sup> (Digit Average)	I <sub>V</sub>	860	3000		μcd	I <sub>F</sub> = 10 mA
				6800			I <sub>F</sub> = 20 mA
F51X, G51X			1030	3500			I <sub>F</sub> = 10 mA
H51X, K51X			900	2500			I <sub>F</sub> = 10 mA
				3100			I <sub>F</sub> = 60 mA Peak: 1/6 Duty Factor
All Devices	Forward Voltage/Segment or DP	V <sub>F</sub>		2.1	2.5	V	I <sub>F</sub> = 10 mA
	Peak Wavelength	λ <sub>PEAK</sub>		566		nm	
	Dominant Wavelength <sup>[3,5]</sup>	λ <sub>d</sub>		571	577	nm	
	Reverse Voltage/Segment or DP <sup>[4]</sup>	V <sub>R</sub>	3.0	50		V	I <sub>R</sub> = 100 μA
	Temperature Coefficient of V <sub>F</sub> /Segment or DP	ΔV <sub>F</sub> /°C		-2		mV/°C	
A51X	Thermal Resistance LED Junction-to-Pin	Rθ <sub>J-PIN</sub>		200		°C/W/ Seg.	
F51X, G51X				320			
H51X, G51X				345			

#### Notes:

- Case temperature of device immediately prior to the intensity measurement is 25°C.
- The digits are categorized for luminous intensity. The intensity category is designated by a letter on the side of the package.
- The dominant wavelength, λ<sub>d</sub>, is derived from the CIE chromaticity diagram and is that single wavelength which defines the color of the device.
- Typical specification for reference only. Do not exceed absolute maximum ratings.
- Green (HDSP-A51X/F51X/G51X/H512X/K51X) series displays are categorized for dominant wavelength. The category is designated by a number adjacent to the luminous intensity category letter.

# Red

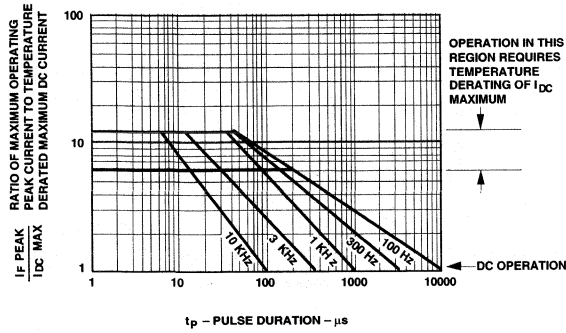

Figure 1. Maximum Tolerable Peak Current vs. Pulse Duration - Red.

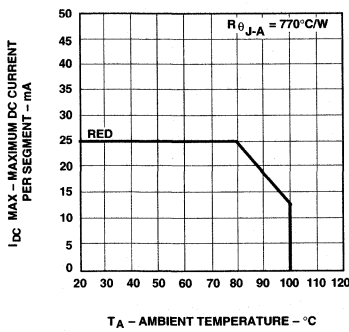

Figure 2. Maximum Allowable DC Current vs. Ambient Temperature.

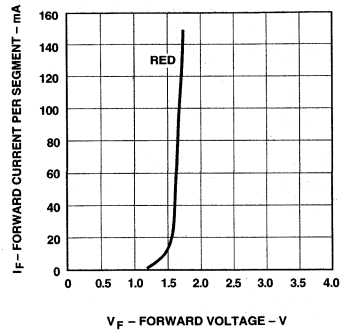

Figure 3. Forward Current vs. Forward Voltage.

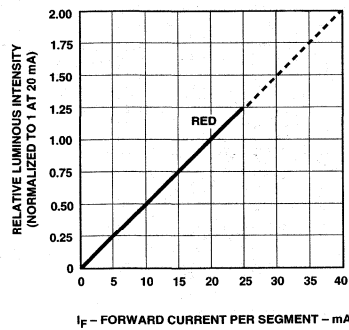

Figure 4. Relative Luminous Intensity vs. DC Forward Current.

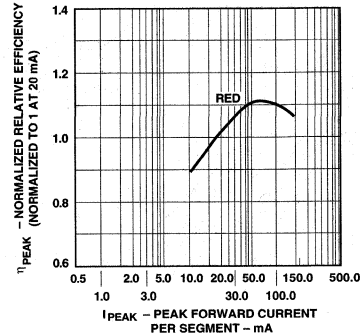

Figure 5. Relative Efficiency (Luminous Intensity per Unit Current) vs. Peak Current.

SEVEN SEGMENT  
NUMERIC DISPLAYS

## AlGaAs Red

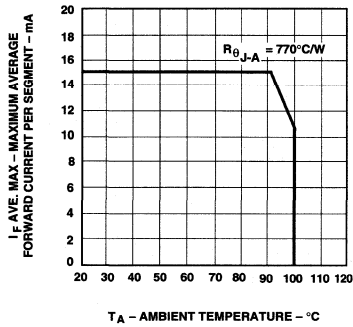

Figure 6. Maximum Allowable Average or DC Current vs. Ambient Temperature.

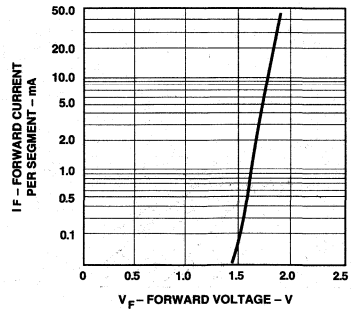

Figure 7. Forward Current vs. Forward Voltage.

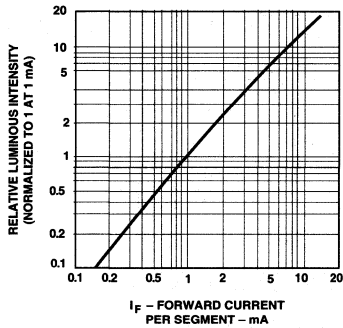

Figure 8. Relative Luminous Intensity vs. DC Forward Current.

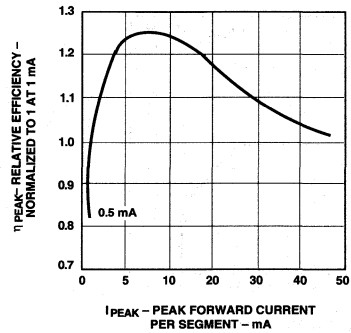

Figure 9. Relative Efficiency (Luminous Intensity per Unit Current) vs. Peak Current.

## HER, Green

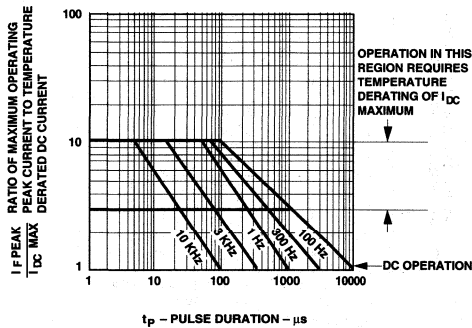

Figure 10. Maximum Tolerable Peak Current vs. Pulse Duration - HER.

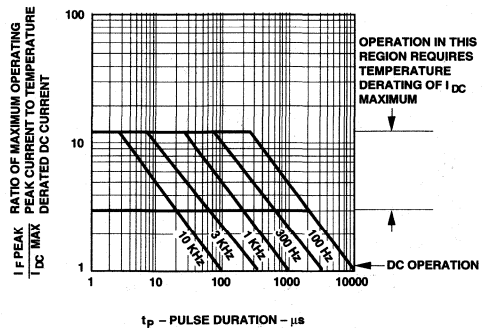

Figure 11. Maximum Tolerable Peak Current vs. Pulse Duration - Green.

## HER, Green, (cont.)

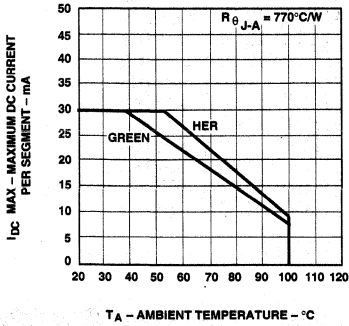

Figure 12. Maximum Allowable DC Current vs. Ambient Temperature.

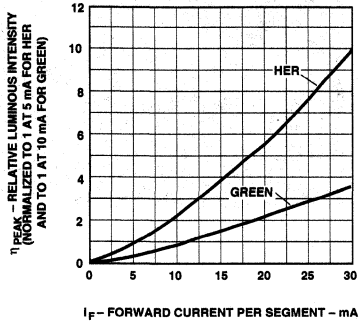

Figure 14. Relative Luminous Intensity vs. DC Forward Current.

## Contrast Enhancement

For information on contrast enhancement, please see Application Note 1015.

## Soldering/Cleaning

For information on soldering LEDs please refer to Application Note 1029.

## Electrical/Optical

For more information on electrical/optical characteristics, please see Application Note 1005.

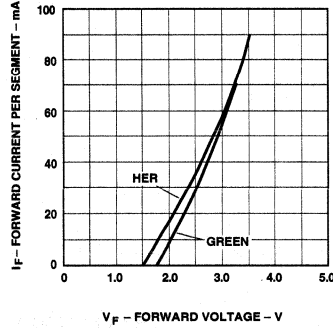

Figure 13. Forward Current vs. Forward Voltage Characteristics.

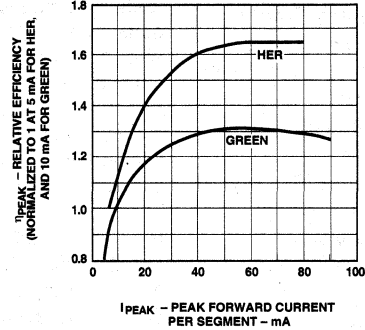

Figure 15. Relative Efficiency (Luminous Intensity per Unit Current) vs. Peak Current.

SEVEN SEGMENT  
NUMERIC DISPLAYS

---

# Low Current Seven Segment Displays

## Technical Data

HDSP-335X Series  
HDSP-555X Series  
HDSP-751X Series  
HDSP-A10X Series  
HDSP-A80X Series  
HDSP-A90X Series  
HDSP-E10X Series  
HDSP-F10X Series  
HDSP-G10X Series  
HDSP-H10X Series  
HDSP-K12X, K70X Series  
HDSP-N10X Series

---

### Features

- **Low Power Consumption**
- **Industry Standard Size**
- **Industry Standard Pinout**
- **Choice of Character Size**  
7.6 mm (0.30 in), 10 mm (0.40 in), 10.9 mm (0.43 in), 14.2 mm (0.56 in), 20 mm (0.80 in)
- **Choice of Colors**  
AlGaAs Red, High Efficiency Red (HER), Yellow, Green
- **Excellent Appearance**  
Evenly Lighted Segments  
± 50° Viewing Angle
- **Design Flexibility**  
Common Anode or Common Cathode  
Single and Dual Digit  
Left and Right Hand Decimal Points  
± 1. Overflow Character
- **Categorized for Luminous Intensity**  
Yellow and Green Categorized for Color  
Use of Like Categories Yields a Uniform Display
- **Excellent for Long Digit String Multiplexing**

### Description

These low current seven segment displays are designed for applications requiring low power consumption. They are tested and selected for their excellent low current characteristics to ensure that the segments are matched at low currents. Drive currents as low as 1 mA per segment are available.

Pin for pin equivalent displays are also available in a standard current or high light ambient design. The standard current displays are available in all colors and are ideal for most applications. The high light ambient displays are ideal for sunlight ambients or long string lengths. For additional information see the 7.6 mm Micro Bright Seven Segment Displays, 10 mm Seven Segment Displays, 7.6 mm/10.9 mm Seven Segment Displays, 14.2 mm Seven Segment Displays, 20 mm Seven Segment Displays, or High Light Ambient Seven Segment Displays data sheets.

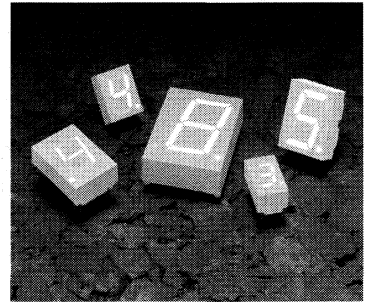



## Devices

AlGaAs HDSP-	HER HDSP-	Yellow HDSP-	Green HDSP-	Description	Package Drawing
A101	7511	A801	A901	7.6 mm Common Anode Right Hand Decimal	A
A103	7513	A803	A903	7.6 mm Common Cathode Right Hand Decimal	B
A107	7517	A807	A907	7.6 mm Common Anode ± 1. Overflow	C
A108	7518	A808	A908	7.6 mm Common Cathode ± 1. Overflow	D
F101				10 mm Common Anode Right Hand Decimal	E
F103				10 mm Common Cathode Right Hand Decimal	F
F107				10 mm Common Anode ± 1. Overflow	G
F108				10 mm Common Cathode ± 1. Overflow	H
G101				10 mm Two Digit Common Anode Right Hand Decimal	X
G103				10 mm Two Digit Common Cathode Right Hand Decimal	Y
E100	3350			10.9 mm Common Anode Left Hand Decimal	I
E101	3351			10.9 mm Common Anode Right Hand Decimal	J
E103	3353			10.9 mm Common Cathode Right Hand Decimal	K
E106	3356			10.9 mm Universal ± 1. Overflow <sup>[1]</sup>	L
H101	5551			14.2 mm Common Anode Right Hand Decimal	M
H103	5553			14.2 mm Common Cathode Right Hand Decimal	N
H107	5557			14.2 mm Common Anode ± 1. Overflow	O
H108	5558			14.2 mm Common Cathode ± 1. Overflow	P
K121	K701			14.2 mm Two Digit Common Anode Right Hand Decimal	R
K123	K703			14.2 mm Two Digit Common Cathode Right Hand Decimal	S
N100				20 mm Common Anode Left Hand Decimal	Q
N101				20 mm Common Anode Right Hand Decimal	T
N103				20 mm Common Cathode Right Hand Decimal	U
N105				20 mm Common Cathode Left Hand Decimal	V
N106				20 mm Universal ± 1. Overflow <sup>[1]</sup>	W

### Note:

1. Universal pinout brings the anode and cathode of each segment's LED out to separate pins. See internal diagrams L or W.

## Package Dimensions

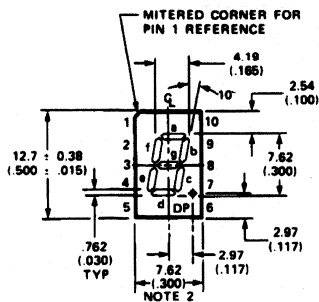

A, B

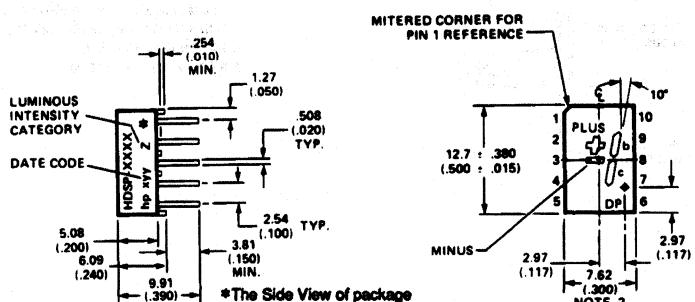

C, D

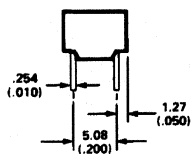

A, B, C, D

PIN	FUNCTION			
	A	B	C	D
1	ANODE <sup>[4]</sup>	CATHODE <sup>[5]</sup>	ANODE <sup>[4]</sup>	CATHODE <sup>[5]</sup>
2	CATHODE f	ANODE f	CATHODE PLUS	ANODE PLUS
3	CATHODE g	ANODE g	CATHODE MINUS	ANODE MINUS
4	CATHODE e	ANODE e	NC	NC
5	CATHODE d	ANODE d	NC	NC
6	ANODE <sup>[4]</sup>	CATHODE <sup>[5]</sup>	ANODE <sup>[4]</sup>	CATHODE <sup>[5]</sup>
7	CATHODE DP	ANODE DP	CATHODE DP	ANODE DP
8	CATHODE c	ANODE c	CATHODE c	ANODE c
9	CATHODE b	ANODE b	CATHODE b	ANODE b
10	CATHODE a	ANODE a	NC	NC

### NOTES:

1. ALL DIMENSIONS IN MILLIMETRES (INCHES).
2. MAXIMUM.
3. ALL UNTOLERANCED DIMENSIONS ARE FOR REFERENCE ONLY.
4. REDUNDANT ANODES.
5. REDUNDANT CATHODES.

# Package Dimensions (cont.)

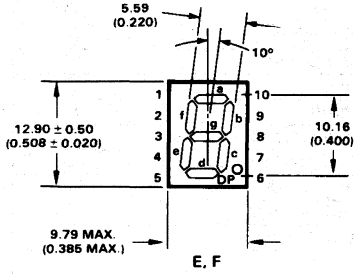

E, F

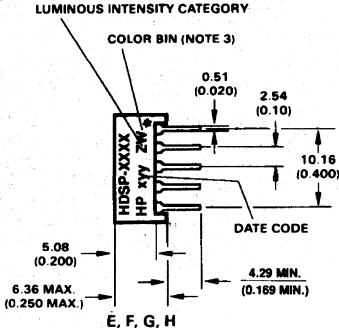

E, F, G, H

\* The Side View of package indicates Country of Origin.

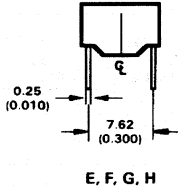

E, F, G, H

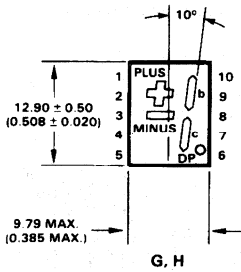

G, H

PIN	FUNCTION			
	E	F	G	H
1	ANODE <sup>(4)</sup>	CATHODE <sup>(5)</sup>	ANODE <sup>(4)</sup>	CATHODE <sup>(5)</sup>
2	CATHODE f	ANODE f	CATHODE PLUS	ANODE PLUS
3	CATHODE g	ANODE g	CATHODE MINUS	ANODE MINUS
4	CATHODE e	ANODE e	NC	NC
5	CATHODE d	ANODE d	NC	NC
6	ANODE <sup>(4)</sup>	CATHODE <sup>(5)</sup>	ANODE <sup>(4)</sup>	CATHODE <sup>(5)</sup>
7	CATHODE DP	ANODE DP	CATHODE DP	ANODE DP
8	CATHODE c	ANODE c	CATHODE c	ANODE c
9	CATHODE b	ANODE b	CATHODE b	ANODE b
10	CATHODE a	ANODE a	NC	NC

## NOTES:

1. ALL DIMENSIONS IN MILLIMETRES (INCHES).
2. ALL UNTOLERANCED DIMENSIONS ARE FOR REFERENCE ONLY.
3. FOR YELLOW AND GREEN SERIES PRODUCT ONLY.
4. REDUNDANT ANODES.
5. REDUNDANT CATHODES.

# Package Dimensions (cont.)

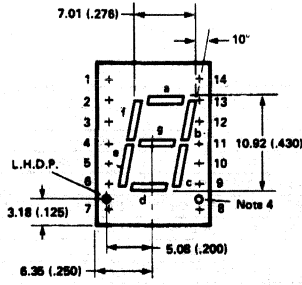

**I**  
FRONT VIEW

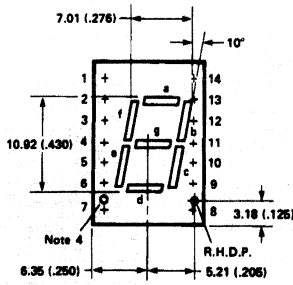

**J, K**  
FRONT VIEW

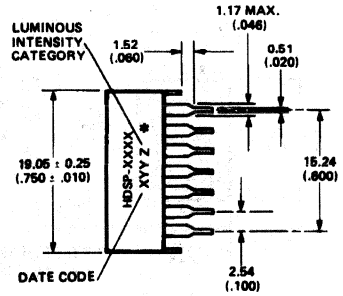

**SIDE VIEW**

\*The Side View of package indicates Country of Origin.

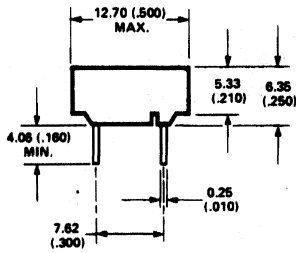

**END VIEW**

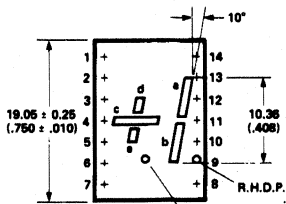

**NOTE [4]**

**L**

PIN	FUNCTION			
	I	J	K	L
1	CATHODE-a	CATHODE-a	ANODE-a	CATHODE-d
2	CATHODE-f	CATHODE-f	ANODE-f	ANODE-d
3	ANODE [3]	ANODE [3]	CATHODE [6]	NO PIN
4	NO PIN	NO PIN	NO PIN	CATHODE-c
5	NO PIN	NO PIN	NO PIN	CATHODE-e
6	CATHODE-dp	NO CONN. [8]	NO CONN. [8]	ANODE-a
7	CATHODE-e	CATHODE-e	ANODE-e	ANODE-c
8	CATHODE-d	CATHODE-d	ANODE-d	ANODE-dp
9	NO CONN. [8]	CATHODE-dp	ANODE-dp	CATHODE-dp
10	CATHODE-c	CATHODE-c	ANODE-c	CATHODE-b
11	CATHODE-g	CATHODE-g	ANODE-g	CATHODE-a
12	NO PIN	NO PIN	NO PIN	NO PIN
13	CATHODE-b	CATHODE-b	ANODE-b	ANODE-a
14	ANODE [3]	ANODE [3]	CATHODE [6]	ANODE-b

**NOTES:**

1. ALL DIMENSIONS IN MILLIMETRES (INCHES).
2. ALL UNTOLERANCED DIMENSIONS ARE FOR REFERENCE ONLY.
3. REDUNDANT ANODES.
4. UNUSED dp POSITION.
5. SEE INTERNAL CIRCUIT DIAGRAM.
6. REDUNDANT CATHODES.
7. SEE PART NUMBER TABLE FOR L.H.D.P. AND R.H.D.P. DESIGNATION.

SEVEN SEGMENT NUMERIC DISPLAYS

# Package Dimensions (cont.)

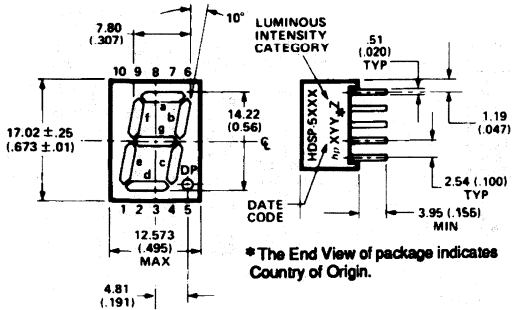

\*The End View of package indicates Country of Origin.

PIN	FUNCTION			
	M	N	O	P
1	CATHODE e	ANODE e	CATHODE c	ANODE c
2	CATHODE d	ANODE d	ANODE c, d	CATHODE c, d
3	ANODE[4]	CATHODE[5]	CATHODE b	ANODE b
4	CATHODE c	ANODE c	ANODE a, b, DP	CATHODE a, b, DP
5	CATHODE DP	ANODE DP	CATHODE DP	ANODE DP
6	CATHODE b	ANODE b	CATHODE a	ANODE a
7	CATHODE a	ANODE a	ANODE a, b, DP	CATHODE a, b, DP
8	ANODE[4]	CATHODE[5]	ANODE c, d	CATHODE c, d
9	CATHODE f	ANODE f	CATHODE d	ANODE d
10	CATHODE g	ANODE g	NO PIN	NO PIN

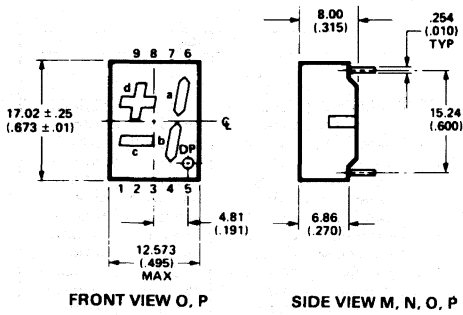

### NOTES:

1. ALL DIMENSIONS IN MILLIMETRES (INCHES).
2. MAXIMUM.
3. ALL UNTOLERANCED DIMENSIONS ARE FOR REFERENCE ONLY.
4. REDUNDANT ANODES.
5. REDUNDANT CATHODES.

## Package Dimensions (cont.)

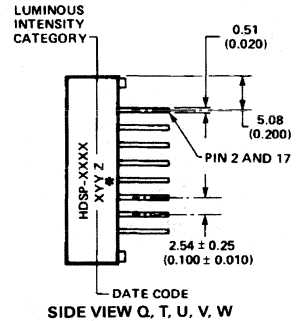
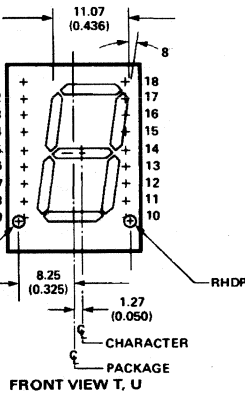
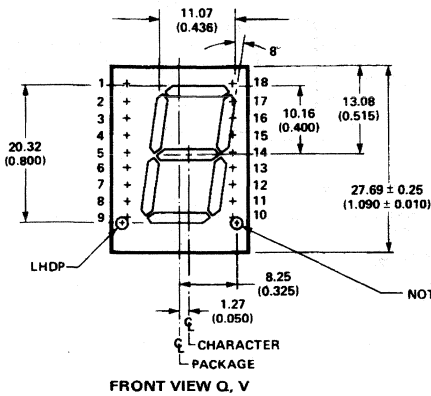

\* The Side View of package indicates Country of Origin.

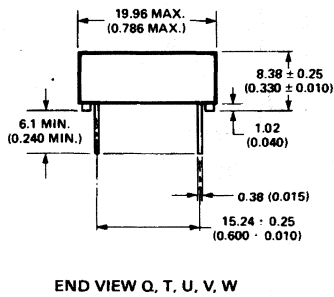

Pin	Function				
	Q	T	U	V	W
1	NO PIN	NO PIN	NO PIN	NO PIN	NO PIN
2	CATHODE a	CATHODE a	ANODE a	ANODE a	CATHODE a
3	CATHODE f	CATHODE f	ANODE f	ANODE f	ANODE g
4	ANODE <sup>(3)</sup>	ANODE <sup>(3)</sup>	CATHODE <sup>(6)</sup>	CATHODE <sup>(6)</sup>	CATHODE d
5	CATHODE e	CATHODE e	ANODE e	ANODE e	CATHODE c
6	ANODE <sup>(3)</sup>	ANODE <sup>(3)</sup>	CATHODE <sup>(6)</sup>	CATHODE <sup>(6)</sup>	CATHODE e
7	CATHODE dp	NO. CONNEC	NO. CONNEC	ANODE dp	ANODE e
8	NO PIN	NO PIN	NO PIN	NO PIN	CATHODE dp
9	NO PIN	NO PIN	NO PIN	NO PIN	NO PIN
10	NO PIN	CATHODE dp	ANODE dp	NO PIN	ANODE dp
11	CATHODE d	CATHODE d	ANODE d	ANODE d	CATHODE dp
12	ANODE <sup>(3)</sup>	ANODE <sup>(3)</sup>	CATHODE <sup>(6)</sup>	CATHODE <sup>(6)</sup>	CATHODE b
13	CATHODE c	CATHODE c	ANODE c	ANODE c	ANODE b
14	CATHODE g	CATHODE g	ANODE g	ANODE g	ANODE c
15	CATHODE b	CATHODE b	ANODE b	ANODE b	ANODE a
16	NO PIN	NO PIN	NO PIN	NO PIN	NO PIN
17	ANODE <sup>(3)</sup>	ANODE <sup>(3)</sup>	CATHODE <sup>(6)</sup>	CATHODE <sup>(6)</sup>	CATHODE a
18	NO PIN	NO PIN	NO PIN	NO PIN	NO PIN

### NOTES:

1. ALL DIMENSIONS IN MILLIMETRES (INCHES).
2. ALL UNTOLERANCED DIMENSIONS ARE FOR REFERENCE ONLY.
3. REDUNDANT ANODES.
4. UNUSED dp POSITION.
5. SEE INTERNAL CIRCUIT DIAGRAM.
6. REDUNDANT CATHODES.
7. SEE PART NUMBER TABLE FOR L.H.D.P. AND R.H.D.P. DESIGNATION.

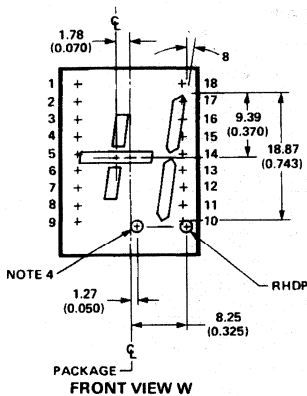

SEVEN SEGMENT  
NUMERIC DISPLAYS

## Package Dimensions (cont.)

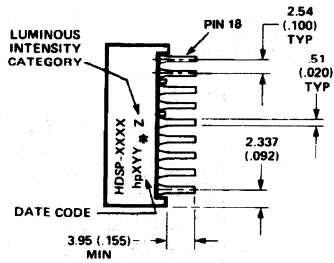

TOP END VIEW R, S

\*The Side View of package indicates Country of Origin.

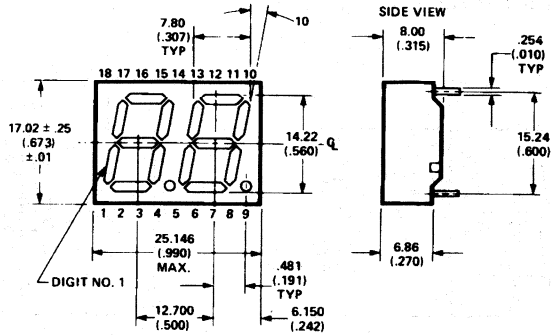

FRONT VIEW R, S

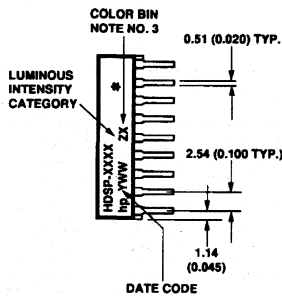

TOP END VIEW X, Y

\*The Side View of package indicates Country of Origin.

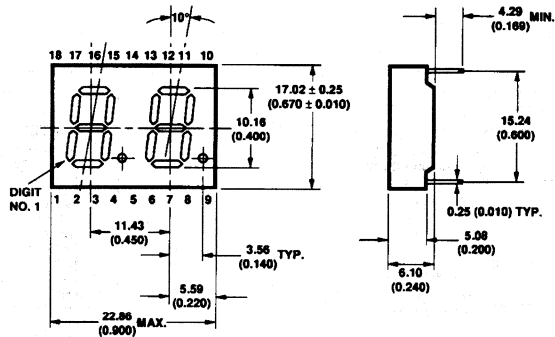

FRONT VIEW X, Y

Pin	Function	
	R,X	S,Y
1	E CATHODE NO. 1	E ANODE NO. 1
2	D CATHODE NO. 1	D ANODE NO. 1
3	C CATHODE NO. 1	C ANODE NO. 1
4	DP CATHODE NO. 1	DP ANODE NO. 1
5	E CATHODE NO. 2	E ANODE NO. 2
6	D CATHODE NO. 2	D ANODE NO. 2
7	G CATHODE NO. 2	G ANODE NO. 2
8	C CATHODE NO. 2	C ANODE NO. 2
9	DP CATHODE NO. 2	DP ANODE NO. 2
10	B CATHODE NO. 2	B ANODE NO. 2
11	A CATHODE NO. 2	A ANODE NO. 2
12	F CATHODE NO. 2	F ANODE NO. 2
13	DIGIT NO. 2 ANODE	DIGIT NO. 2 CATHODE
14	DIGIT NO. 1 ANODE	DIGIT NO. 1 CATHODE
15	B CATHODE NO. 1	B ANODE NO. 1
16	A CATHODE NO. 1	A ANODE NO. 1
17	G CATHODE NO. 1	G ANODE NO. 1
18	F CATHODE NO. 1	F ANODE NO. 1

### NOTES:

1. DIMENSIONS ARE IN MILLIMETRES (INCHES).
2. ALL UNTOLERANCED DIMENSIONS ARE FOR REFERENCE ONLY.
3. WHERE APPLICABLE.

# Internal Circuit Diagram

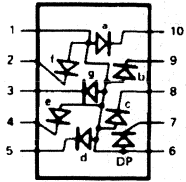

A, E

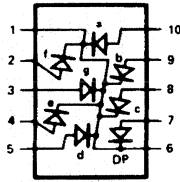

B, F

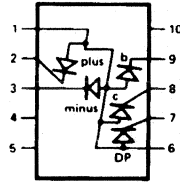

C, G

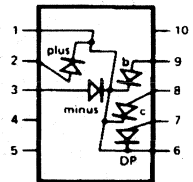

D, H

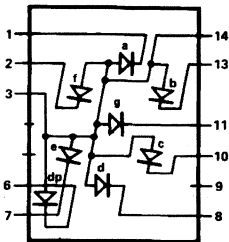

I

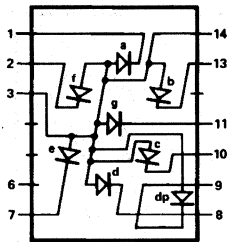

J

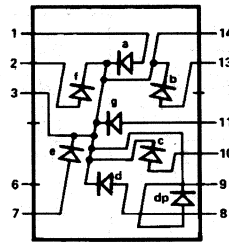

K

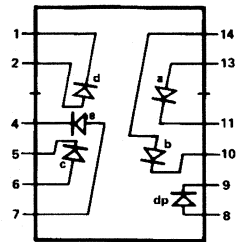

L

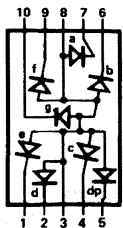

M

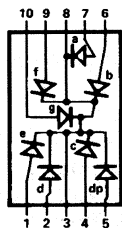

N

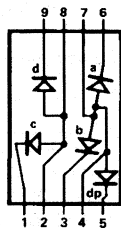

O

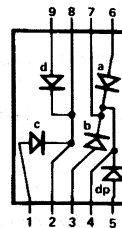

P

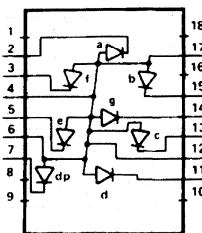

Q

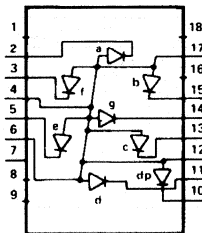

T

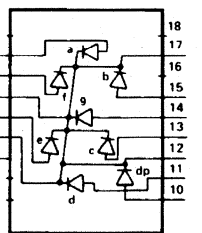

U

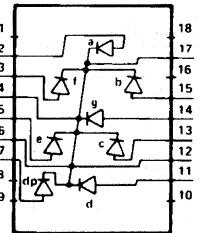

V

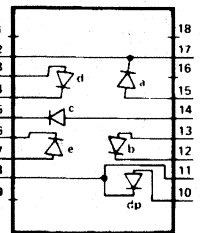

W

SEVEN SEGMENT  
NUMERIC DISPLAYS

### Internal Circuit Diagram (cont.)

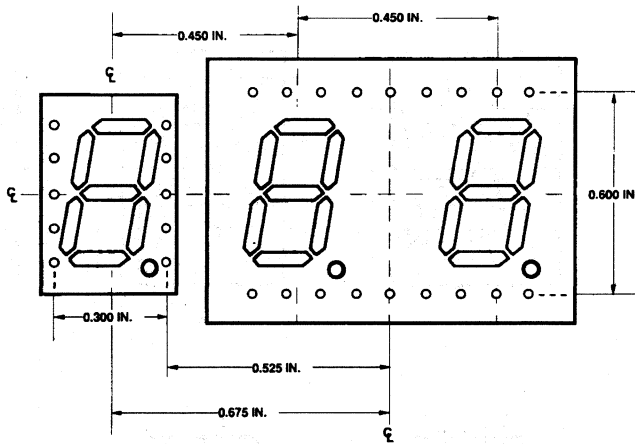
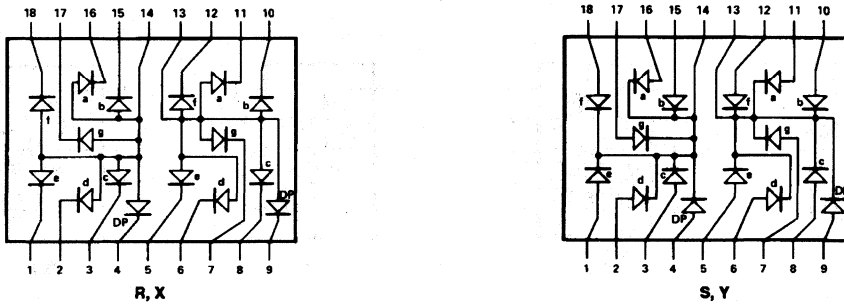

HOLE PATTERN FOR PCB LAYOUT TO ACHIEVE UNIFORM 0.450 in. DIGIT TO DIGIT PITCH. FOR HDSP-FXXX TO HDSP-GXXX.

### Absolute Maximum Ratings

Description	AlGaAs Red HDSP-A10X/E10X/ H10X/K12X/N10X/ F10X, G10X Series	HER HDSP-751X/ 335X/555X/ K70X Series	Yellow HDSP-A80X Series	Green HDSP-A90X Series	Units
Average Power per Segment or DP	37	52		64	mW
Peak Forward Current per Segment or DP	45				mA
DC Forward Current per Segment or DP	15 <sup>[1]</sup>	15 <sup>[2]</sup>			mA
Operating Temperature Range	-20 to +100	-40 to +100			°C
Storage Temperature Range	-55 to +100				°C
Reverse Voltage per Segment or DP	3.0				V
Lead Solder Temperature for 3 Seconds (1.60 mm [0.063 in.] below seating plane)	260				°C

#### Notes:

1. Derate above 91°C at 0.53 mA/°C.
2. Derate HER/Yellow above 80°C at 0.38 mA/°C and Green above 71°C at 0.31 mA/°C.



## Electrical/Optical Characteristics at $T_A = 25^\circ\text{C}$

### AlGaAs Red

Device Series HDSP-	Parameter	Symbol	Min.	Typ.	Max.	Units	Test Conditions			
A10X	Luminous Intensity/Segment <sup>[1,2]</sup> (Digit Average)	$I_V$	315	600		$\mu\text{cd}$	$I_F = 1 \text{ mA}$			
F10X, G10X				3600				$I_F = 5 \text{ mA}$		
				330	650			$I_F = 1 \text{ mA}$		
E10X				3900				$I_F = 5 \text{ mA}$		
				390	650			$I_F = 1 \text{ mA}$		
H10X, K12X				3900				$I_F = 5 \text{ mA}$		
				400	700			$I_F = 1 \text{ mA}$		
N10X				4200				$I_F = 5 \text{ mA}$		
				270	590			$I_F = 1 \text{ mA}$		
All Devices			Forward Voltage/Segment or DP	$V_F$			1.6		V	$I_F = 1 \text{ mA}$
							1.7			$I_F = 5 \text{ mA}$
							1.8	2.2		$I_F = 20 \text{ mA Pk}$
	Peak Wavelength	$\lambda_{\text{PEAK}}$		645		nm				
	Dominant Wavelength <sup>[3]</sup>	$\lambda_d$		637		nm				
	Reverse Voltage/Segment or DP <sup>[4]</sup>	$V_R$	3.0	15		V	$I_R = 100 \text{ mA}$			
	Temperature Coefficient of $V_F$ /Segment or DP	$\Delta V_F/^\circ\text{C}$		-2 mV		mV/°C				
A10X	Thermal Resistance LED Junction-to-Pin	$R_{\theta_{J-PIN}}$		255		°C/W/Seg				
F10X, G10X				320						
E10X				340						
H10X, K12X				400						
N10X				430						

SEVEN SEGMENT  
NUMERIC DISPLAYS

### High Efficiency Red

Device Series HDSP-	Parameter	Symbol	Min.	Typ.	Max.	Units	Test Conditions
751X	Luminous Intensity/Segment <sup>[1,2]</sup> (Digit Average)	$I_V$	160	270		mcd	$I_F = 2 \text{ mA}$
				1050			$I_F = 5 \text{ mA}$
335X, 555X, K70X			200	300			$I_F = 2 \text{ mA}$
				1200			$I_F = 5 \text{ mA}$
			270	370			$I_F = 2 \text{ mA}$
				1480			$I_F = 5 \text{ mA}$
All Devices	Forward Voltage/Segment or DP	$V_F$		1.6		V	$I_F = 2 \text{ mA}$
				1.7			$I_F = 5 \text{ mA}$
				2.1	2.5		$I_F = 20 \text{ mA Pk}$
	Peak Wavelength	$\lambda_{PEAK}$		635		nm	
	Dominant Wavelength <sup>[3]</sup>	$\lambda_d$		626		nm	
	Reverse Voltage/Segment or DP <sup>[4]</sup>	$V_R$	3.0	30		V	$I_R = 100 \text{ mA}$
	Temperature Coefficient of $V_F$ /Segment or DP	$\Delta V_F/^\circ\text{C}$		-2		mV/°C	
751X	Thermal Resistance LED Junction-to-Pin	$R\theta_{J-PIN}$		200		°C/W	
335X				280			
555X, K70X				345			

## Yellow

Device Series HDSP-	Parameter	Symbol	Min.	Typ.	Max.	Units	Test Conditions
A80X	Luminous Intensity/Segment <sup>[1,2]</sup> (Digit Average)	I <sub>V</sub>	250	420		mcd	I <sub>F</sub> = 4 mA
				1300			I <sub>F</sub> = 10 mA
	Forward Voltage/Segment or DP	V <sub>F</sub>		1.7		V	I <sub>F</sub> = 4 mA
				1.8			I <sub>F</sub> = 5 mA
				2.1	2.5		I <sub>F</sub> = 20 mA Pk
	Peak Wavelength	λ <sub>PEAK</sub>		583		nm	
	Dominant Wavelength <sup>[3,5]</sup>	λ <sub>d</sub>	581.5	585	592.5	nm	
	Reverse Voltage/Segment or DP <sup>[4]</sup>	V <sub>R</sub>	3.0	30		V	I <sub>R</sub> = 100 mA
Temperature Coefficient of V <sub>F</sub> /Segment or DP	ΔV <sub>F</sub> /°C		-2		mV/°C		
Thermal Resistance LED Junction-to-Pin	Rθ <sub>J-PIN</sub>		200		°C/W		

## Green

Device Series HDSP-	Parameter	Symbol	Min.	Typ.	Max.	Units	Test Conditions
A90X	Luminous Intensity/Segment <sup>[1,2]</sup> (Digit Average)	I <sub>V</sub>	250	475		mcd	I <sub>F</sub> = 4 mA
				1500			I <sub>F</sub> = 10 mA
	Forward Voltage/Segment or DP	V <sub>F</sub>		1.9		V	I <sub>F</sub> = 4 mA
				2.0			I <sub>F</sub> = 10 mA
				2.1	2.5		I <sub>F</sub> = 20 mA Pk
	Peak Wavelength	λ <sub>PEAK</sub>		566		nm	
	Dominant Wavelength <sup>[3,5]</sup>	λ <sub>d</sub>		571	577	nm	
	Reverse Voltage/Segment or DP <sup>[4]</sup>	V <sub>R</sub>	3.0	30		V	I <sub>R</sub> = 100 mA
Temperature Coefficient of V <sub>F</sub> /Segment or DP	ΔV <sub>F</sub> /°C		-2		mV/°C		
Thermal Resistance LED Junction-to-Pin	Rθ <sub>J-PIN</sub>		200		°C/W		

### Notes:

1. Device case temperature is 25°C prior to the intensity measurement.
2. The digits are categorized for luminous intensity. The intensity category is designated by a letter on the side of the package.
3. The dominant wavelength, λ<sub>d</sub>, is derived from the CIE chromaticity diagram and is the single wavelength which defines the color of the device.
4. Typical specification for reference only. Do not exceed absolute maximum ratings.
5. The yellow (HDSP-A800) and Green (HDSP-A900) displays are categorized for dominant wavelength. The category is designated by a number adjacent to the luminous intensity category letter.

# AlGaAs Red

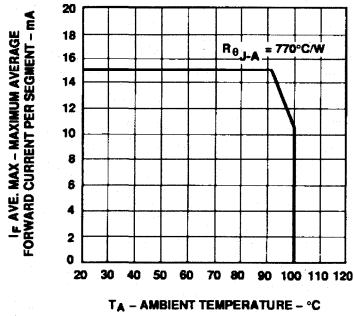

Figure 1. Maximum Allowable Average or DC Current vs. Ambient Temperature.

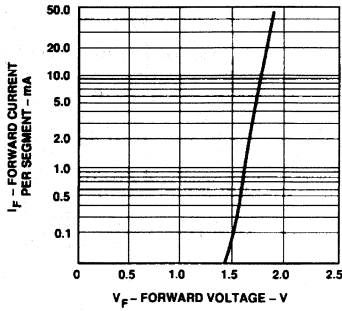

Figure 2. Forward Current vs. Forward Voltage.

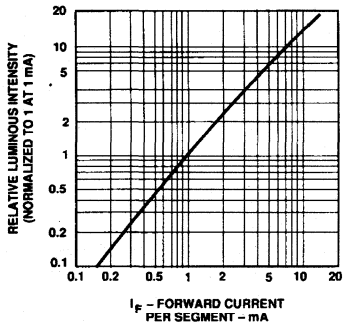

Figure 3. Relative Luminous Intensity vs. DC Forward Current.

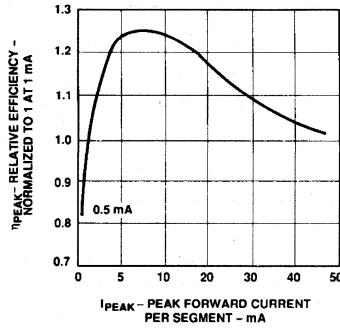

Figure 4. Relative Efficiency (Luminous Intensity per Unit Current) vs. Peak Current.

## HER, Yellow, Green

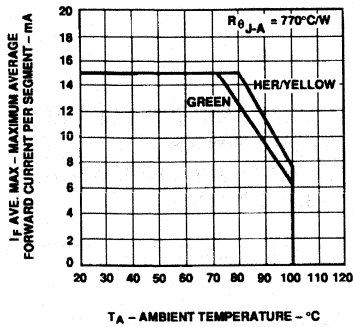

Figure 5. Maximum Allowable Average or DC Current vs. Ambient Temperature.

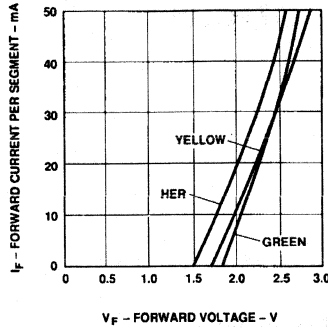

Figure 6. Forward Current vs. Forward Voltage.

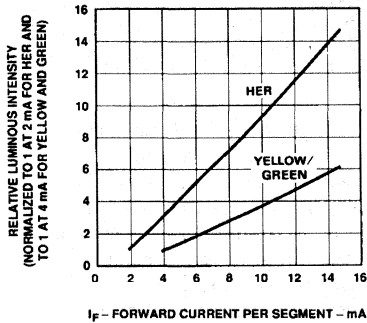

Figure 7. Relative Luminous Intensity vs. DC Forward Current.

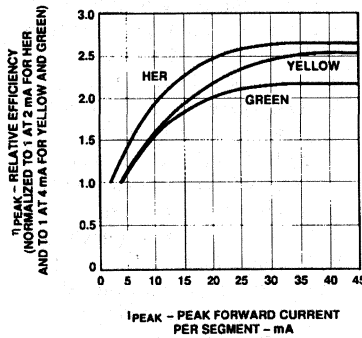

Figure 8. Relative Efficiency (Luminous Intensity per Unit Current) vs. Peak Current.

### Electrical/Optical

For more information on electrical/optical characteristics, please see Application Note 1005.

### Contrast Enhancement

For information on contrast enhancement please see Application Note 1015.

### Soldering/Cleaning

Cleaning agents from the ketone family (acetone, methyl ethyl ketone, etc.) and from the

chlorinated hydrocarbon family (methylene chloride, trichloroethylene, carbon tetrachloride, etc.) are not recommended for cleaning LED parts. All of these various solvents attack or dissolve the encapsulating epoxies used to form the package of plastic LED parts.

For information on soldering LEDs please refer to Application Note 1027.

---

# Seven Segment Displays for High Light Ambient Conditions

## Technical Data

**HDSP-3530/-3730/-5530/  
-3900 Series**  
**HDSP-4030/-4130/-5730/  
-4200 Series**

---

### Features

- **High Light Output**  
Typical Intensities of Up to 7.0 mcd/seg at 100 mA pk 1 of 5 Duty Factor
- **Capable of High Current Drive**  
Excellent for Long Digit String Multiplexing
- **Four Character Sizes**  
7.6 mm, 10.9 mm, 14.2 mm, and 20.3 mm
- **Choice of Two Colors**  
High Efficiency Red  
Yellow
- **Excellent Character Appearance**  
Evenly Lighted Segments  
Wide Viewing Angle  
Gray Body for Optimum Contrast
- **Categorized for Luminous Intensity; Yellow Categorized for Color**  
Use of Like Categories Yields a Uniform Display
- **IC Compatible**
- **Mechanically Rugged**

### Description

The HDSP-3530/-3730/-5530/-3900 and HDSP-4030/-4130/-5730/-4200 are 7.6 mm, 10.9 mm/14.2 mm/20.3 mm high efficiency red and yellow displays designed for use in high light ambient condition. The four sizes of displays allow for viewing distances at 3, 6, 7, and 10 meters. These seven segment displays utilize large junction high efficiency LED chips made from GaAsP on a transparent GaP substrate. Due to the large junction area, these displays can be driven at high peak current levels needed for high ambient conditions or many character multiplexed operation.

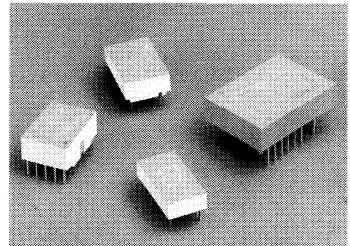

These displays have industry standard packages, and pin configurations and  $\pm 1$  overflow display are available in all four sizes. These numeric displays are ideal for applications such as Automotive and Avionic Instrumentation, Point of Sale Terminals, and Gas Pump.

## Devices

Part No. HDSP-	Color	Description	Package Drawing
3530	High Efficiency Red	7.6 mm Common Anode Left Hand Decimal	A
3531		7.6 mm Common Anode Right Hand Decimal	B
3533		7.6 mm Common Cathode Right Hand Decimal	C
3536		7.6 mm Universal Overflow $\pm$ 1 Right Hand Decimal	D
4030	Yellow	7.6 mm Common Anode Left Hand Decimal	A
4031		7.6 mm Common Anode Right Hand Decimal	B
4033		7.6 mm Common Cathode Right Hand Decimal	C
4036		7.6 mm Universal Overflow $\pm$ 1 Right Hand Decimal	D
3730	High Efficiency Red	10.9 mm Common Anode Left Hand Decimal	E
3731		10.9 mm Common Anode Right Hand Decimal	F
3733		10.9 mm Common Cathode Right Hand Decimal	G
3736		10.9 mm Universal Overflow $\pm$ 1 Right Hand Decimal	H
4130	Yellow	10.9 mm Common Anode Left Hand Decimal	E
4131		10.9 mm Common Anode Right Hand Decimal	F
4133		10.9 mm Common Cathode Right Hand Decimal	G
4136		10.9 mm Universal Overflow $\pm$ 1 Right Hand Decimal	H
5531	High Efficiency Red	14.2 mm Common Anode Right Hand Decimal	I
5533		14.2 mm Common Cathode Right Hand Decimal	J
5537		14.2 mm Overflow $\pm$ 1 Common Anode	K
5538		14.1 mm Overflow $\pm$ 1 Common Cathode	L
5731	Yellow	14.2 mm Common Anode Right Hand Decimal	I
5733		14.2 mm Common Cathode Right Hand Decimal	J
5737		14.2 mm Overflow $\pm$ 1 Common Anode	K
5738		14.1 mm Overflow $\pm$ 1 Common Cathode	L
3900	High Efficiency Red	20.3 mm Common Left Hand Decimal	M
3901		20.3 mm Common Anode Right Hand Decimal	N
3903		20.3 mm Common Cathode Right Hand Decimal	O
3905		20.3 mm Common Cathode Left Hand Decimal	P
3906		20.3 mm Universal Overflow $\pm$ 1 Right Hand Decimal	Q
4200	Yellow	20.3 mm Common Left Hand Decimal	M
4201		20.3 mm Common Anode Right Hand Decimal	N
4203		20.3 mm Common Cathode Right Hand Decimal	O
4205		20.3 mm Common Cathode Left Hand Decimal	P
4206		20.3 mm Universal Overflow $\pm$ 1 Right Hand Decimal	Q

**Note:** Universal pinout brings the anode and cathode of each segment's LED out to separate pins. See internal diagrams D and H.

### Absolute Maximum Ratings (All Products)

Average Power per Segment or DP ( $T_A = 25^\circ\text{C}$ ) .....	105 mW
Peak Forward Current per Segment or DP ( $T_A = 25^\circ\text{C}$ ) .....	135 mA (Pulse Width = 0.16 ms)
DC Forward Current per Segment <sup>[2]</sup> or DP ( $T_A = 25^\circ\text{C}$ ) .....	40 mA
Operating Temperature Range .....	$-40^\circ\text{C}$ to $+85^\circ\text{C}$
Storage Temperature Range .....	$-40^\circ\text{C}$ to $+85^\circ\text{C}$
Reverse Voltage per Segment or DP .....	5.0 V
Lead Solder Temperature (1.59 mm [1/16 inch] below seating plane) .....	$260^\circ\text{C}$ for 3 sec

**Notes:**

1. See Figure 1 to establish pulsed operating conditions
2. Derate maximum DC current above  $T_A = 25^\circ\text{C}$  at 0.50 mA/ $^\circ\text{C}$  per segment, see Figure 2.

## Package Dimensions (HDSP-3530/-4030 Series)

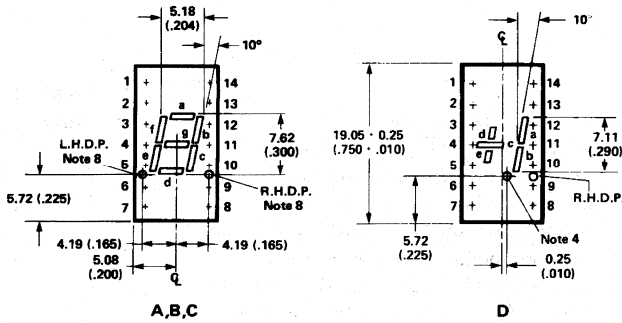

	FUNCTION			
	A -3530/-4030	B -3531/-4031	C -3533/-4033	D -3536/-4036
1	CATHODE-a	CATHODE-a	CATHODE <sup>[6]</sup>	ANODE-d
2	CATHODE-f	CATHODE-f	ANODE-f	NO PIN
3	ANODE <sup>[3]</sup>	ANODE <sup>[3]</sup>	ANODE-g	CATHODE-d
4	NO PIN	NO PIN	ANODE-e	CATHODE-c
5	NO PIN	NO PIN	ANODE-d	CATHODE-e
6	CATHODE-dp	NO CONN. <sup>[5]</sup>	CATHODE <sup>[6]</sup>	ANODE-e
7	CATHODE-e	CATHODE-e	ANODE-dp	ANODE-c
8	CATHODE-d	CATHODE-d	ANODE-c	ANODE-dp
9	NO CONN. <sup>[5]</sup>	CATHODE-dp	ANODE-b	NO PIN
10	CATHODE-c	CATHODE-c	ANODE-a	CATHODE-dp
11	CATHODE-g	CATHODE-g		CATHODE-b
12	NO PIN	NO PIN		CATHODE-a
13	CATHODE-b	CATHODE-b		ANODE-a
14	ANODE <sup>[3]</sup>	ANODE <sup>[3]</sup>		ANODE-b

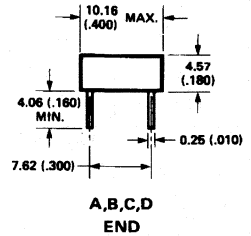
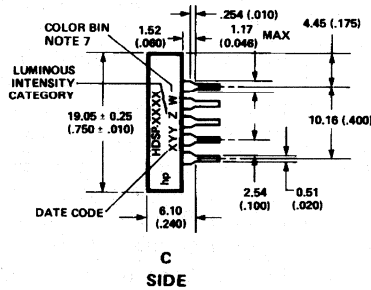
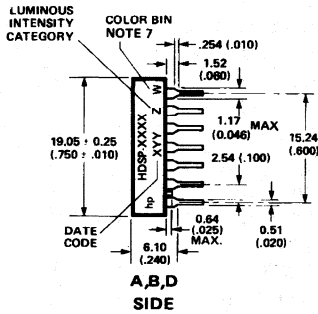

## Package Dimensions (HDSP-3730/-4130 Series)

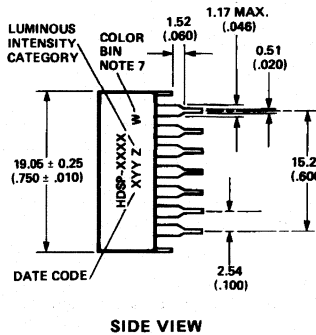
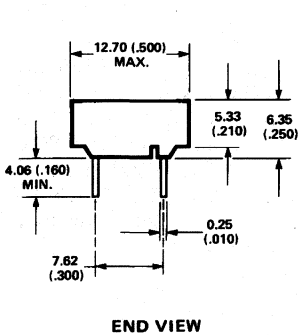
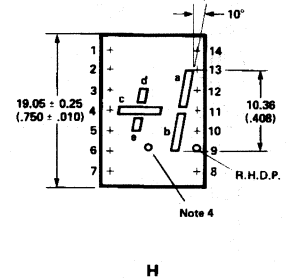
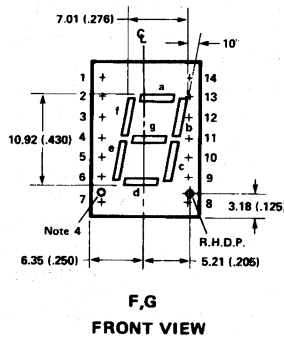
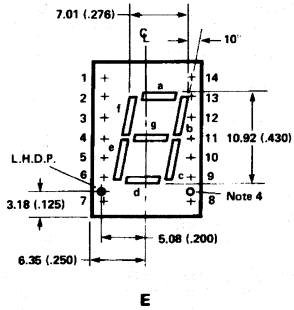

PIN	FUNCTION			
	E -3730/-4130	F -3731/-4131	G -3733/-4133	H -3736/-4136
1	CATHODE-a	CATHODE-a	ANODE-a	CATHODE-d
2	CATHODE-f	CATHODE-f	ANODE-f	ANODE-d
3	ANODE <sup>[3]</sup>	ANODE <sup>[3]</sup>	CATHODE <sup>[6]</sup>	NO PIN
4	NO PIN	NO PIN	NO PIN	CATHODE-c
5	NO PIN	NO PIN	NO PIN	CATHODE-e
6	CATHODE-dp	NO CONN. <sup>[5]</sup>	NO CONN. <sup>[5]</sup>	ANODE-e
7	CATHODE-e	CATHODE-e	ANODE-a	ANODE-c
8	CATHODE-d	CATHODE-d	ANODE-d	ANODE-dp
9	NO CONN. <sup>[5]</sup>	CATHODE-dp	ANODE-dp	CATHODE-dp
10	CATHODE-c	CATHODE-c	ANODE-c	CATHODE-b
11	CATHODE-g	CATHODE-g	ANODE-g	CATHODE-a
12	NO PIN	NO PIN	NO PIN	NO PIN
13	CATHODE-b	CATHODE-b	ANODE-b	ANODE-a
14	ANODE <sup>[3]</sup>	ANODE <sup>[3]</sup>	CATHODE <sup>[6]</sup>	ANODE-b



## Package Dimensions (-5530/-5730 Series)

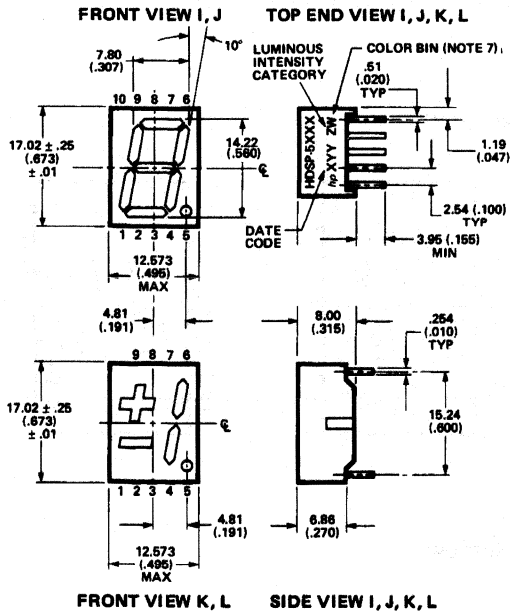

PIN	FUNCTION			
	I 5531	J 5533	K 5537	L 5538
1	CATHODE a	ANODE e	CATHODE c	ANODE c
2	CATHODE d	ANODE d	ANODE c, d	CATHODE c, d
3	ANODE <sup>(3)</sup>	CATHODE <sup>(6)</sup>	CATHODE b	ANODE b
4	CATHODE c	ANODE c	ANODE a, b	CATHODE a, b, DP
5	CATHODE DP	ANODE DP	CATHODE DP	ANODE DP
6	CATHODE b	ANODE b	CATHODE a	ANODE a
7	CATHODE a	ANODE a	CATHODE a, b, DP	CATHODE a, b, DP
8	ANODE <sup>(3)</sup>	CATHODE <sup>(6)</sup>	ANODE c, d	CATHODE c, d
9	CATHODE f	ANODE f	CATHODE d	ANODE d
10	CATHODE g	ANODE g	NO PIN <sup>(5)</sup>	NO PIN <sup>(5)</sup>

## Package Dimensions (-3900/-4200 Series)

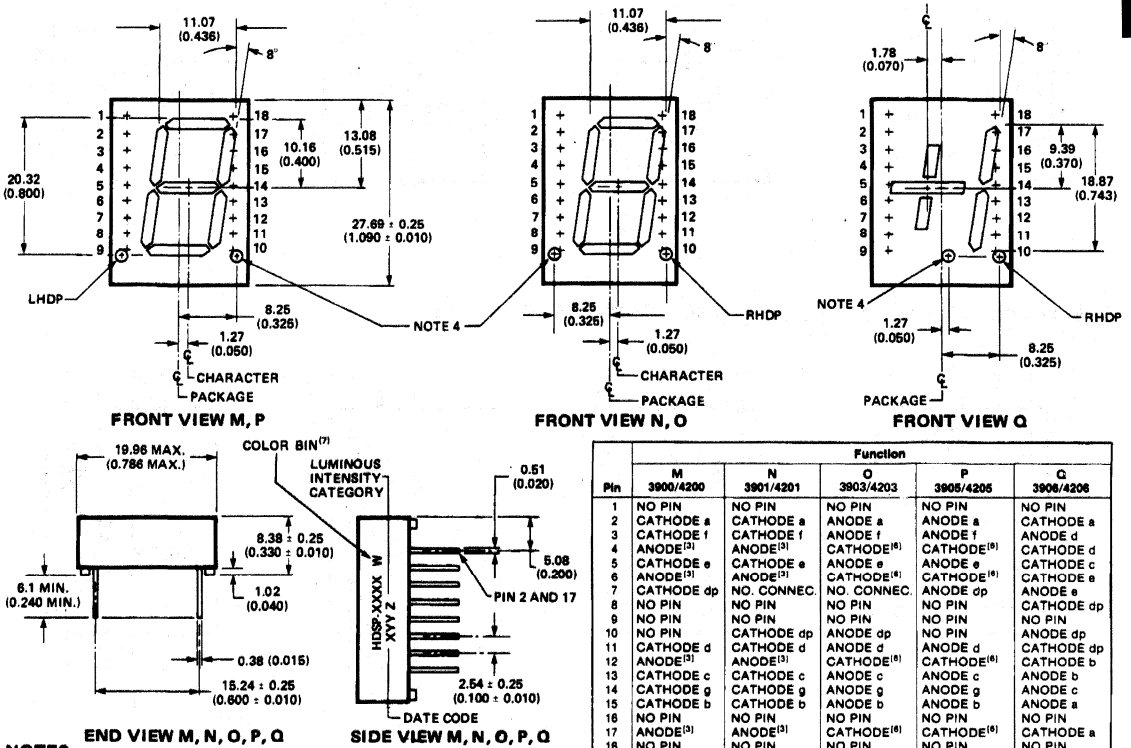

Pin	Function				
	M 3900/4200	N 3901/4201	O 3903/4203	P 3905/4205	Q 3906/4206
1	NO PIN	NO PIN	NO PIN	NO PIN	NO PIN
2	CATHODE a	CATHODE a	ANODE a	ANODE a	CATHODE a
3	CATHODE f	CATHODE f	ANODE f	ANODE f	ANODE d
4	ANODE <sup>(3)</sup>	CATHODE <sup>(6)</sup>	CATHODE <sup>(6)</sup>	CATHODE <sup>(6)</sup>	CATHODE d
5	CATHODE e	ANODE e	ANODE e	ANODE e	CATHODE c
6	ANODE <sup>(3)</sup>	ANODE <sup>(3)</sup>	CATHODE <sup>(6)</sup>	CATHODE <sup>(6)</sup>	CATHODE a
7	CATHODE dp	NO. CONNec.	NO. CONNec.	ANODE dp	ANODE a
8	NO PIN	NO PIN	NO PIN	NO PIN	CATHODE dp
9	NO PIN	NO PIN	NO PIN	NO PIN	NO PIN
10	NO PIN	CATHODE dp	ANODE dp	NO PIN	ANODE dp
11	CATHODE d	ANODE d	ANODE d	ANODE d	CATHODE dp
12	ANODE <sup>(3)</sup>	CATHODE <sup>(6)</sup>	CATHODE <sup>(6)</sup>	CATHODE <sup>(6)</sup>	CATHODE b
13	CATHODE c	CATHODE c	ANODE c	ANODE c	ANODE b
14	CATHODE g	CATHODE g	ANODE g	ANODE g	ANODE c
15	CATHODE b	CATHODE b	ANODE b	ANODE b	ANODE a
16	NO PIN	NO PIN	NO PIN	NO PIN	NO PIN
17	ANODE <sup>(3)</sup>	ANODE <sup>(3)</sup>	CATHODE <sup>(6)</sup>	CATHODE <sup>(6)</sup>	CATHODE a
18	NO PIN	NO PIN	NO PIN	NO PIN	NO PIN

### NOTES:

- Dimensions in millimeters and (inches).
- All untoleranced dimensions are for reference only.
- Redundant anodes.
- Unused dp position.
- See Internal Circuit Diagram.
- Redundant Cathodes.
- For HDSP-4030/-4130/-5731/-4200 Series product only.
- See part number table for LHDP and RHDP designation.

SEVEN SEGMENT NUMERIC DISPLAYS

**Internal Circuit Diagram (HDSP-3530/-4030 Series)**

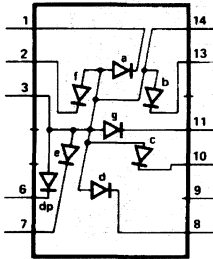

**A**

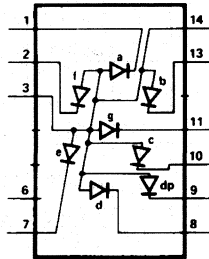

**B**

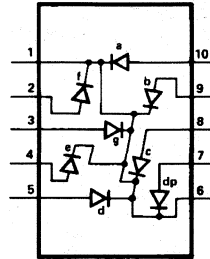

**C**

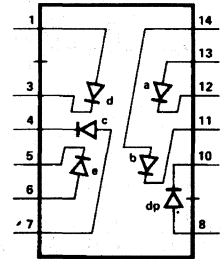

**D**

**Internal Circuit Diagram (HDSP-3730/-4130 Series)**

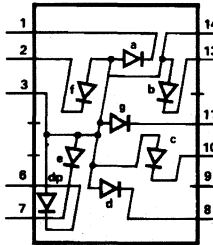

**E**

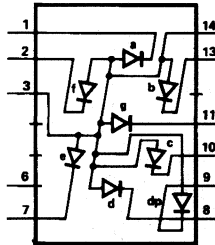

**F**

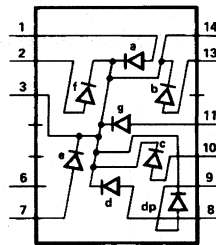

**G**

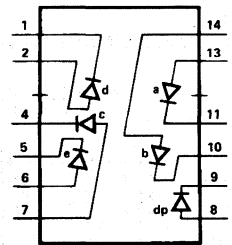

**H**

**Internal Circuit Diagram (HDSP-5530/-5730 Series)**

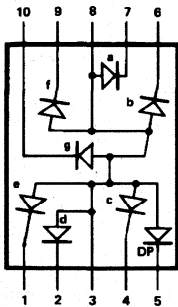

**I**

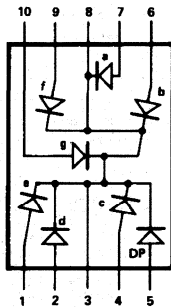

**J**

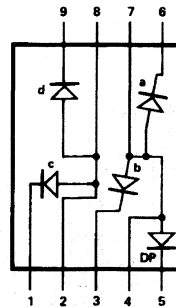

**K**

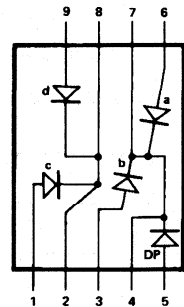

**L**

## Internal Circuit Diagram (HDSP-3900/-4200 Series)

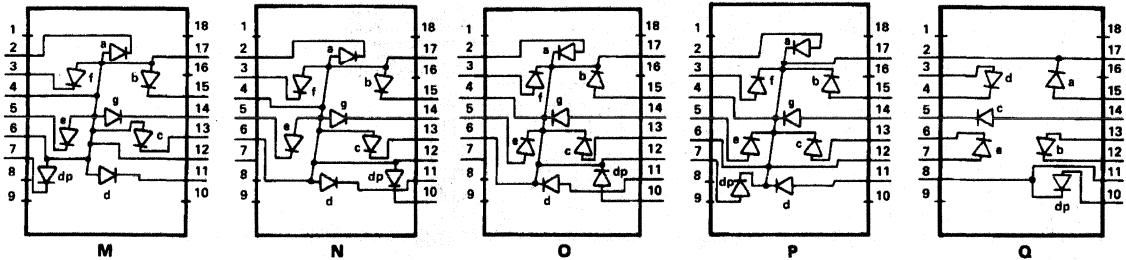

## Electrical/Optical Characteristics at $T_A = 25^\circ\text{C}$

Parameter	Sym.	Device HDSP-	Min.	Typ.	Max.	Units	Test Condition		
Luminous Intensity/ Segment <sup>[9,10]</sup> (Digit Average)	$I_V$	3530	1500	4500		$\mu\text{cd}$	100 mA Pk; 1 of 5 Duty Factor		
		3730	1500	5000					
		5530	2200	7000					
		3900	2200	7000					
				3530		3100		$\mu\text{cd}$	20 mA DC
				3730		3500			
				5530		4800			
				3900		4800			
				4030	1500	4500		$\mu\text{cd}$	100 mA Pk; 1 of 5 Duty Factor
				4130	1500	5000			
				5730	2200	7000			
				4200	2200	7000			
		4030		2200		$\mu\text{cd}$	20 mA DC		
		4130		2500					
		5730		3400					
		4200		3400					
Peak Wavelength	$\lambda_{\text{PEAK}}$	3530/3730/ 5530/3900		635		nm			
		4030/4130/ 5730/4200		583		nm			
Dominant Wavelength <sup>[11,12]</sup> (Digit Average)	$\lambda_d$	3530/3730/ 5530/3900		626		nm			
		4030/4130/ 5730/4200	581.5	586	592.5	nm			
Forward Voltage/Seg or D.P.	$V_F$	All Devices		2.6	3.5	V	$I_F = 100 \text{ mA}$		
Reverse Current/Seg or D.P.	$I_R$	All Devices			100	$\mu\text{A}$	$V_R = 3.0 \text{ V}$		
Temp. Coeff. of $V_F$ /Seg or D.P.	$\Delta V_F/^\circ\text{C}$	All Devices		-1.1		$\text{mV}/^\circ\text{C}$	$I_F = 100 \text{ mA}$		
Thermal Resistance LED Junction-to-Pin	$R\theta_{J-PIN}$	3530/4030/ 3730/4130		282		$^\circ\text{C}/\text{W}/\text{Seg}$			
		5530/5730		345		$^\circ\text{C}/\text{W}/\text{Seg}$			
		3900/4200		375		$^\circ\text{C}/\text{W}/\text{Seg}$			

### Notes:

9. Case temperature of the device immediately prior to the intensity measurement is  $25^\circ\text{C}$ .
10. The digits are categorized for luminous intensity with the intensity category designated by a letter on the side of the package.
11. The dominant wavelength,  $\lambda_d$ , is derived from the CIE chromaticity diagram and is that single wavelength which defines the color of the device.
12. The yellow displays are categorized as to dominant wavelength with the category designated by a number adjacent to the intensity category letter.

SEVEN SEGMENT  
NUMERIC DISPLAYS

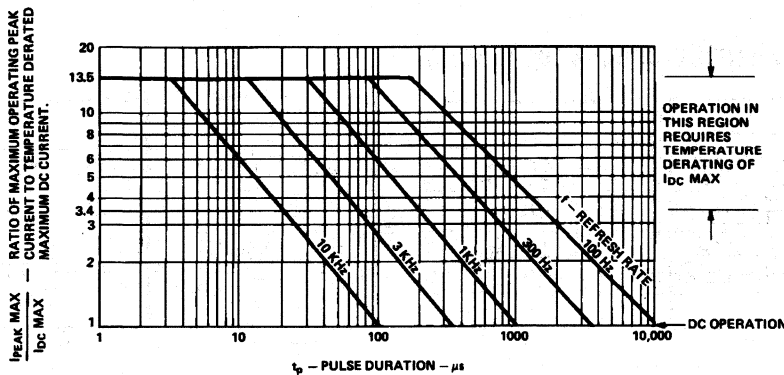

Figure 1. Maximum Allowed Peak Current vs. Pulse Duration.

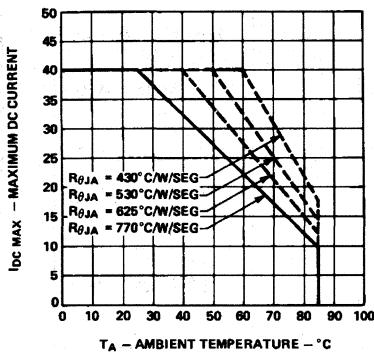

Figure 2. Maximum Allowable DC Current per Segment vs. Ambient Temperature.

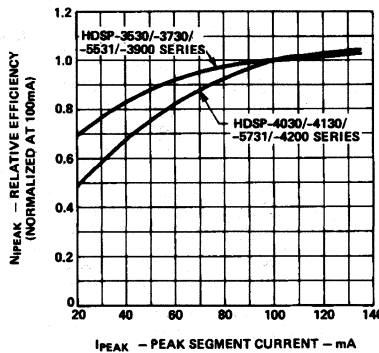

Figure 3. Relative Efficiency (Luminous Intensity per Unit Current) vs. Peak Segment Current.

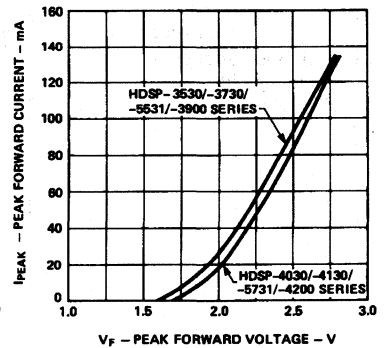

Figure 4. Peak Forward Segment Current vs. Peak Forward Voltage.

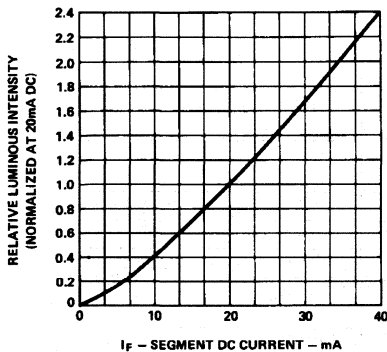

Figure 5. Relative Luminous Intensity vs. DC Forward Current.

## Electrical

These display devices are composed of eight light emitting diodes, with light from each LED optically stretched to form individual segments and a decimal point.

The devices utilize LED chips which are made from GaAsP on a transparent GaP substrate.

These display devices are designed for strobed operation. The typical forward voltage values, scaled from Figure 4, should be used for calculating the current limiting resistor value and typical power dissipation.

Expected maximum  $V_F$  values, for the purpose of driver circuit design and maximum power dissipation, may be calculated using the following  $V_F$  MAX models:

$$V_F \text{ MAX} = 2.15 \text{ V} + I_{\text{PEAK}} (13.5 \Omega)$$

For:  $I_F \geq 30 \text{ mA}$

$$V_F \text{ MAX} = 1.9 \text{ V} + I_{\text{DC}} (21.8 \Omega)$$

For:  $10 \text{ mA} \leq I_F \leq 30 \text{ mA}$

Temperature derated strobed operating conditions are obtained from Figures 1 and 2. Figure 1 relates pulse duration ( $t_p$ ), refresh rate ( $f$ ), and the ratio of maximum peak current to maximum

dc current ( $I_{PEAK\ MAX}/I_{DC\ MAX}$ ). Figure 2 presents the maximum allowed dc current vs. ambient temperature. Figure 1 is based on the principle that the peak junction temperature for pulsed operation at a specified peak current, pulse duration and refresh rate should be the same as the junction temperature at maximum DC operation. Refresh rates of 1 kHz or faster minimize the pulsed junction heating effect of the device resulting in the maximum possible time average luminous intensity.

The time average luminous intensity can be calculated knowing the average forward current and relative efficiency characteristic,  $\eta_{|PEAK}$ , of Figure 3. Time average luminous intensity for a device case temperature of 25°C,  $I_V$  (25°C), is calculated as follows:

$$I_V(25^\circ C) = \left[ \frac{I_{AVG}}{20\text{ mA}} \right] [\eta_{|PEAK}] [I_V\text{ DATA SHEET}]$$

Example: For HDSP-4030 series

$$\eta_{|PEAK} = 1.00 \text{ at } I_{PEAK} = 100\text{ mA. For DF} = 1/5:$$

$$I_V(25^\circ) = \left[ \frac{20\text{ mA}}{20\text{ mA}} \right] [1.00][4.5\text{ mcd}] = 4.5\text{ mcd/segment}$$

The time average luminous intensity may be adjusted for operating junction temperature by the following exponential equation:

$$I_V(T_J) = I_V(25^\circ C) e^{k(T_J + 25^\circ C)}$$

$$\text{where } T_J = T_A + P_D \cdot R\theta_{J-A}$$

Device	K
-3530/-3730/ -5530/-3900	-0.0131/°C
-4030/-4130/ -5730/-4200	-0.0112/°C

### Mechanical

These devices are constructed utilizing a lead frame in a standard DIP package. The LED dice are attached directly to the lead frame. Therefore, the cathode leads are the direct thermal and mechanical stress paths to the LED dice. The absolute maximum allowed junction temperature,  $T_J\ MAX$ , is 105°C. The maximum power ratings have been established so that the worst case  $V_F$  device does not exceed this limit.

Worst case thermal resistance pin-to-ambient is 400°C/W/Seg when these devices are soldered into minimum trace width PC boards. When installed in a PC board that provides  $R\theta_{PIN-A}$  less than 400°C/W/Seg these displays may be operated at higher average currents as shown in Figure 2.

### Optical

The radiation pattern for these devices is approximately Lambertian. The luminous sterance may be calculated using one of the two following formulas.

$$L_V(\text{cd/m}^2) = \frac{I_V(\text{cd})}{A(\text{m}^2)}$$

$$L_V(\text{footlamberts}) = \frac{\pi I_V(\text{cd})}{A(\text{ft}^2)}$$

Device	Area/Seg. mm <sup>2</sup>	Area/Seg. in <sup>2</sup>
-3530/-4030	2.5	0.0039
-3730/-4130	4.4	0.0068
-5530/-5730	8.8	0.0137
-3900/-4200	14.9	0.0231

### Contrast Enhancement

The objective of contrast enhancement is to optimize display readability. Adequate contrast enhancement can be achieved in indoor applications through luminous contrast techniques. Luminous contrast is the observed brightness of the illuminated segment compared to the brightness of the surround. Appropriate wavelength filters maximize luminous contrast by reducing the amount of light reflected from the area around the display while transmitting most of the light emitted by the segment. These filters are described further in Application Note 1015.

Chrominance contrast can further improve display readability. Chrominance contrast refers to the color difference between the illuminated segment and the surrounding area. These displays are assembled with a gray package and untinted encapsulating epoxy in the segments to improve chrominance contrast of the ON segments. Additional contrast enhancement in bright ambients may be achieved by using a neutral density gray filter such as Panelgraphic Chromafilter Gray 10, or 3M Light Control Film (louvered film).

# 7.6 mm (0.3 inch)/10.9 mm (0.43 inch) Seven Segment Displays

## Technical Data

**5082-761X Series**  
**5082-762X Series**  
**5082-765X Series**  
**5082-766X Series**  
**5082-773X Series**  
**5082-7740**  
**5082-775X Series**  
**5082-7760**  
**HDSP-360X Series**  
**HDSP-460X Series**  
**HDSP-E15X Series**

### Features

- **Industry Standard Size**
- **Industry Standard Pinout**  
7.62 mm (0.300 inch) DIP  
Leads on 2.54 mm (0.100 inch) Centers
- **Choice of Colors**  
Red, AlGaAs Red, High Efficiency Red, Yellow, Green
- **Excellent Appearance**  
Evenly Lighted Segments  
Gray Package Gives Optimum Contrast  
± 50° Viewing Angle
- **Design Flexibility**  
Common Anode or Common Cathode  
Single Digits  
Left or Right Hand Decimal Point  
± 1. Overflow Character
- **Categorized for Luminous Intensity**  
Yellow and Green Categorized for Color  
Use of Like Categories Yields a Uniform Display
- **High Light Output**
- **High Peak Current**
- **Excellent for Long Digit String Multiplexing**
- **Intensity and Color Selection Available**  
See Intensity and Color Selected Displays Data Sheet
- **Sunlight Viewable AlGaAs**

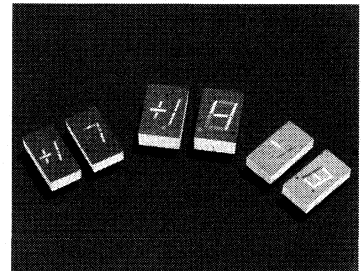

segment displays are designed for viewing distances up to 3 metres (10 feet) and 5 metres (16 feet). These devices use an industry standard size package and pinouts. All devices are available as either common anode or common cathode.

### Description

The 7.6 mm (0.3 inch) and 10.9 mm (0.43 inch) LED seven

### Devices

Red 5082-	AlGaAs <sup>(1)</sup> Red HDSP-	HER <sup>(1)</sup> 5082-	Yellow 5082-	Green HDSP-	Description	Package Drawing
7730		7610	7620	3600	7.6 mm Common Anode Left Hand Decimal	A
7731		7611	7621	3601	7.6 mm Common Anode Right Hand Decimal	B
7740		7613	7623	3603	7.6 mm Common Cathode Right Hand Decimal	C
7736		7616	7626	3606	7.6 mm Universal ± 1. Overflow Right Hand Decimal <sup>(2)</sup>	D
7750	E150	7650	7660	4600	10.9 mm Common Anode Left Hand Decimal	E
7751	E151	7651	7661	4601	10.9 mm Common Anode Right Hand Decimal	F
7760	E153	7653	7663	4603	10.9 mm Common Cathode Right Hand Decimal	G
7756	E156	7656	7666	4606	10.9 mm Universal ± 1. Overflow Right Hand Decimal <sup>(2)</sup>	H

#### Notes:

1. These displays are recommended for high ambient light operation. Please refer to the HDSP-E10X AlGaAs and HDSP-335X HER data sheet for low current operation.
2. Universal pinout brings the anode and cathode of each segment's LED out to separate pins. See internal diagram D.
3. Universal pinout brings the anode and cathode of each segment's LED out to separate pins. See internal diagram H.

These displays are ideal for most applications. Pin for pin equivalent displays are also available in a low current or high light

ambient design. The low current displays are ideal for portable applications. The high light ambient displays are ideal for high light ambients or long string

lengths. For additional information see the Low Current Seven Segment Displays, or High Light Ambient Seven Segment Displays data sheets.

### Package Dimensions

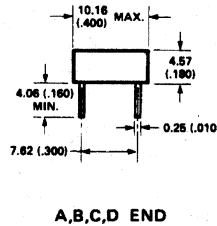
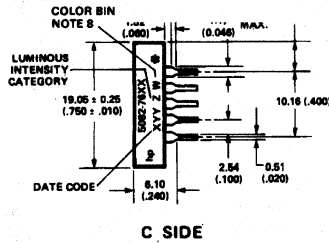
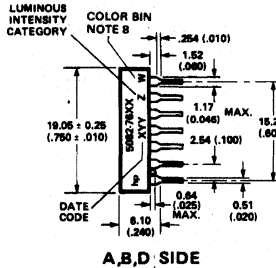
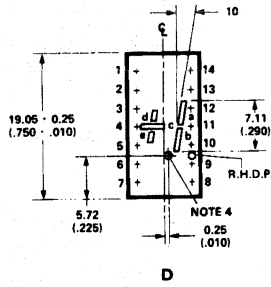
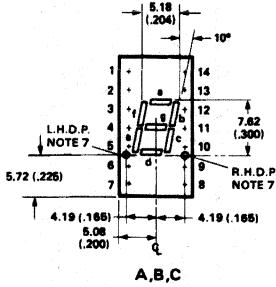

- NOTES:
- DIMENSIONS IN MILLIMETRES AND (INCHES).
  - ALL UNTOLERANCED DIMENSIONS ARE FOR REFERENCE ONLY.
  - REDUNDANT ANODES.
  - UNUSED DP POSITION.
  - SEE INTERNAL CIRCUIT DIAGRAM.
  - REDUNDANT CATHODE.
  - SEE PART NUMBER TABLE FOR L.H.D.P. AND R.H.D.P. DESIGNATION.
  - FOR YELLOW AND GREEN DEVICES ONLY.

\*The Side View of package Indicates Country of Origin.

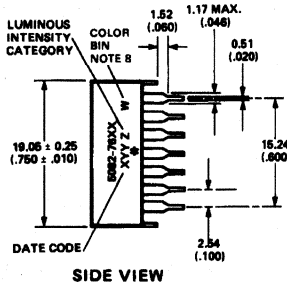
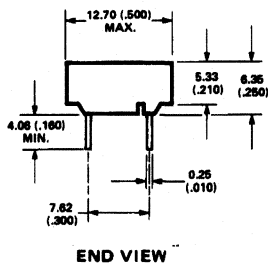
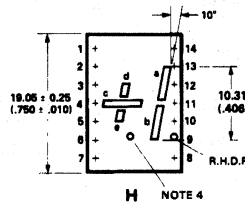
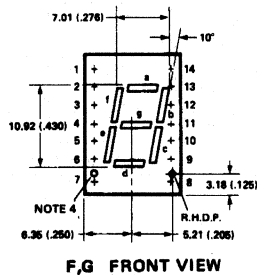
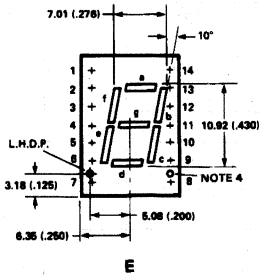

\*The Side View of package Indicates Country of Origin.

PIN	FUNCTION			
	A	B	C	D
1	CATHODE-a	CATHODE-a	NO PIN	ANODE-d
2	CATHODE-f	CATHODE-f	CATHODE <sup>(1)</sup>	NO PIN
3	ANODE <sup>(2)</sup>	ANODE <sup>(2)</sup>	ANODE-f	CATHODE-d
4	NO PIN	NO PIN	ANODE-g	CATHODE-c
5	NO PIN	NO PIN	ANODE-e	CATHODE-e
6	CATHODE-dp	NO CONN. <sup>(3)</sup>	ANODE-d	ANODE-e
7	CATHODE-e	CATHODE-e	NO PIN	ANODE-c
8	CATHODE-d	CATHODE-d	NO PIN	ANODE-dp
9	NO CONN. <sup>(3)</sup>	CATHODE-dp	CATHODE <sup>(1)</sup>	NO PIN
10	CATHODE-c	CATHODE-c	ANODE-dp	CATHODE-dp
11	CATHODE-g	CATHODE-g	ANODE-c	CATHODE-b
12	NO PIN	NO PIN	ANODE-b	CATHODE-a
13	CATHODE-b	CATHODE-b	ANODE-a	ANODE-a
14	ANODE <sup>(2)</sup>	ANODE <sup>(2)</sup>	NO PIN	ANODE-b

PIN	FUNCTION			
	E	F	G	H
1	CATHODE-a	CATHODE-a	ANODE-a	CATHODE-d
2	CATHODE-f	CATHODE-f	ANODE-f	ANODE-d
3	ANODE <sup>(2)</sup>	ANODE <sup>(2)</sup>	CATHODE <sup>(1)</sup>	NO PIN
4	NO PIN	NO PIN	NO PIN	CATHODE-c
5	NO PIN	NO PIN	NO PIN	CATHODE-e
6	CATHODE-dp	NO CONN. <sup>(3)</sup>	NO CONN. <sup>(3)</sup>	ANODE-e
7	CATHODE-e	CATHODE-e	ANODE-e	ANODE-c
8	CATHODE-d	CATHODE-d	ANODE-d	ANODE-dp
9	NO CONN. <sup>(3)</sup>	CATHODE-dp	ANODE-dp	CATHODE-dp
10	CATHODE-c	CATHODE-c	ANODE-c	CATHODE-b
11	CATHODE-g	CATHODE-g	ANODE-g	CATHODE-a
12	NO PIN	NO PIN	NO PIN	NO PIN
13	CATHODE-b	CATHODE-b	ANODE-b	ANODE-a
14	ANODE <sup>(2)</sup>	ANODE <sup>(2)</sup>	CATHODE <sup>(1)</sup>	ANODE-b

SEVEN SEGMENT  
NUMERIC DISPLAYS

## Internal Circuit Diagram

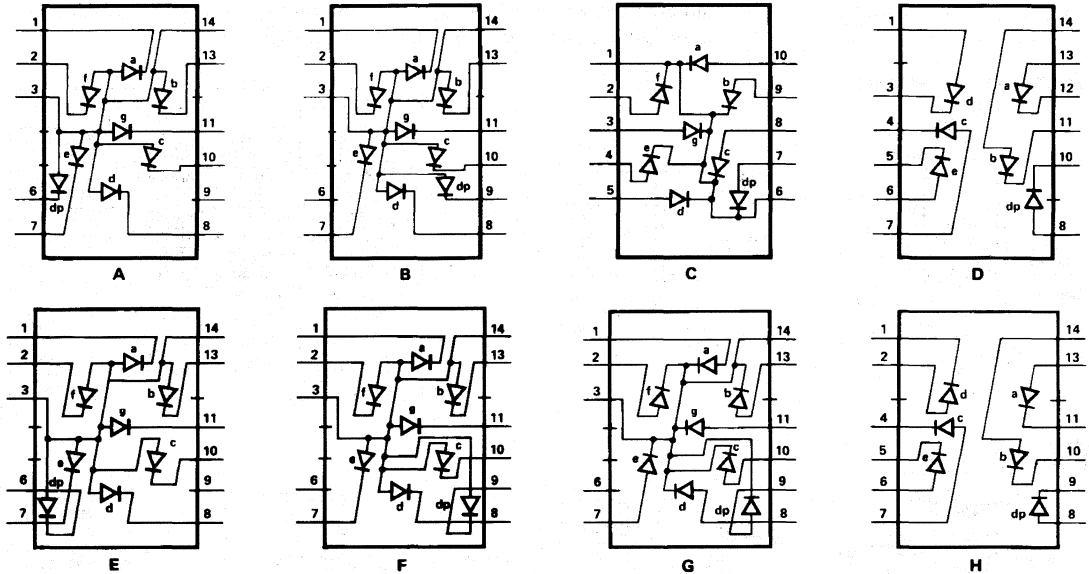

## Absolute Maximum Ratings

Description	Red 5082-7700 Series	AlGaAs Red HDSP-E150 Series	HER 5082-7610/ 7650 Series	Yellow 5082-7620/ 7660 Series	Green HDSP-3600/ 4600 Series	Units
Average Power per Segment or DP	82	96	105	80	105	mW
Peak Forward Current per Segment or DP	150 <sup>[1]</sup>	160 <sup>[3]</sup>	90 <sup>[5]</sup>	60 <sup>[7]</sup>	90 <sup>[9]</sup>	mA
DC Forward Current per Segment or DP	25 <sup>[2]</sup>	40 <sup>[4]</sup>	30 <sup>[6]</sup>	20 <sup>[8]</sup>	30 <sup>[10]</sup>	mA
Operating Temperature Range	-40 to +100	-20 to +100 <sup>[11]</sup>	-40 to +100			°C
Storage Temperature Range	-55 to +100					°C
Reverse Voltage per Segment or DP	3.0					V
Lead Solder Temperature for 3 Seconds (1.59 mm [0.063 in.] below seating plane)	260					°C

### Notes:

- See Figure 1 to establish pulsed conditions.
- Derate above 80°C at 0.63 mA/°C.
- See Figure 2 to establish pulsed conditions.
- Derate above 46°C at 0.54 mA/°C.
- See Figure 7 to establish pulsed conditions.
- Derate above 53°C at 0.45 mA/°C.
- See Figure 8 to establish pulsed conditions.
- Derate above 81°C at 0.52 mA/°C.
- See Figure 9 to establish pulsed conditions.
- Derate above 39°C at 0.37 mA/°C.
- For operation below -20°C, contact your local HP components sales office or an authorized distributor.



## Electrical/Optical Characteristics at T<sub>A</sub> = 25°C

### Red

Device Series	Parameter	Symbol	Min.	Typ.	Max.	Units	Test Conditions
5082-773X 5082-774X	Luminous Intensity/Segment <sup>[1,2]</sup> (Digit Average)	I <sub>V</sub>	360	770		μcd	I <sub>F</sub> = 20 mA
5082-775X 5082-776X			360	1100		μcd	I <sub>F</sub> = 20 mA
All	Forward Voltage/Segment or DP	V <sub>F</sub>		1.6	2.0	V	I <sub>F</sub> = 20 mA
	Peak Wavelength	λ <sub>PEAK</sub>		655		nm	
	Dominant Wavelength <sup>[3]</sup>	λ <sub>d</sub>		640		nm	
	Reverse Voltage/Segment or DP <sup>[4]</sup>	V <sub>R</sub>	3.0	12		V	I <sub>R</sub> = 100 μA
	Temperature Coefficient of V <sub>F</sub> /Segment or DP	ΔV <sub>F</sub> /°C		-2		mV/°C	
	Thermal Resistance LED Junction-to-Pin	Rθ <sub>J-PIN</sub>		280		°C/W/Seg	

### AlGaAs Red

Device Series	Parameter	Symbol	Min.	Typ.	Max.	Units	Test Conditions
HDSP-E15X	Luminous Intensity/Segment <sup>[1,2,5]</sup> (Digit Average)	I <sub>V</sub>	8.5	15.0		mcd	I <sub>F</sub> = 20 mA
	Forward Voltage/Segment or DP	V <sub>F</sub>		1.8		V	I <sub>F</sub> = 20 mA
				2.0	3.0	V	I <sub>F</sub> = 100 mA
	Peak Wavelength	λ <sub>PEAK</sub>		645		nm	
	Dominant Wavelength <sup>[3]</sup>	λ <sub>d</sub>		637		nm	
	Reverse Voltage/Segment or DP <sup>[4]</sup>	V <sub>R</sub>	3.0	15		V	I <sub>R</sub> = 100 μA
	Temperature Coefficient of V <sub>F</sub> /Segment or DP	ΔV <sub>F</sub> /°C		-2		mV/°C	
Thermal Resistance LED Junction-to-Pin	Rθ <sub>J-PIN</sub>		340		°C/W/Seg		

### High Efficiency Red

Device Series	Parameter	Symbol	Min.	Typ.	Max.	Units	Test Conditions
5082-761X	Luminous Intensity/Segment <sup>[1,2,6]</sup> (Digit Average)	$I_V$	340	800		$\mu\text{cd}$	$I_F = 5 \text{ mA}$
5082-765X			340	1115		$\mu\text{cd}$	$I_F = 5 \text{ mA}$
All	Forward Voltage/Segment or DP	$V_F$		2.1	2.5	V	$I_F = 20 \text{ mA}$
	Peak Wavelength	$\lambda_{\text{PEAK}}$		635		nm	
	Dominant Wavelength <sup>[3]</sup>	$\lambda_d$		626		nm	
	Reverse Voltage/Segment or DP <sup>[4]</sup>	$V_R$	3.0	30		V	$I_R = 100 \mu\text{A}$
	Temperature Coefficient of $V_F$ /Segment or DP	$\Delta V_F / ^\circ\text{C}$		-2		mV/ $^\circ\text{C}$	
	Thermal Resistance LED Junction-to-Pin	$R\theta_{\text{J-PIN}}$		280		$^\circ\text{C/W}$	

### Yellow

Device Series	Parameter	Symbol	Min.	Typ.	Max.	Units	Test Conditions
5082-762X	Luminous Intensity/Segment <sup>[1,2]</sup> (Digit Average)	$I_V$	205	620		$\mu\text{cd}$	$I_F = 5 \text{ mA}$
5082-766X			290	835		$\mu\text{cd}$	$I_F = 5 \text{ mA}$
All	Forward Voltage/Segment or DP	$V_F$		2.2	2.5	V	$I_F = 20 \text{ mA}$
	Peak Wavelength	$\lambda_{\text{PEAK}}$		583		nm	
	Dominant Wavelength <sup>[3,7]</sup>	$\lambda_d$	581.5	586	592.5	nm	
	Reverse Voltage/Segment or DP <sup>[4]</sup>	$V_R$	3.0	40		V	$I_R = 100 \mu\text{A}$
	Temperature Coefficient of $V_F$ /Segment or DP	$\Delta V_F / ^\circ\text{C}$		-2		mV/ $^\circ\text{C}$	
	Thermal Resistance LED Junction-to-Pin	$R\theta_{\text{J-PIN}}$		280		$^\circ\text{C/W/Seg}$	

### High Performance Green

Device Series	Parameter	Symbol	Min.	Typ.	Max.	Units	Test Conditions
HDSP-360X	Luminous Intensity/Segment <sup>[1,2]</sup> (Digit Average)	$I_V$	860	2700		$\mu\text{cd}$	$I_F = 10 \text{ mA}$
HDSP-460X			1030	4000		$\mu\text{cd}$	$I_F = 10 \text{ mA}$
All	Forward Voltage/Segment or DP	$V_F$		2.1	2.5	V	$I_F = 10 \text{ mA}$
	Peak Wavelength	$\lambda_{\text{PEAK}}$		566		nm	
	Dominant Wavelength <sup>[3,7]</sup>	$\lambda_d$		571	577	nm	
	Reverse Voltage/Segment or DP <sup>[4]</sup>	$V_R$	3.0	50		V	$I_R = 100 \mu\text{A}$
	Temperature Coefficient of $V_F$ /Segment or DP	$\Delta V_F / ^\circ\text{C}$		-2		mV/ $^\circ\text{C}$	
	Thermal Resistance LED Junction-to-Pin	$R\theta_{\text{J-PIN}}$		280		$^\circ\text{C/W/Seg}$	

**Notes:**

1. Device case temperature is 25°C prior to the intensity measurement.
2. The digits are categorized for luminous intensity. The intensity category is designated by a letter on the side of the package.
3. The dominant wavelength,  $\lambda_d$ , is derived from the CIE chromaticity diagram and is that single wavelength which defines the color of the device.
4. Typical specification for reference only. Do not exceed absolute maximum ratings.
5. For low current operation, the AlGaAs HDSP-E10X series displays are recommended. They are tested at 1 mA dc/segment and are pin for pin compatible with the HDSP-E15X series.
6. For low current operation, the HER HDSP-335X series displays are recommended. They are tested at 2 mA dc/segment and are pin for pin compatible with the 5082-7650 series.
7. The Yellow (5082-7620/7660) and Green (HDSP-3600/4600) displays are categorized for dominant wavelength. The category is designated by a number adjacent to the luminous intensity category letter.

### Red, AlGaAs Red

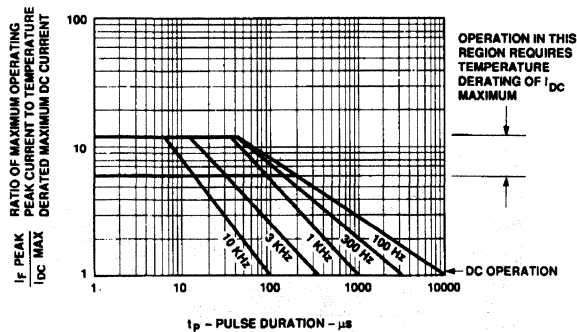

Figure 1. Maximum Tolerable Peak Current vs. Pulse Duration - Red.

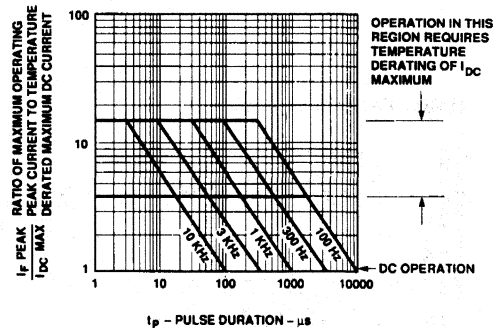

Figure 2. Maximum Allowed Peak Current vs. Pulse Duration - AlGaAs Red.

### Red, AlGaAs Red (Continued)

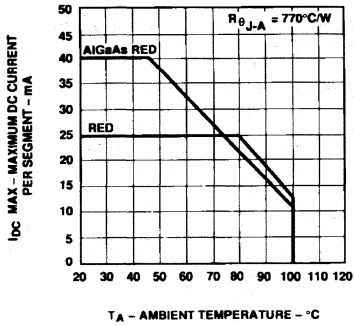

Figure 3. Maximum Allowable DC Current vs. Ambient Temperature.

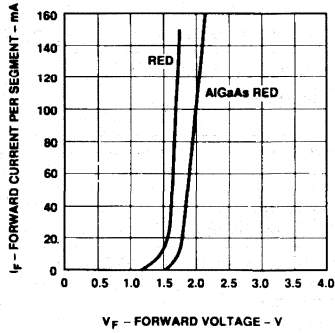

Figure 4. Forward Current vs. Forward Voltage.

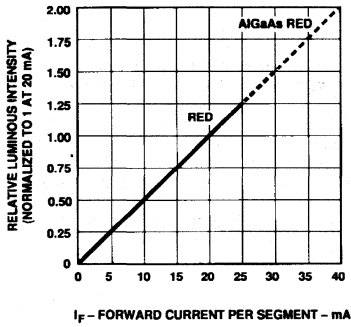

Figure 5. Relative Luminous Intensity vs. DC Forward Current.

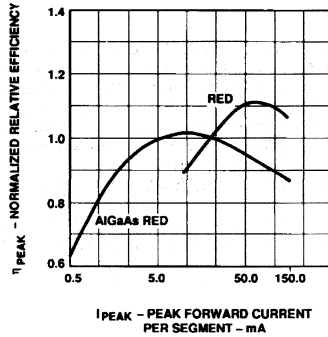

Figure 6. Relative Efficiency (Luminous Intensity per Unit Current) vs. Peak Current.

### HER, Yellow, Green

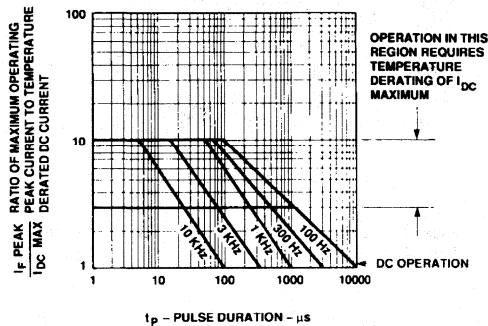

Figure 7. Maximum Tolerable Peak Current vs. Pulse Duration - HER Series.

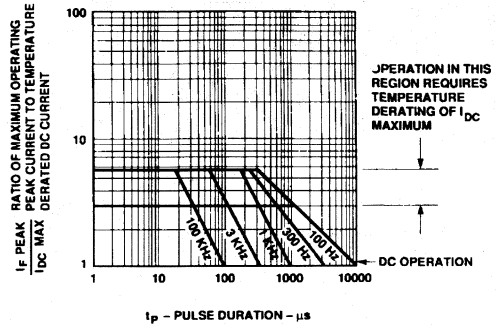

Figure 8. Maximum Tolerable Peak Current vs. Pulse Duration - Yellow Series.

## HER, Yellow, Green (Continued)

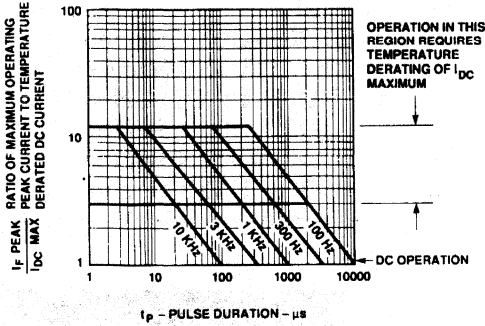

Figure 9. Allowable Peak Current vs. Pulse Duration - Green Series.

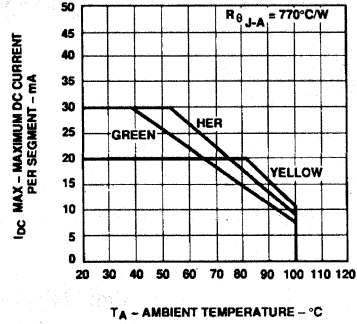

Figure 10. Maximum Allowable DC Current vs. Ambient Temperature.

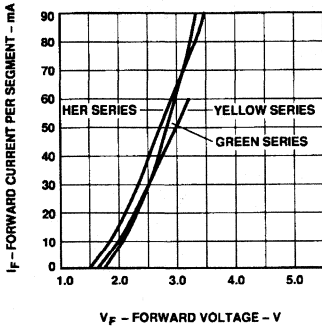

Figure 11. Forward Current vs. Forward Voltage.

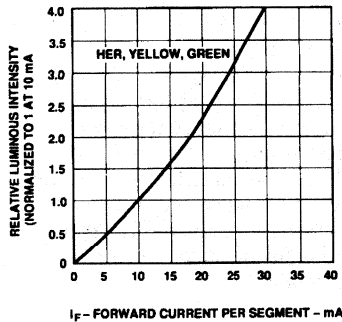

Figure 12. Relative Luminous Intensity vs. DC Forward Current.

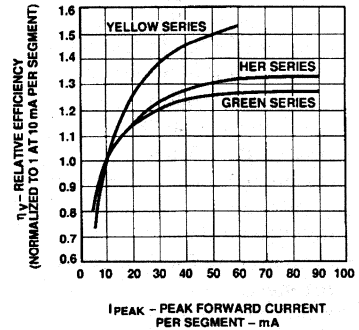

Figure 13. Relative Luminous Efficiency (Luminous Intensity per Unit Current) vs. Peak Current.

## Contrast Enhancement

For information on contrast enhancement please see Application Note 1015.

## Soldering/Cleaning

For information on soldering LEDs please refer to Application Note 1027.

# 8 mm (0.31 inch) Ultra Mini Seven Segment Displays

## Technical Data

**HDSP-U0XX Series**  
**HDSP-U1XX Series**  
**HDSP-U2XX Series**  
**HDSP-U3XX Series**  
**HDSP-U4XX Series**  
**HDSP-U5XX Series**

### Features

- **Compact Package**
- **8 mm (0.31 inch) Character Height**
- **Choice of Colors**  
Wide Range of Colors
- **Excellent Appearance**  
Evenly Lighted Segments  
Mitered Corners on Segments  
Gray/Black Surface Gives  
Optimum Contrast  
± 50° Viewing Angle
- **Design Flexibility**  
Common Anode or Common  
Cathode  
Right Hand Decimal Point
- **Categorized for Luminous Intensity**  
Yellow and Green also  
Categorized for Color  
Use of Like Categories Yields  
a Uniform Display

- **High Light Output**
- **High Peak Current**
- **Excellent for Long Digit String Multiplexing**
- **Intensity and Color Selection Option**

### Description

The 8 mm (0.31 inch) LED seven segment displays are HP's most space-efficient character size. They are designed for viewing distances up to 3 metres (10 feet). The numeric devices feature a right hand decimal point. All devices are available as either common anode or common cathode.

Typical applications include appliances, temperature controllers, and digital panel meters.

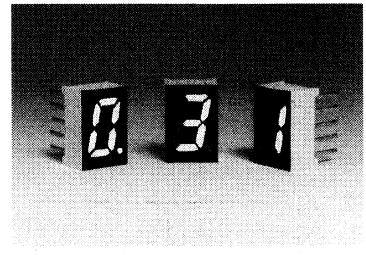

### Devices

Red HDSP-	AlGaAs Red HDSP-	HER HDSP-	Orange HDSP-	Yellow HDSP-	Green HDSP-	Description	Circuit Diagram
U001	U101	U201	U401	U301	U501	Common Anode, Right Hand Decimal, Gray Surface	A
U003	U103	U203	U403	U303	U503	Common Cathode, Right Hand Decimal, Gray Surface	B
U011	U111	U211	U411	U311	U511	Common Anode, Right Hand Decimal, Black Surface	A
U013	U113	U213	U413	U313	U513	Common Cathode, Right Hand Decimal, Black Surface	B

## Package Dimensions

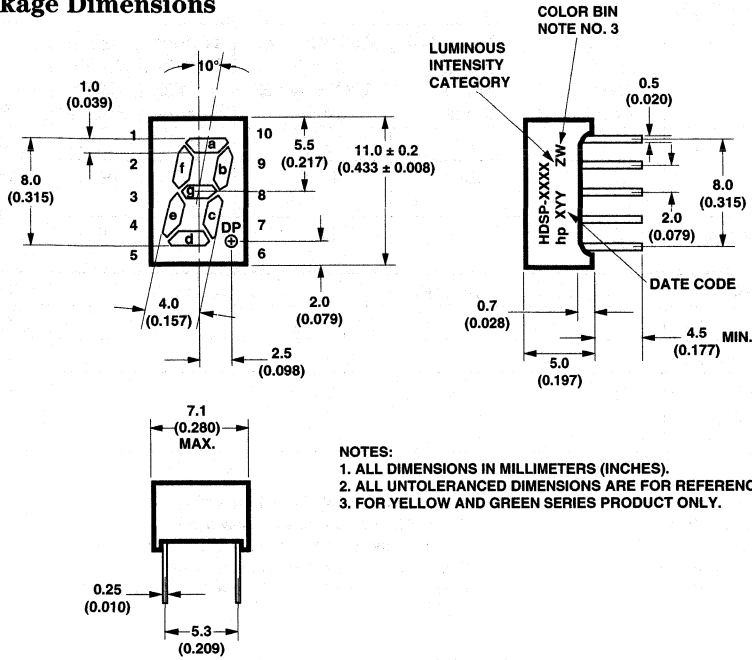

### NOTES:

1. ALL DIMENSIONS IN MILLIMETERS (INCHES).
2. ALL UNTOLERANCED DIMENSIONS ARE FOR REFERENCE ONLY.
3. FOR YELLOW AND GREEN SERIES PRODUCT ONLY.

SEVEN SEGMENT  
NUMERIC DISPLAYS

## Internal Circuit Diagram

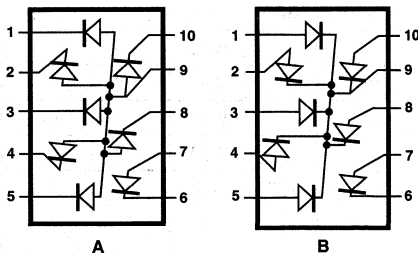

PIN	FUNCTION	
	A	B
1	CATHODE a	ANODE a
2	CATHODE f	ANODE f
3	CATHODE g	ANODE g
4	CATHODE e	ANODE e
5	CATHODE d	ANODE d
6	CATHODE DP	CATHODE DP
7	ANODE DP	ANODE DP
8	CATHODE c	ANODE c
9	ANODE	CATHODE
10	CATHODE b	ANODE b

HDSP-UXXX CIRCUIT

## Absolute Maximum Ratings

Description	Red HDSP-U0XX Series	AlGaAs Red HDSP-U1XX Series	HER/Orange HDSP-U2XX/-4XX Series	Yellow HDSP-U3XX Series	Green HDSP-U5XX Series	Units
Average Power per Segment or DP	82	37	105	80	105	mW
Peak Forward Current per Segment or DP	150 <sup>[1]</sup>	45 <sup>[3]</sup>	90 <sup>[5]</sup>	60 <sup>[7]</sup>	90 <sup>[9]</sup>	mA
DC Forward Current per Segment or DP	25 <sup>[2]</sup>	15 <sup>[4]</sup>	30 <sup>[6]</sup>	20 <sup>[8]</sup>	30 <sup>[10]</sup>	mA
Operating Temperature Range	-25 to +90	-20 to +90	-25 to +90			°C
Storage Temperature Range	-30 – +90					°C
Reverse Voltage per Segment or DP	3.0					V
Lead Solder Temperature for 3 Seconds (1.60 mm [0.063 in.] below seating plane)	260					°C

### Notes:

1. See Figure 1 to establish pulsed conditions.
2. Derate above 80°C at 0.63 mA/°C (see figure 3).
3. See Figure 2 to establish pulsed conditions.
4. No derating over specified temperature range.
5. See Figure 7 to establish pulsed conditions.
6. Derate above 53°C at 0.45 mA/°C (see figure 10).
7. See Figure 8 to establish pulsed conditions.
8. Derate above 81°C at 0.52 mA/°C (see figure 10).
9. See Figure 9 to establish pulsed conditions.
10. Derate above 39°C at 0.37 mA/°C (see figure 10).

## Electrical/Optical Characteristics at T<sub>A</sub> = 25°C

### Red

Device Series	Parameter	Symbol	Min.	Typ.	Max.	Units	Test Conditions
HDSP-U0XX	Luminous Intensity/Segment <sup>[1,2]</sup> (Digit Average)	I <sub>V</sub>	600	1100		μcd	I <sub>F</sub> = 20 mA
				500			I <sub>F</sub> = 10 mA
	Forward Voltage/Segment or DP	V <sub>F</sub>		1.6	2.0	V	I <sub>F</sub> = 20 mA
	Peak Wavelength	λ <sub>PEAK</sub>		655		nm	
	Dominant Wavelength <sup>[3]</sup>	λ <sub>d</sub>		640		nm	
	Reverse Voltage/Segment or DP <sup>[4]</sup>	V <sub>R</sub>	3.0	12		V	I <sub>R</sub> = 100 μA
	Temperature Coefficient of V <sub>F</sub> /Segment or DP	ΔV <sub>F</sub> /°C		-2		mV/°C	
	Thermal Resistance LED Junction-to-Pin	Rθ <sub>J-Pin</sub>		200		°C/W/ Seg	



**AlGaAs Red**

Device Series	Parameter	Symbol	Min.	Typ.	Max.	Units	Test Conditions	
HDSP-U1XX	Luminous Intensity/Segment <sup>[1,2]</sup> (Digit Average)	$I_V$	315	600		$\mu\text{cd}$	$I_F = 1 \text{ mA}$	
				3600			$I_F = 5 \text{ mA}$	
	Forward Voltage/Segment or DP	$V_F$			1.6	2.2	V	$I_F = 1 \text{ mA}$
					1.7			$I_F = 5 \text{ mA}$
					1.8			$I_F = 20 \text{ mA}$
	Peak Wavelength	$\lambda_{\text{PEAK}}$		645		nm		
	Dominant Wavelength <sup>[3]</sup>	$\lambda_d$		637		nm		
	Reverse Voltage/Segment or DP <sup>[4]</sup>	$V_R$	3.0	15		V	$I_R = 100 \mu\text{A}$	
Temperature Coefficient of $V_F$ /Segment or DP	$\Delta V_F/^\circ\text{C}$		-2		mV/°C			
Thermal Resistance LED Junction-to-Pin	$R\theta_{\text{J-Pin}}$		255		°C/W/Seg			

**High Efficiency Red**

Device Series	Parameter	Symbol	Min.	Typ.	Max.	Units	Test Conditions
HDSP-U2XX	Luminous Intensity/Segment <sup>[1,2]</sup> (Digit Average)	$I_V$	360	980		$\mu\text{cd}$	$I_F = 5 \text{ mA}$
				5390			$I_F = 20 \text{ mA}$
	Forward Voltage/Segment or DP	$V_F$		2.0	2.5	V	$I_F = 20 \text{ mA}$
	Peak Wavelength	$\lambda_{\text{PEAK}}$		635		nm	
	Dominant Wavelength <sup>[3]</sup>	$\lambda_d$		626		nm	
	Reverse Voltage/Segment or DP <sup>[4]</sup>	$V_R$	3.0	30		V	$I_R = 100 \mu\text{A}$
	Temperature Coefficient of $V_F$ /Segment or DP	$\Delta V_F/^\circ\text{C}$		-2		mV/°C	
Thermal Resistance LED Junction-to-Pin	$R\theta_{\text{J-Pin}}$		200		°C/W/Seg		

### Orange

Device Series	Parameter	Symbol	Min.	Typ.	Max.	Units	Test Conditions
HDSP-U4XX	Luminous Intensity/Segment <sup>[1,2]</sup> (Digit Average)	I <sub>V</sub>	360	980		μcd	I <sub>F</sub> = 5 mA
				5390			I <sub>F</sub> = 20 mA
	Forward Voltage/Segment or DP	V <sub>F</sub>		2.0	2.5	V	I <sub>F</sub> = 20 mA
	Peak Wavelength	λ <sub>PEAK</sub>		600		nm	
	Dominant Wavelength <sup>[3]</sup>	λ <sub>d</sub>		603		nm	
	Reverse Voltage/Segment or DP <sup>[4]</sup>	V <sub>R</sub>	3.0	30		V	I <sub>R</sub> = 100 μA
	Temperature Coefficient of V <sub>F</sub> /Segment or DP	ΔV <sub>F</sub> /°C		-2		mV/°C	
	Thermal Resistance LED Junction-to-Pin	Rθ <sub>J-Pin</sub>		200		°C/W/Seg	

### Yellow

Device Series	Parameter	Symbol	Min.	Typ.	Max.	Units	Test Conditions
HDSP-U3XX	Luminous Intensity/Segment <sup>[1,2]</sup> (Digit Average)	I <sub>V</sub>	225	480		μcd	I <sub>F</sub> = 5 mA
				2740			I <sub>F</sub> = 20 mA
	Forward Voltage/Segment or DP	V <sub>F</sub>		2.2	2.5	V	I <sub>F</sub> = 20 mA
	Peak Wavelength	λ <sub>PEAK</sub>		583		nm	
	Dominant Wavelength <sup>[3,5]</sup>	λ <sub>d</sub>	581.5	586	592.5	nm	
	Reverse Voltage/Segment or DP <sup>[4]</sup>	V <sub>R</sub>	3.0	50.0		V	I <sub>R</sub> = 100 μA
	Temperature Coefficient of V <sub>F</sub> /Segment or DP	ΔV <sub>F</sub> /°C		-2		mV/°C	
	Thermal Resistance LED Junction-to-Pin	Rθ <sub>J-Pin</sub>		200		°C/W/Seg	

### High Performance Green

Device Series	Parameter	Symbol	Min.	Typ.	Max.	Units	Test Conditions
HDSP-U5XX	Luminous Intensity/Segment <sup>[1,2]</sup> (Digit Average)	I <sub>V</sub>	860	3000		μcd	I <sub>F</sub> = 10 mA
				6800			I <sub>F</sub> = 20 mA
	Forward Voltage/Segment or DP	V <sub>F</sub>		2.1	2.5	V	I <sub>F</sub> = 10 mA
	Peak Wavelength	λ <sub>PEAK</sub>		566		nm	
	Dominant Wavelength <sup>[3,5]</sup>	λ <sub>d</sub>		571		nm	
	Reverse Voltage/Segment or DP <sup>[4]</sup>	V <sub>R</sub>	3.0	50.0		V	I <sub>R</sub> = 100 μA
	Temperature Coefficient of V <sub>F</sub> /Segment or DP	ΔV <sub>F</sub> /°C		-2		mV/°C	
	Thermal Resistance LED Junction-to-Pin	Rθ <sub>J-Pin</sub>		200		°C/W/Seg	

#### Notes:

1. Case temperature of device immediately prior to the intensity measurement is 25°C.
2. The digits are categorized for luminous intensity. The intensity category is designated by a letter on the side of the package.
3. The dominant wavelength, λ<sub>d</sub>, is derived from the CIE chromaticity diagram and is that single wavelength which defines the color of the device.
4. Typical specification for reference only. Do not exceed absolute maximum ratings.
5. The Yellow (HDSP-U3XX) series and Green (HDSP-U5XX) series displays are categorized for dominant wavelength. The category is designated by a number adjacent to the luminous intensity category letter.

## Red, AlGaAs Red

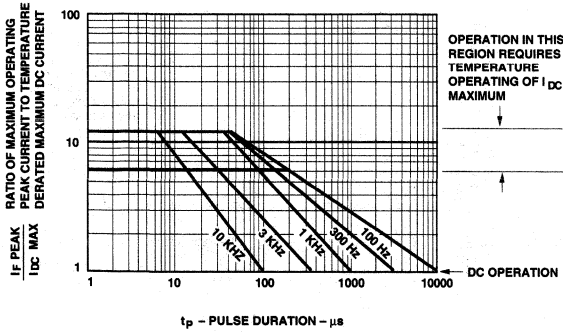

Figure 1. Maximum Tolerable Peak Current vs. Pulse Duration - Red.

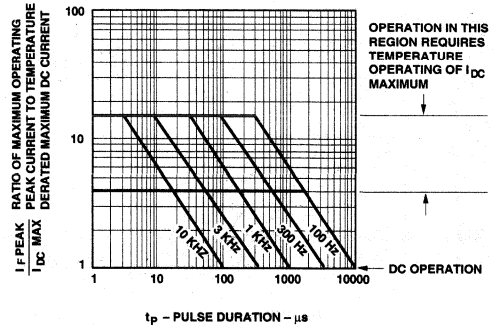

Figure 2. Maximum Tolerable Peak Current vs. Pulse Duration - AlGaAs Red.

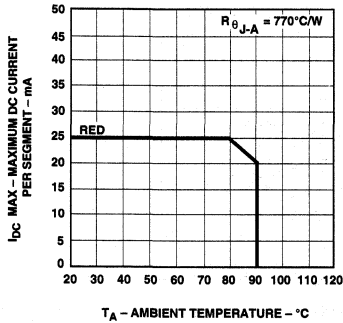

Figure 3. Maximum Allowable DC Current vs. Ambient Temperature.

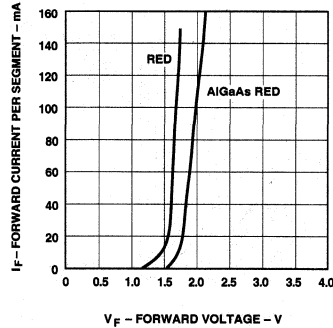

Figure 4. Forward Current vs. Forward Voltage.

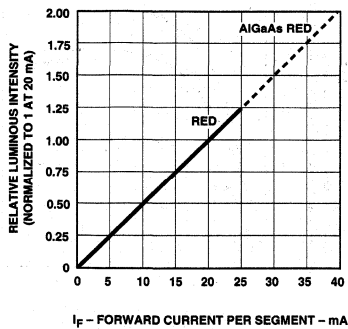

Figure 5. Relative Luminous Intensity vs. DC Forward Current.

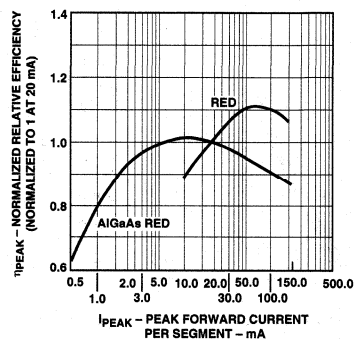

Figure 6. Relative Efficiency (Luminous Intensity per Unit Current) vs. Peak Current.

# HER, Orange, Yellow, Green

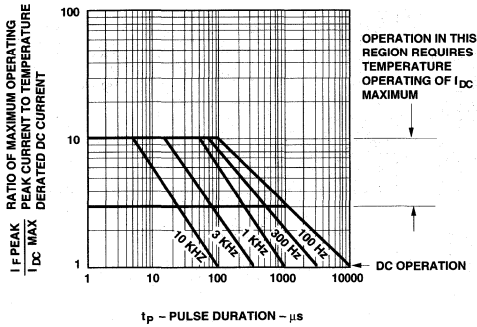

Figure 7. Maximum Tolerable Peak Current vs. Pulse Duration - HER, Orange.

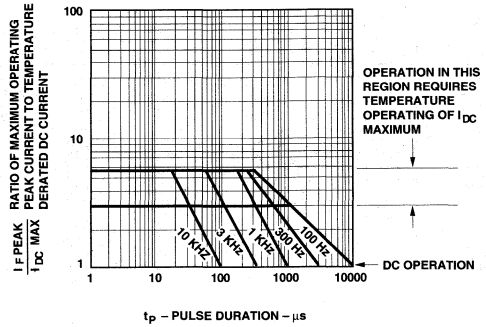

Figure 8. Maximum Tolerable Peak Current vs. Pulse Duration - Yellow.

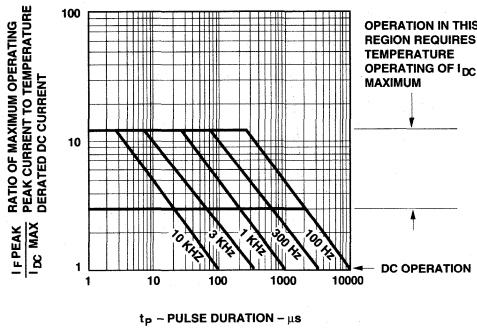

Figure 9. Maximum Tolerable Peak Current vs. Pulse Duration - Green.

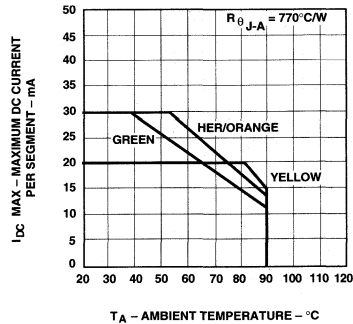

Figure 10. Maximum Allowable DC Current vs. Ambient Temperature.

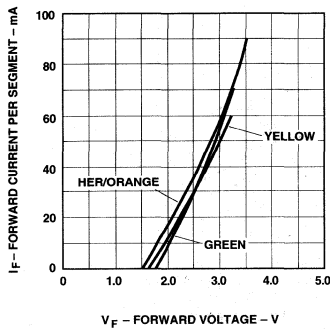

Figure 11. Forward Current vs. Forward Voltage Characteristics.

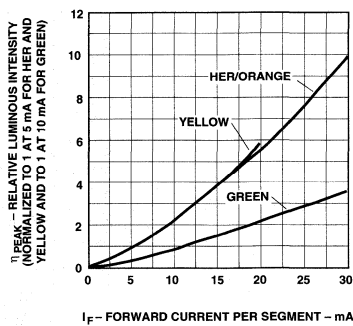

Figure 12. Relative Luminous Intensity vs. DC Forward Current.

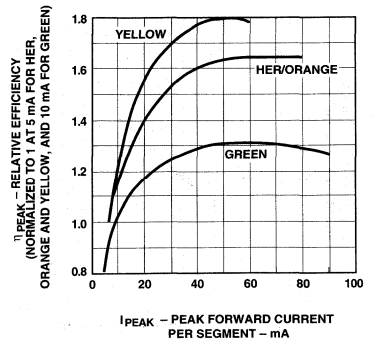

Figure 13. Relative Efficiency (Luminous Intensity per Unit Current) vs. Peak Current.

### **Electrical/Optical**

For more information on electrical/optical characteristics, please see Application Note 1005.

### **Contrast Enhancement**

For information on contrast enhancement please see Application Note 1015.

### **Soldering/Cleaning**

Cleaning agents from the ketone family (acetone, methyl ethyl ketone, etc.) and from the chlorinated hydrocarbon family

(methylene chloride, trichloroethylene, carbon tetrachloride, etc.) are not recommended for cleaning LED parts. All of these various solvents attack or dissolve the encapsulating materials used to form the package of plastic LED parts.

For more information on soldering LEDs please refer to Application Note 1027.

# 7.6 mm (0.3 inch) Micro Bright Seven Segment Displays

## Technical Data

**HDSP-730X Series**  
**HDSP-731X Series**  
**HDSP-740X Series**  
**HDSP-750X Series**  
**HDSP-780X Series**  
**HDSP-A15X Series**

### Features

- **Available with Colon for Clock Display**
- **Compact Package**  
0.300 x 0.500 inches  
Leads on 2.54 mm (0.1 inch) Centers
- **Choice of Colors**  
Red, AlGaAs Red, High Efficiency Red, Yellow, Green
- **Excellent Appearance**  
Evenly Lighted Segments  
Mitered Corners on Segments  
Surface Color Gives Optimum Contrast  
± 50° Viewing Angle
- **Design Flexibility**  
Common Anode or Common Cathode
- **Right Hand Decimal Point**  
± 1. Overflow Character
- **Categorized for Luminous Intensity**  
Yellow and Green Categorized for Color  
Use of Like Categories Yields a Uniform Display
- **High Light Output**
- **High Peak Current**
- **Excellent for Long Digit String Multiplexing**
- **Intensity and Color Selection Available**  
See Intensity and Color Selected Displays Data Sheet
- **Sunlight Viewable AlGaAs**

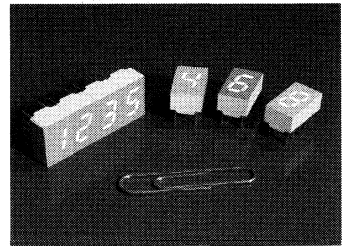

### Description

The 7.6 mm (0.3 inch) LED seven segment displays are designed for viewing distances up to 3 metres (10 feet). These devices use an industry standard size package and pinout. Both the numeric and

### Devices

Red HDSP-	AlGaAs <sup>[1]</sup> HDSP-	HER <sup>[1]</sup> HDSP-	Yellow <sup>[1]</sup> HDSP-	Green <sup>[1]</sup> HDSP-	Description	Package Drawing
7301	A151	7501	7401	7801	Common Anode Right Hand Decimal	A
7302		7502	7402	7802	Common Anode Right Hand Decimal, Colon	B
7303	A153	7503	7403	7803	Common Cathode Right Hand Decimal	C
7304		7504	7404	7804	Common Cathode Right Hand Decimal, Colon	D
7307	A157	7507	7407	7807	Common Anode ± 1. Overflow	E
7308	A158	7508	7408	7808	Common Cathode ± 1. Overflow	F

#### Note:

1. These displays are recommended for high ambient light operation. Please refer to the HDSP-A10X AlGaAs, HDSP-335X HER, HDSP-A80X Yellow, and HDSP-A90X Green data sheet for low current operation.

± 1. overflow devices feature a right hand decimal point. All devices are available as either common anode or common cathode.

These displays are ideal for most applications. Pin for pin equivalent displays are also available in a low current design. The low current displays are ideal for

portable applications. For additional information see the Low Current Seven Segment Displays.

### Package Dimensions

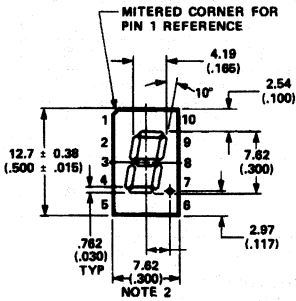

A, C

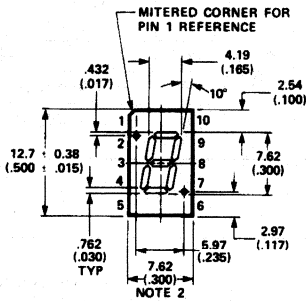

B, D

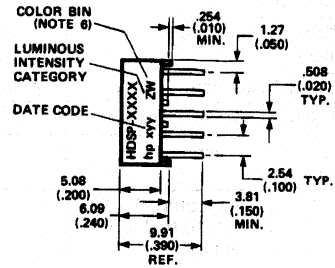

MITERED CORNER FOR PIN 1 REFERENCE

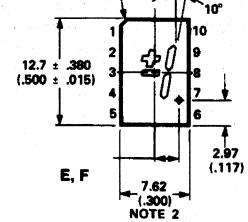

E, F

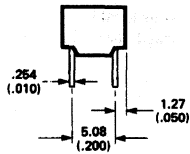

- NOTES:  
 1. ALL DIMENSIONS IN MILLIMETRES (INCHES).  
 2. MAXIMUM.  
 3. ALL UNTOLERANCED DIMENSIONS ARE FOR REFERENCE ONLY.  
 4. REDUNDANT ANODES.  
 5. REDUNDANT CATHODES.  
 6. FOR HDSP-7400/7800 SERIES PRODUCT ONLY.

PIN	FUNCTION					
	A	B	C	D	E	F
1	ANODE [4]	CATHODE COLON	CATHODE [5]	ANODE COLON	ANODE [4]	CATHODE [5]
2	CATHODE f	CATHODE f	ANODE f	ANODE f	CATHODE PLUS	ANODE PLUS
3	CATHODE g	CATHODE g	ANODE g	ANODE g	CATHODE MINUS	ANODE MINUS
4	CATHODE e	CATHODE e	ANODE e	ANODE e	NC	NC
5	CATHODE d	CATHODE d	ANODE d	ANODE d	NC	NC
6	ANODE [4]	ANODE	CATHODE [5]	CATHODE	ANODE [4]	CATHODE [5]
7	CATHODE DP	CATHODE DP	ANODE DP	ANODE DP	CATHODE DP	ANODE DP
8	CATHODE c	CATHODE c	ANODE c	ANODE c	CATHODE c	ANODE c
9	CATHODE b	CATHODE b	ANODE b	ANODE b	CATHODE b	ANODE b
10	CATHODE a	CATHODE a	ANODE a	ANODE a	NC	NC

### Internal Circuit Diagram

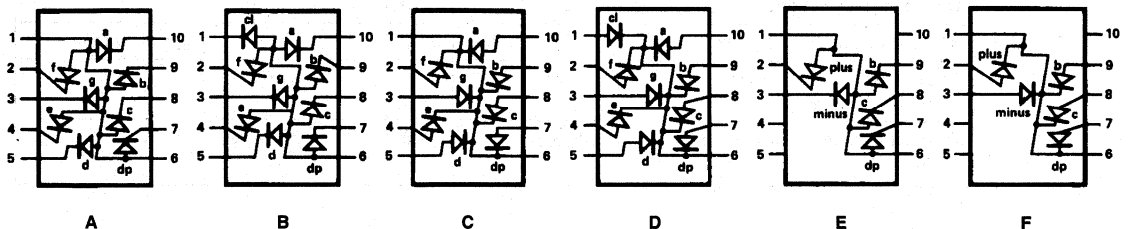

SEVEN SEGMENT NUMERIC DISPLAYS

## Absolute Maximum Ratings

Description	Red HDSP-7300 Series	AlGaAs Red HDSP-A150 Series	HER HDSP-7500 Series	Yellow HDSP-7400 Series	Green HDSP-7800 Series	Units
Average Power per Segment or DP	82	96	105	80	105	mW
Peak Forward Current per Segment or DP	150 <sup>[1]</sup>	160 <sup>[3]</sup>	90 <sup>[5]</sup>	60 <sup>[7]</sup>	90 <sup>[9]</sup>	mA
DC Forward Current per Segment or DP	25 <sup>[2]</sup>	40 <sup>[4]</sup>	30 <sup>[6]</sup>	20 <sup>[8]</sup>	30 <sup>[10]</sup>	mA
Operating Temperature Range	-40 to +100	-20 to +100 <sup>[11]</sup>	-40 to +100			°C
Storage Temperature Range	-55 to +100					°C
Reverse Voltage per Segment or DP	3.0					V
Lead Solder Temperature for 3 Seconds (1.60 mm [0.063 in.] below seating plane)	260					°C

### Notes:

- See Figure 1 to establish pulsed conditions.
- Derate above 80°C at 0.63 mA/°C.
- See Figure 2 to establish pulsed conditions.
- Derate above 46°C at 0.54 mA/°C.
- See Figure 7 to establish pulsed conditions.
- Derate above 53°C at 0.45 mA/°C.
- See Figure 8 to establish pulsed conditions.
- Derate above 81°C at 0.52 mA/°C.
- See Figure 9 to establish pulsed conditions.
- Derate above 39°C at 0.37 mA/°C.
- For operation below -20°C, contact your local HP components sales office or an authorized distributor.

## Electrical/Optical Characteristics at $T_A = 25^\circ\text{C}$

### Red

Device Series HDSP-	Parameter	Symbol	Min.	Typ.	Max.	Units	Test Conditions
730X	Luminous Intensity/Segment <sup>[1,2]</sup> (Digit Average)	$I_V$	600	1100		$\mu\text{cd}$	$I_F = 20\text{ mA}$
				500			$I_F = 10\text{ mA}$
All	Forward Voltage/Segment or DP	$V_F$		1.6	2.0	V	$I_F = 20\text{ mA}$
	Peak Wavelength	$\lambda_{\text{PEAK}}$		655		nm	
	Dominant Wavelength <sup>[3]</sup>	$\lambda_d$		640		nm	
	Reverse Voltage/Segment or DP <sup>[4]</sup>	$V_R$	3.0	12		V	$I_R = 100\text{ mA}$
	Temperature Coefficient of $V_F$ /Segment or DP	$\Delta V_F/^\circ\text{C}$		-2		mV/°C	
	Thermal Resistance LED Junction-to-Pin	$R\theta_{\text{J-PIN}}$		200		°C/W/Seg	



## AlGaAs Red

Device Series HDSP-	Parameter	Symbol	Min.	Typ.	Max.	Units	Test Conditions
A15X	Luminous Intensity/Segment <sup>[1,2,5]</sup> (Digit Average)	$I_V$	6.9	14.0		mcd	$I_F = 20 \text{ mA}$
	Forward Voltage/Segment or DP	$V_F$		1.8		V	$I_F = 20 \text{ mA}$
				2.0	3.0	V	$I_F = 100 \text{ mA}$
	Peak Wavelength	$\lambda_{PEAK}$		645		nm	
	Dominant Wavelength <sup>[3]</sup>	$\lambda_d$		637		nm	
	Reverse Voltage/Segment or DP <sup>[4]</sup>	$V_R$	3.0	15.0		V	$I_R = 100 \text{ }\mu\text{A}$
	Temperature Coefficient of $V_F$ /Segment or DP	$\Delta V_F/^\circ\text{C}$		-2		mV/°C	
Thermal Resistance LED Junction- to-Pin	$R\theta_{J-PIN}$		255		°C/W/Seg		

## High Efficiency Red

Device Series HDSP-	Parameter	Symbol	Min.	Typ.	Max.	Units	Test Conditions
750X	Luminous Intensity/Segment <sup>[1,2,6]</sup> (Digit Average)	$I_V$	360	980		$\mu\text{cd}$	$I_F = 5 \text{ mA}$
				5390			$I_F = 20 \text{ mA}$
	Forward Voltage/Segment or DP	$V_F$		2.0	2.5	V	$I_F = 20 \text{ mA}$
	Peak Wavelength	$\lambda_{PEAK}$		635		nm	
	Dominant Wavelength <sup>[3]</sup>	$\lambda_d$		626		nm	
	Reverse Voltage/Segment or DP <sup>[4]</sup>	$V_R$	3.0	30		V	$I_R = 100 \text{ }\mu\text{A}$
	Temperature Coefficient of $V_F$ /Segment or DP	$\Delta V_F/^\circ\text{C}$		-2		mV/°C	
Thermal Resistance LED Junction- to-Pin	$R\theta_{J-PIN}$		200		°C/W/Seg		

## Yellow

Device Series HDSP-	Parameter	Symbol	Min.	Typ.	Max.	Units	Test Conditions
740X	Luminous Intensity/Segment <sup>[1,2,7]</sup> (Digit Average)	I <sub>V</sub>	225	480		μcd	I <sub>F</sub> = 5 mA
				2740			I <sub>F</sub> = 20 mA
	Forward Voltage/Segment or DP	V <sub>F</sub>		2.2	2.5	V	I <sub>F</sub> = 20 mA
	Peak Wavelength	λ <sub>PEAK</sub>		583		nm	
	Dominant Wavelength <sup>[3,9]</sup>	λ <sub>d</sub>	581.5	586	592.5	nm	
	Reverse Voltage/Segment or DP <sup>[4]</sup>	V <sub>R</sub>	3.0	50.0		V	I <sub>R</sub> = 100 μA
	Temperature Coefficient of V <sub>F</sub> /Segment or DP	ΔV <sub>F</sub> /°C		-2		mV/°C	
Thermal Resistance LED Junction-to-Pin	Rθ <sub>J-PIN</sub>		200		°C/W/Seg		

## High Performance Green

Device Series HDSP-	Parameter	Symbol	Min.	Typ.	Max.	Units	Test Conditions
780X	Luminous Intensity/Segment <sup>[1,2,8]</sup> (Digit Average)	I <sub>V</sub>	860	3000		μcd	I <sub>F</sub> = 10 mA
				6800			I <sub>F</sub> = 20 mA
	Forward Voltage/Segment or DP	V <sub>F</sub>		2.1	2.5	V	I <sub>F</sub> = 10 mA
	Peak Wavelength	λ <sub>PEAK</sub>		566		nm	
	Dominant Wavelength <sup>[3,9]</sup>	λ <sub>d</sub>		571	577	nm	
	Reverse Voltage/Segment or DP <sup>[4]</sup>	V <sub>R</sub>	3.0	50.0		V	I <sub>R</sub> = 100 μA
	Temperature Coefficient of V <sub>F</sub> /Segment or DP	ΔV <sub>F</sub> /°C		-2		mV/°C	
Thermal Resistance LED Junction-to-Pin	Rθ <sub>J-PIN</sub>		200		°C/W/Seg		

### Notes:

- Case temperature of device immediately prior to the intensity measurement is 25°C.
- The digits are categorized for luminous intensity. The intensity category is designated by a letter on the side of the package.
- The dominant wavelength, λ<sub>d</sub>, is derived from the CIE chromaticity diagram and is that single wavelength which defines the color of the device.
- Typical specification for reference only. Do not exceed absolute maximum ratings.
- For low current operation the AlGaAs HDSP-A101 series displays are recommended.
- For low current operation the HER HDSP-7511 series displays are recommended.
- For low current operation the Yellow HDSP-A801 series displays are recommended.
- For low current operation the Green HDSP-A901 series displays are recommended.
- The yellow (HDSP-7400) and Green (HDSP-7800) displays are categorized for dominant wavelength. The category is designated by a number adjacent to the luminous intensity category letter.

## Red, AlGaAs Red

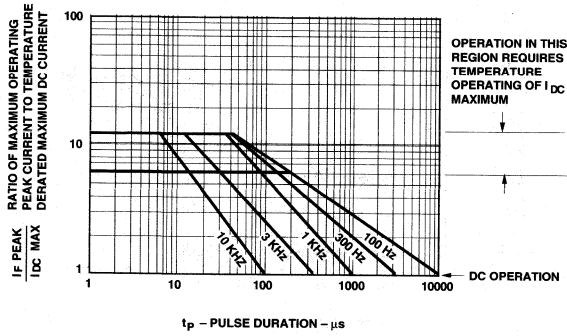

Figure 1. Maximum Tolerable Peak Current vs. Pulse Duration - Red.

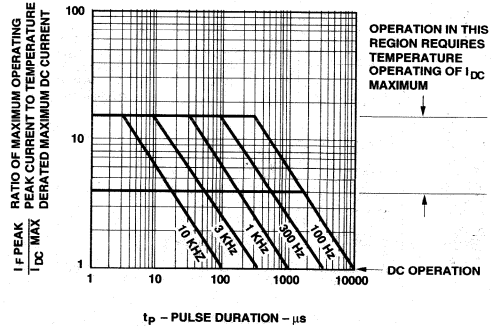

Figure 2. Maximum Allowed Peak Current vs. Pulse Duration - AlGaAs Red.

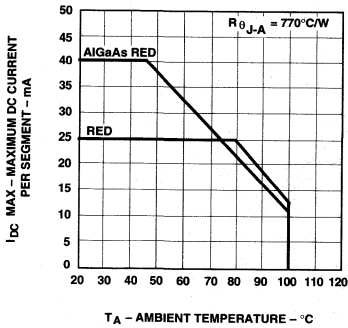

Figure 3. Maximum Allowable DC Current per Segment as a Function of Ambient Temperature.

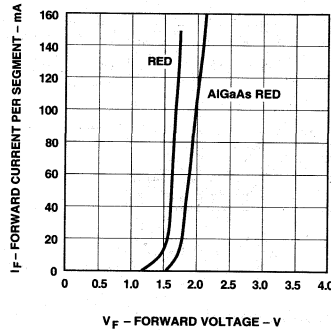

Figure 4. Forward Current vs. Forward Voltage.

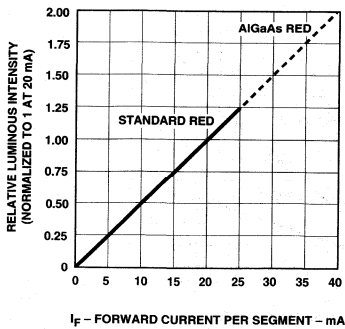

Figure 5. Relative Luminous Intensity vs. DC Forward Current.

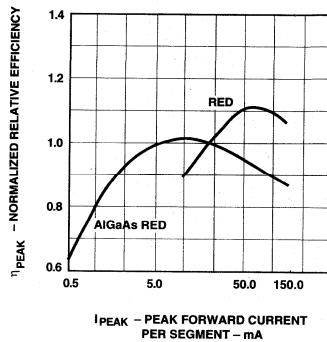

Figure 6. Relative Efficiency (Luminous Intensity per Unit Current) vs. Peak Current.

# HER, Yellow, Green

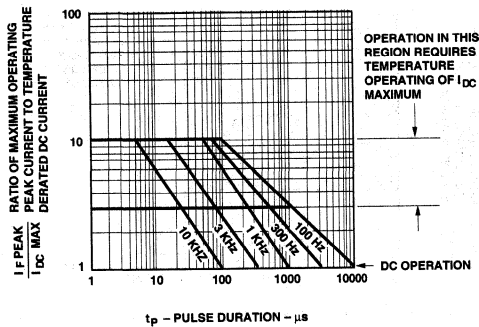

Figure 7. Maximum Tolerable Peak Current vs. Pulse Duration - HER.

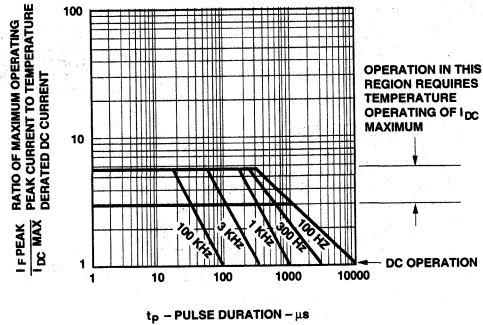

Figure 8. Maximum Tolerable Peak Current vs. Pulse Duration - Yellow.

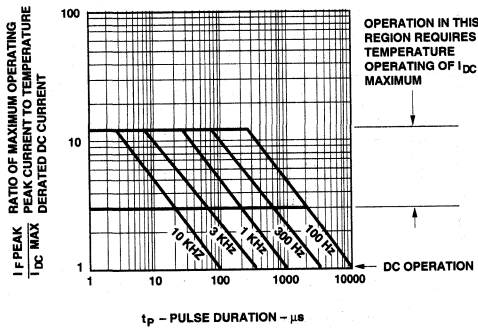

Figure 9. Allowable Peak Current vs. Pulse Duration - Green.

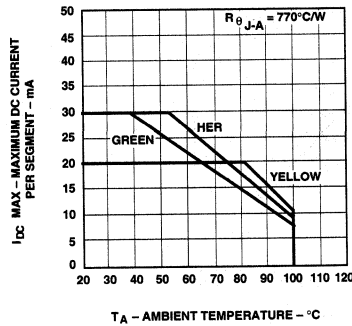

Figure 10. Maximum Allowable DC Current per Segment as a Function of Ambient Temperature.

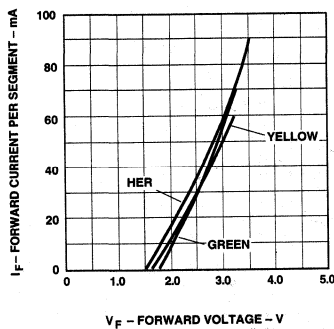

Figure 11. Forward Current vs. Forward Voltage Characteristics.

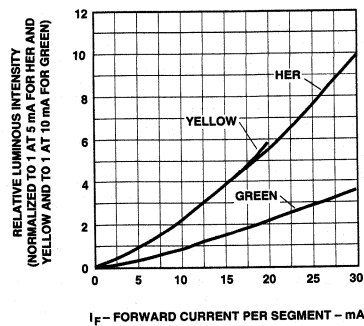
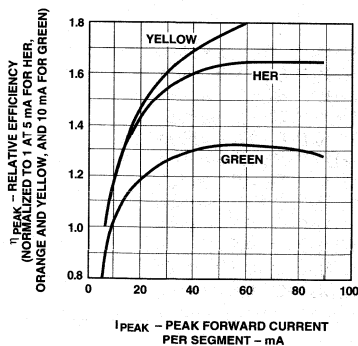

Figure 12. Relative Luminous Intensity vs. DC Forward Current.



**Figure 13. Relative Efficiency (Luminous Intensity per Unit Current) vs. Peak Current.**

### Contrast Enhancement

For information on contrast enhancement please see Application Note 1015.

### Soldering/Cleaning

Cleaning agents from the ketone family (acetone, methyl ethyl ketone, etc.) and from the chlorinated hydrocarbon family (methylene chloride, trichloroethylene, carbon tetrachloride, etc.) are not recommended for cleaning LED parts. All of these various solvents attack or dissolve the encapsulating epoxies used to form the package of plastic LED parts.

For further information on soldering LEDs please refer to Application Note 1027.

SEVEN SEGMENT  
NUMERIC DISPLAYS

# 10 mm (0.40 inch) Seven Segment Displays

## Technical Data

**HDSP-F00X Series**  
**HDSP-F15X Series**  
**HDSP-F20X Series**  
**HDSP-F30X Series**  
**HDSP-F40X Series**  
**HDSP-F50X Series**  
**HDSP-G00X Series**  
**HDSP-G15X Series**  
**HDSP-G20X Series**  
**HDSP-G30X Series**  
**HDSP-G40X Series**  
**HDSP-G50X Series**

### Features

- **Industry Standard Size**
- **Industry Standard Pinout**  
7.6 mm (0.3 inch) DIP Single  
15.24 mm (0.6 inch) DIP Dual  
Leads on 2.54 mm (0.1 inch) Centers
- **Choice of Colors**  
Red, AlGaAs Red, High Efficiency Red, Orange, Yellow, Green
- **Excellent Appearance**  
Evenly Lighted Segments  
Mitered Corners on Segments  
Gray Package Gives Optimum Contrast  
± 50° Viewing Angle
- **Design Flexibility**  
Common Anode or Common Cathode  
Single and Dual Digits  
Right Hand Decimal Point  
± 1. Overflow Character
- **Categorized for Luminous Intensity**  
Yellow and Green Categorized for Color  
Use of Like Categories Yields a Uniform Display
- **High Light Output**
- **High Peak Current**
- **Excellent for Long Digit String Multiplexing**

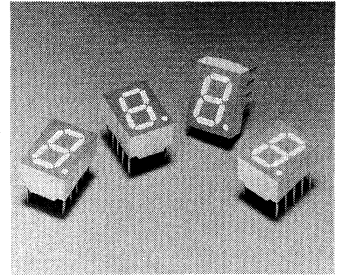

- **Intensity and Color Selection Option**
- **Sunlight Viewable AlGaAs**

### Devices

Red HDSP-	AlGaAs Red <sup>(1)</sup> HDSP-	HER HDSP-	Orange HDSP-	Yellow HDSP-	Green HDSP-	Description	Package Drawing
F001	F151	F201	F401	F301	F501	Common Anode Right Hand Decimal	A
F003	F153	F203	F403	F303	F503	Common Cathode Right Hand Decimal	B
F007	F157	F207	F407	F307	F507	Common Anode ± 1. Overflow	C
F008	F158	F208	F408	F308	F508	Common Cathode ± 1. Overflow	D
G001	G151	G201	G401	G301	G501	Two Digit Common Anode Right Hand Decimal	E
G003	G153	G203	G403	G303	G503	Two Digit Common Cathode Right Hand Decimal	F

**Note:**

1. These displays are recommended for high ambient light operation. Please refer to the HDSP-F10X data sheet for low current operation.

## Description

The 10 mm (0.40 inch) LED seven segment displays are HP's most space-efficient character size. They are designed for viewing distances up to 4.5

metres (15 feet). These devices use an industry standard size package and pinout. The dual numeric, single numeric, and  $\pm 1$ . overflow devices feature a right hand decimal point. All devices

are available as either common anode or common cathode.

Typical applications include instruments, point of sale terminals, and appliances.

## Package Dimensions

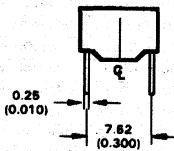
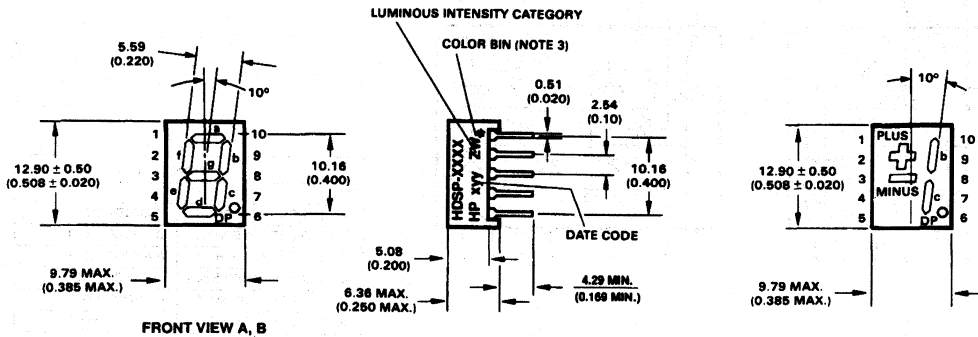

\*The End View of package indicates Country of Origin.

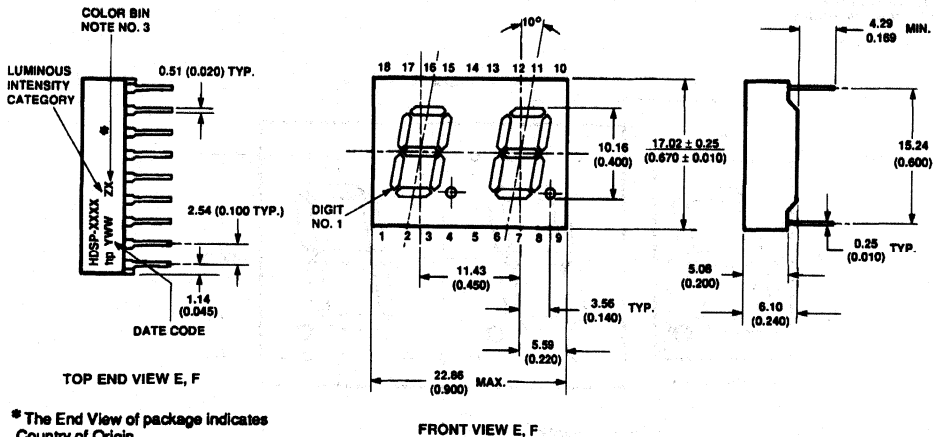

\*The End View of package indicates Country of Origin.

- NOTES:  
 1. DIMENSIONS ARE IN MILLIMETRES (INCHES).  
 2. ALL UNTOLERANCED DIMENSIONS ARE FOR REFERENCE ONLY.  
 3. WHERE APPLICABLE.

SEVEN SEGMENT  
 NUMERIC DISPLAYS

# Internal Circuit Diagram

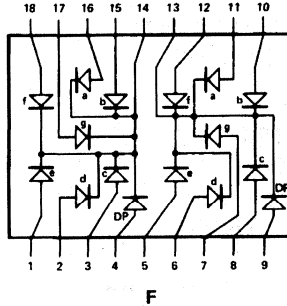
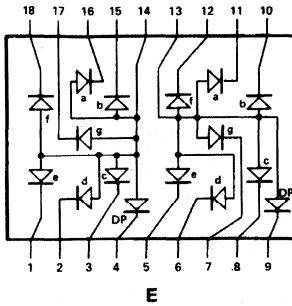
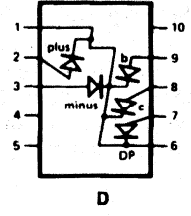
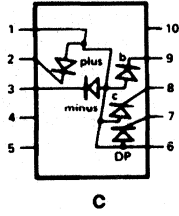
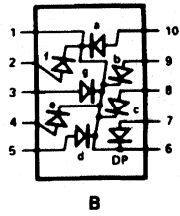
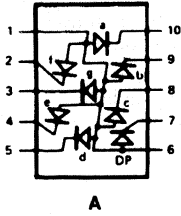

PIN	FUNCTION			
	A	B	C	D
1	ANODE <sup>(1)</sup>	CATHODE <sup>(2)</sup>	ANODE <sup>(1)</sup>	CATHODE <sup>(2)</sup>
2	CATHODE f	ANODE f	CATHODE PLUS	ANODE PLUS
3	CATHODE g	ANODE g	CATHODE MINUS	ANODE MINUS
4	CATHODE e	ANODE e	NC	NC
5	CATHODE d	ANODE d	NC	NC
6	ANODE <sup>(1)</sup>	CATHODE <sup>(2)</sup>	ANODE <sup>(1)</sup>	CATHODE <sup>(2)</sup>
7	CATHODE DP	ANODE DP	CATHODE DP	ANODE DP
8	CATHODE c	ANODE c	CATHODE c	ANODE c
9	CATHODE b	ANODE b	CATHODE b	ANODE b
10	CATHODE a	ANODE a	NC	NC

PIN	FUNCTION	
	E	F
1	E CATHODE NO. 1	E ANODE NO. 1
2	D CATHODE NO. 1	D ANODE NO. 1
3	C CATHODE NO. 1	C ANODE NO. 1
4	DP CATHODE NO. 1	DP ANODE NO. 1
5	E CATHODE NO. 2	E ANODE NO. 2
6	D CATHODE NO. 2	D ANODE NO. 2
7	G CATHODE NO. 2	G ANODE NO. 2
8	C CATHODE NO. 2	C ANODE NO. 2
9	CP CATHODE NO. 2	DP ANODE NO. 2
10	B CATHODE NO. 2	B ANODE NO. 2
11	A CATHODE NO. 2	A ANODE NO. 2
12	F CATHODE NO. 2	F ANODE NO. 2
13	DIGIT NO. 2 CATHODE	
14	DIGIT NO. 1 ANODE	
15	B CATHODE NO. 1	B ANODE NO. 1
16	A CATHODE NO. 1	A ANODE NO. 1
17	G CATHODE NO. 1	G ANODE NO. 1
18	F CATHODE NO. 1	F ANODE NO. 1

NOTES:  
 1. REDUNDANT ANODES  
 2. REDUNDANT CATHODES

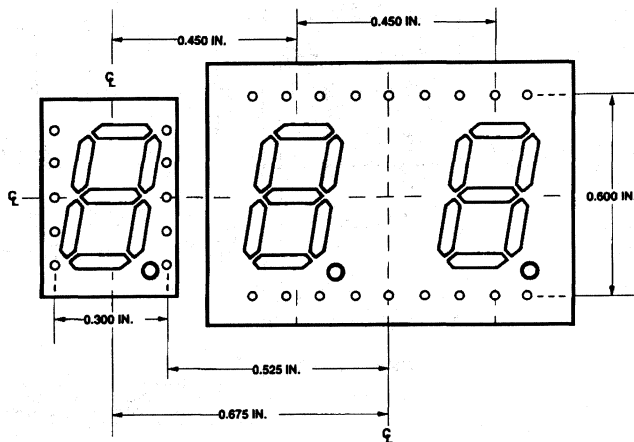

HOLE PATTERN FOR PCB LAYOUT TO ACHIEVE UNIFORM 0.450 IN. DIGIT TO DIGIT PITCH. FOR HDSP-FXXX TO HDSP-GXXX.



## Absolute Maximum Ratings

Description	Red HDSP-F00X/G00X Series	AlGaAs Red HDSP-F15X/G15X Series	HER/Orange HDSP-F20X/G20X/G40X Series	Yellow HDSP-F30X/G30X Series	Green HDSP-F50X/G50X Series	Units
Average Power per Segment or DP	82	96	105	80	105	mW
Peak Forward Current per Segment or DP	150 <sup>[1]</sup>	160 <sup>[3]</sup>	90 <sup>[7]</sup>	60 <sup>[7]</sup>	90 <sup>[9]</sup>	mA
DC Forward Current per Segment or DP	25 <sup>[2]</sup>	40 <sup>[4]</sup>	30 <sup>[6]</sup>	20 <sup>[8]</sup>	30 <sup>[10]</sup>	mA
Operating Temperature Range	-40 to +100	-20 to +100 <sup>[11]</sup>	-40 to +100			°C
Storage Temperature Range	-55 to +100					°C
Reverse Voltage per Segment or DP	3.0					V
Lead Solder Temperature for 3 Seconds (1.59 mm [0.63 in.] below seating plane)	260					°C

### Notes:

- See Figure 1 to establish pulsed conditions.
- Derate above 80°C at 0.63 mA/°C.
- See Figure 2 to establish pulsed conditions.
- Derate above 46°C at 0.54 mA/°C.
- See Figure 7 to establish pulsed conditions.
- Derate above 53°C at 0.45 mA/°C.
- See Figure 8 to establish pulsed conditions.
- Derate above 81°C at 0.52 mA/°C.
- See Figure 9 to establish pulsed conditions.
- Derate above 39°C at 0.37 mA/°C.
- For operation below -20°C, contact your local HP components sales office or an authorized distributor.

## Electrical/Optical Characteristics at T<sub>A</sub> = 25°C

### Red

Device Series	Parameter	Symbol	Min.	Typ.	Max.	Units	Test Conditions
HDSP-F00X/G00X	Luminous Intensity/Segment <sup>[1,2]</sup> (Digit Average)	I <sub>V</sub>	650	1200		μcd	I <sub>F</sub> = 20 mA
	Forward Voltage/Segment or DP	V <sub>F</sub>		1.6	2.0	V	I <sub>F</sub> = 20 mA
	Peak Wavelength	λ <sub>PEAK</sub>		655		nm	
	Dominant Wavelength <sup>[3]</sup>	λ <sub>d</sub>		640		nm	
	Reverse Voltage/Segment or DP <sup>[4]</sup>	V <sub>R</sub>	3.0	12		V	I <sub>F</sub> = 100 μA
	Temperature Coefficient of V <sub>F</sub> /Segment or DP	ΔV <sub>F</sub> /°C		-2		mV/°C	
	Thermal Resistance LED Junction-to-Pin	Rθ <sub>J-PIN</sub>		320		°C/W/Seg	

## AlGaAs Red

Device Series	Parameter	Symbol	Min.	Typ.	Max.	Units	Test Conditions
HDSP-F15X/ G15X	Luminous Intensity/Segment <sup>[1,2,5]</sup> (Digit Average)	$I_V$	7.5	15.0		mcd	$I_F = 20 \text{ mA}$
	Forward Voltage/Segment or DP	$V_F$		1.8	2.2	V	$I_F = 20 \text{ mA}$
	Peak Wavelength	$\lambda_{PEAK}$		645		nm	
	Dominant Wavelength <sup>[3]</sup>	$\lambda_d$		637		nm	
	Reverse Voltage/Segment or DP <sup>[4]</sup>	$V_R$	3.0	15		V	$I_R = 100 \mu\text{A}$
	Temperature Coefficient of $V_F$ /Segment or DP	$\Delta V_F/^\circ\text{C}$		-2		mV/°C	
	Thermal Resistance LED Junction-to-Pin	$R\theta_{J-PIN}$		320		°C/W/Seg	

## High Efficiency Red

Device Series	Parameter	Symbol	Min.	Typ.	Max.	Units	Test Conditions
HDSP-F20X/ G20X	Luminous Intensity/Segment <sup>[1,2]</sup> (Digit Average)	$I_V$	420	1200		$\mu\text{cd}$	$I_F = 5 \text{ mA}$
	Forward Voltage/Segment or DP	$V_F$		2.0	2.5	V	$I_F = 20 \text{ mA}$
	Peak Wavelength	$\lambda_{PEAK}$		635		nm	
	Dominant Wavelength <sup>[3]</sup>	$\lambda_d$		626		nm	
	Reverse Voltage/Segment or DP <sup>[4]</sup>	$V_R$	3.0	30		V	$I_R = 100 \mu\text{A}$
	Temperature Coefficient of $V_F$ /Segment or DP	$\Delta V_F/^\circ\text{C}$		-2		mV/°C	
	Thermal Resistance LED Junction-to-Pin	$R\theta_{J-PIN}$		320		°C/W/Seg	

## Orange

Device Series	Parameter	Symbol	Min.	Typ.	Max.	Units	Test Conditions
HDSP-F40X/ G40X	Luminous Intensity/Segment <sup>[1,2]</sup> (Digit Average)	$I_V$	420	1200		$\mu\text{cd}$	$I_F = 5 \text{ mA}$
	Forward Voltage/Segment or DP	$V_F$		2.0	2.5	V	$I_F = 20 \text{ mA}$
	Peak Wavelength	$\lambda_{\text{PEAK}}$		600		nm	
	Dominant Wavelength <sup>[3]</sup>	$\lambda_d$		603		nm	
	Reverse Voltage/Segment or DP <sup>[4]</sup>	$V_R$	3.0	30		V	$I_R = 100 \mu\text{A}$
	Temperature Coefficient of $V_F$ /Segment or DP	$\Delta V_F / ^\circ\text{C}$		-2		mV/ $^\circ\text{C}$	
	Thermal Resistance LED Junction-to-Pin	$R\theta_{J-PIN}$		320		$^\circ\text{C/W/Seg}$	

## Yellow

Device Series	Parameter	Symbol	Min.	Typ.	Max.	Units	Test Conditions
HDSP-F30X/ G30X	Luminous Intensity/Segment <sup>[1,2]</sup> (Digit Average)	$I_V$	290	800		$\mu\text{cd}$	$I_F = 5 \text{ mA}$
	Forward Voltage/Segment or DP	$V_F$		2.2	2.5	V	$I_F = 20 \text{ mA}$
	Peak Wavelength	$\lambda_{\text{PEAK}}$		583		nm	
	Dominant Wavelength <sup>[3,6]</sup>	$\lambda_d$	581.5	586	592.5	nm	
	Reverse Voltage/Segment or DP <sup>[4]</sup>	$V_R$	3.0	40		V	$I_R = 100 \mu\text{A}$
	Temperature Coefficient of $V_F$ /Segment or DP	$\Delta V_F / ^\circ\text{C}$		-2		mV/ $^\circ\text{C}$	
	Thermal Resistance LED Junction-to-Pin	$R\theta_{J-PIN}$		320		$^\circ\text{C/W/Seg}$	

## High Performance Green

Device Series	Parameter	Symbol	Min.	Typ.	Max.	Units	Test Conditions
HDSP-F50X/G50X	Luminous Intensity/Segment <sup>[1,2]</sup> (Digit Average)	$I_V$	1030	3500		$\mu\text{cd}$	$I_F = 10 \text{ mA}$
	Forward Voltage/Segment or DP	$V_F$		2.1	2.5	V	$I_F = 10 \text{ mA}$
	Peak Wavelength	$\lambda_{\text{PEAK}}$		566		nm	
	Dominant Wavelength <sup>[3,6]</sup>	$\lambda_d$		571	577	nm	
	Reverse Voltage/Segment or DP <sup>[4]</sup>	$V_R$	3.0	50		V	$I_R = 100 \mu\text{A}$
	Temperature Coefficient of $V_F$ /Segment or DP	$\Delta V_F / ^\circ\text{C}$		-2		$\text{mV}/^\circ\text{C}$	
	Thermal Resistance LED Junction-to-Pin	$R\theta_{\text{J-PIN}}$		320		$^\circ\text{C}/\text{W}/\text{Seg}$	

### Notes:

1. Case temperature of device immediately prior to the intensity measurement is 25°C.
2. The digits are categorized for luminous intensity. The intensity category is designated by a letter on the side of the package.
3. The dominant wavelength,  $\lambda_d$ , is derived from the CIE chromaticity diagram and is that single wavelength which defines the color of the device.
4. Typical specification for reference only. Do not exceed absolute maximum ratings.
5. For low current operation, the AlGaAs HDSP-F10X, G10X series displays are recommended. They are tested at 1 mA dc/segment and are pin for pin compatible with the HDSP-F15X/G15X series.
6. The Yellow (HDSP-F30X/G30X) series and Green (HDSP-F50X/G50X) series displays are categorized for dominant wavelength. The category is designated by a number adjacent to the luminous intensity category letter.

# RED, AlGaAs Red

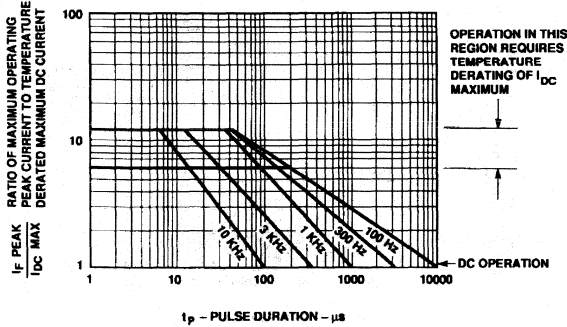

Figure 1. Maximum Tolerable Peak Current vs. Pulse Duration - Red.

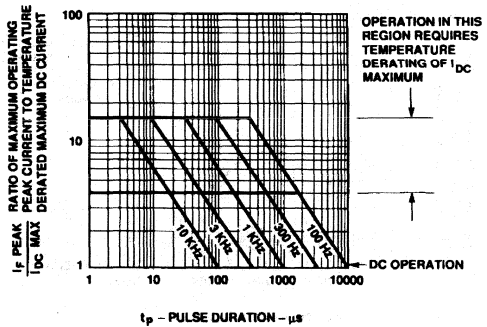

Figure 2. Maximum Tolerable Peak Current vs. Pulse Duration - AlGaAs Red.

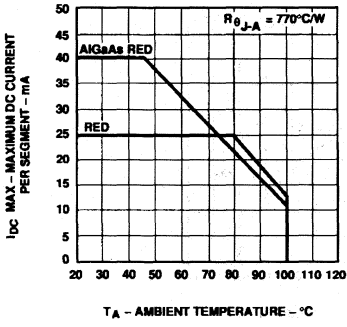

Figure 3. Maximum Allowable DC Current vs. Ambient Temperature.

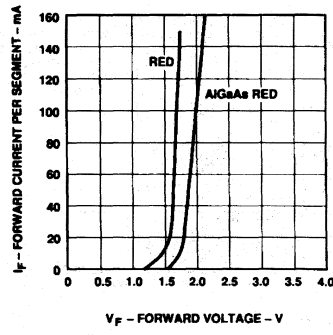

Figure 4. Forward Current vs. Forward Voltage.

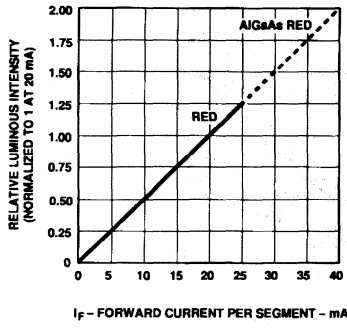

Figure 5. Relative Luminous Intensity vs. DC Forward Current.

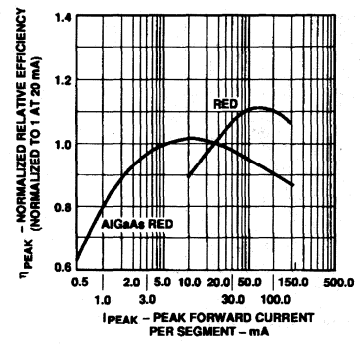

Figure 6. Relative Efficiency (Luminous Intensity per Unit Current) vs. Peak Current.

SEVEN SEGMENT NUMERIC DISPLAYS

# HER, Orange, Yellow, Green

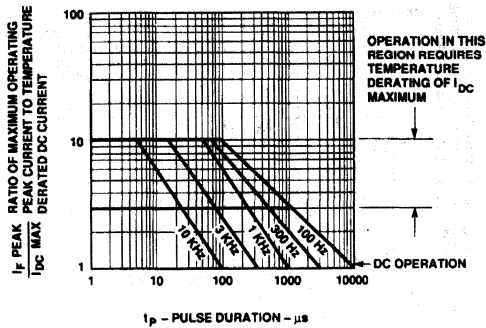

Figure 7. Maximum Tolerable Peak Current vs. Pulse Duration - HER, Orange.

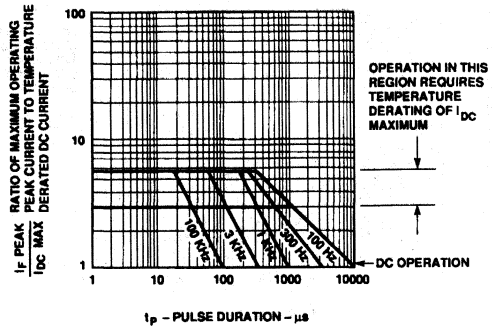

Figure 8. Maximum Tolerable Peak Current vs. Pulse Duration - Yellow.

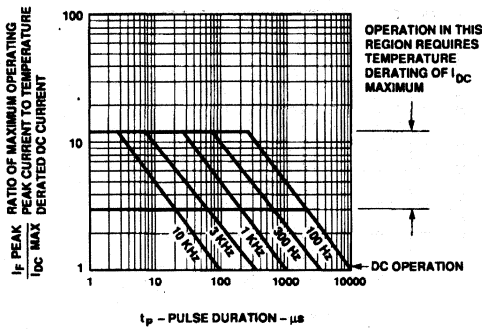

Figure 9. Maximum Tolerable Peak Current vs. Pulse Duration - Green.

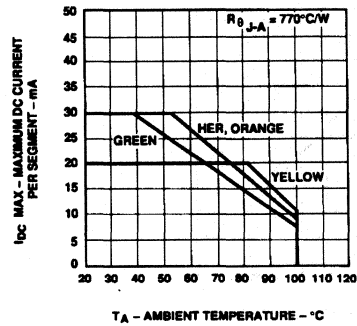

Figure 10. Maximum Allowable DC Current vs. Ambient Temperature.

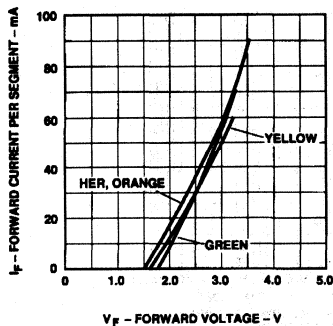

Figure 11. Forward Current vs. Forward Voltage Characteristics.

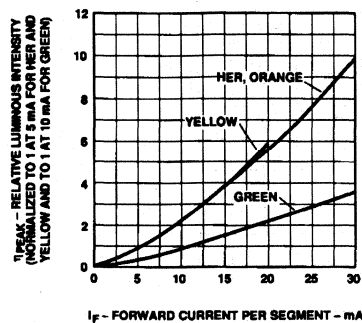

Figure 12. Relative Luminous Intensity vs. DC Forward Current.

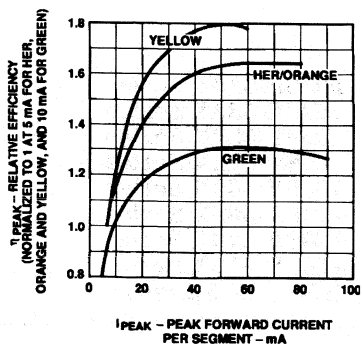

Figure 13. Relative Efficiency (Luminous Intensity per Unit Current) vs. Peak Current.

### Contrast Enhancement

For information on contrast enhancement please see Application Note 1015.

### Soldering/Cleaning

Cleaning agents from the ketone family (acetone, methyl ethyl ketone, etc.) and from the chlorinated hydrocarbon family (methylene chloride, trichloroethylene, carbon tetrachloride, etc.) are not recommended for cleaning LED parts. All of these various solvents attack or dissolve the encapsulating epoxies used to form the package of plastic LED parts.

For further information on soldering LEDs please refer to Application Note 1027.

# 14.2 mm (0.56 inch) Seven Segment Displays

## Technical Data

**HDSP-530X Series**  
**HDSP-532X Series**  
**HDSP-550X Series**  
**HDSP-552X Series**  
**HDSP-560X Series**  
**HDSP-562X Series**  
**HDSP-570X Series**  
**HDSP-572X Series**  
**HDSP-H15X Series**

### Features

- **Industry Standard Size**
- **Industry Standard Pinout**  
15.24 mm (0.6 in.) DIP Leads  
on 2.54 mm (0.1 in.) Centers
- **Choice of Colors**  
Red, AlGaAs Red, High  
Efficiency Red, Yellow, Green
- **Excellent Appearance**  
Evenly Lighted Segments  
Mitered Corners on Segments  
Gray Package Gives Optimum  
Contrast  
± 50° Viewing Angle
- **Design Flexibility**  
Common Anode or Common  
Cathode  
Single and Dual Digits  
Right Hand Decimal Point  
± 1. Overflow Character

- **Categorized for Luminous Intensity**  
Yellow and Green Categorized  
for Color  
Use of Like Categories Yields a  
Uniform Display
- **High Light Output**
- **High Peak Current**
- **Excellent for Long Digit String Multiplexing**
- **Intensity and Color Selection Option**  
See Intensity and Color  
Selected Displays Data Sheet
- **Sunlight Viewable AlGaAs**

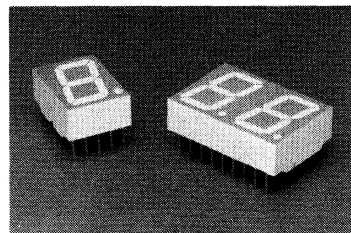

### Description

The 14.2 mm (0.56 inch) LED seven segment displays are designed for viewing distances up

to 7 metres (23 feet). These devices use an industry standard size package and pinout. Both the numeric and ± 1 overflow devices feature a right hand decimal point. All devices are available as either common anode or common cathode.

### Devices

Red HDSP-	AlGaAs Red HDSP-[1]	HER HDSP-[1]	Yellow HDSP-	Green HDSP-	Description	Package Drawing
5301	H151	5501	5701	5601	Common Anode Right Hand Decimal	A
5303	H153	5503	5703	5603	Common Cathode Right Hand Decimal	B
5307	H157	5507	5707	5607	Common Anode ± 1. Overflow	C
5308	H158	5508	5708	5608	Common Cathode ± 1. Overflow	D
5321		5521	5721	5621	Two Digit Common Anode Right Hand Decimal	E
5323		5523	5723	5623	Two Digit Common Cathode Right Hand Decimal	F

#### Note:

1. These displays are recommended for high ambient light operation. Please refer to the HDSP-H10X/K12X AlGaAs and HDSP-555X HER data sheet for low current operation.



These displays are ideal for most applications. Pin for pin equivalent displays are also available in a low current design. The low current displays are ideal

for portable applications. For additional information see the Low Current Seven Segment Displays data sheet.

### Package Dimensions

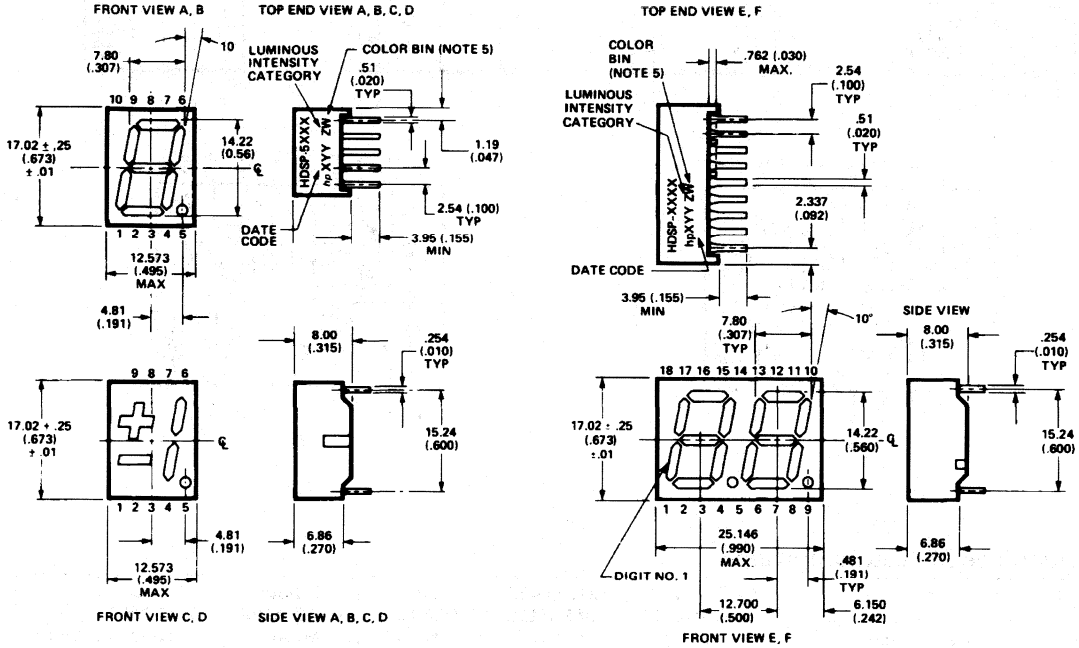

SEVEN SEGMENT  
NUMERIC DISPLAYS

PIN	FUNCTION					
	A	B	C	D	E	F
1	CATHODE e	ANODE e	CATHODE c	ANODE c	E CATHODE NO. 1	E ANODE NO. 1
2	CATHODE d	ANODE d	ANODE c, d	CATHODE c, d	D CATHODE NO. 1	D ANODE NO. 1
3	ANODE <sup>(5)</sup>	CATHODE <sup>(4)</sup>	CATHODE b	ANODE b	C CATHODE NO. 1	C ANODE NO. 1
4	CATHODE c	ANODE c	ANODE a, b, DP	CATHODE a, b, DP	DP CATHODE NO. 1	DP ANODE NO. 1
5	CATHODE DP	ANODE DP	CATHODE DP	ANODE DE	E CATHODE NO. 1	E ANODE NO. 2
6	CATHODE b	ANODE b	CATHODE a	ANODE a	D CATHODE NO. 2	D ANODE NO. 2
7	CATHODE a	ANODE a	ANODE a, b, DP	CATHODE a, b, DP	G CATHODE NO. 2	G ANODE NO. 2
8	ANODE <sup>(5)</sup>	CATHODE <sup>(4)</sup>	ANODE c, d	CATHODE c, d	C CATHODE NO. 2	C ANODE NO. 2
9	CATHODE f	ANODE f	CATHODE d	ANODE d	DP CATHODE NO. 2	DP ANODE NO. 2
10	CATHODE g	ANODE g	NO PIN	NO PIN	B CATHODE NO. 2	B ANODE NO. 2
11					A CATHODE NO. 2	A ANODE NO. 2
12					F CATHODE NO. 2	F ANODE NO. 2
13					DIGIT NO. 2 ANODE	DIGIT NO. 2 CATHODE
14					DIGIT NO. 1 ANODE	DIGIT NO. 1 CATHODE
15					B CATHODE NO. 1	B ANODE NO. 1
16					A CATHODE NO. 1	A ANODE NO. 1
17					G CATHODE NO. 1	G ANODE NO. 1
18					F CATHODE NO. 1	F ANODE NO. 1

**NOTES:**

- ALL DIMENSIONS IN MILLIMETRES (INCHES).
- ALL UNTOLERANCED DIMENSIONS ARE FOR REFERENCE ONLY.
- REDUNDANT ANODES.
- REDUNDANT CATHODES.
- FOR HDSP-5600/5700 SERIES PRODUCT ONLY.

## Internal Circuit Diagram

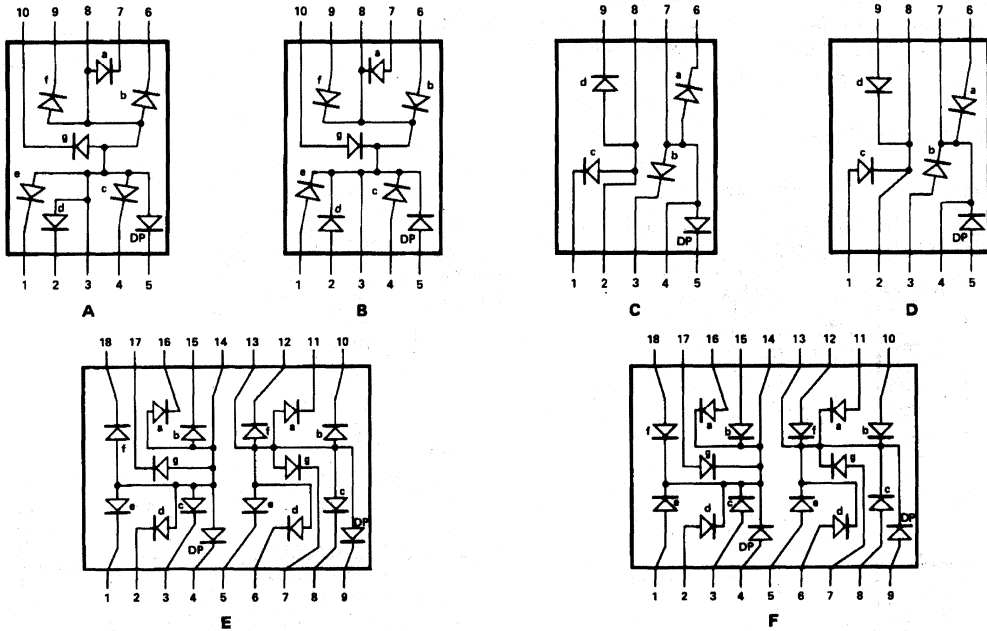

## Absolute Maximum Ratings

Description	Red HDSP-5300 Series	AlGaAs Red HDSP-H150 Series	HER HDSP-5500 Series	Yellow HDSP-5700 Series	Green HDSP-5600 Series	Units
Average Power per Segment or DP	82	96	105	80	105	mW
Peak Forward Current per Segment or DP	150 <sup>[1]</sup>	160 <sup>[3]</sup>	90 <sup>[5]</sup>	60 <sup>[7]</sup>	90 <sup>[9]</sup>	mA
DC Forward Current per Segment or DP	25 <sup>[2]</sup>	40 <sup>[4]</sup>	30 <sup>[6]</sup>	20 <sup>[8]</sup>	30 <sup>[10]</sup>	mA
Operating Temperature Range	-40 to +100	-20 to +100 <sup>[11]</sup>	-40 to +100			°C
Storage Temperature Range	-55 to +100					°C
Reverse Voltage per Segment or DP	3.0					V
Lead Solder Temperature for 3 Seconds (1.60 mm [0.063 in.] below seating plane)	260					°C

### Notes:

- See Figure 1 to establish pulsed conditions.
- Derate above 80°C at 0.63 mA/°C.
- See Figure 2 to establish pulsed conditions.
- Derate above 46°C at 0.54 mA/°C.
- See Figure 7 to establish pulsed conditions.
- Derate above 53°C at 0.45 mA/°C.
- See Figure 8 to establish pulsed conditions.
- Derate above 81°C at 0.52 mA/°C.
- See Figure 9 to establish pulsed conditions.
- Derate above 39°C at 0.37 mA/°C.
- For operation below -20°C, contact your local HP components sales office or an authorized distributor.

## Electrical/Optical Characteristics at $T_A = 25^\circ\text{C}$

### Red

Device Series HDSP-	Parameter	Symbol	Min.	Typ.	Max.	Units	Test Conditions
53XX	Luminous Intensity/Segment <sup>[1,2]</sup> (Digit Average)	$I_V$	600	1300		$\mu\text{cd}$	$I_F = 20\text{ mA}$
				1400			$I_F = 100\text{ mA Peak:}$ $1\text{ of }5\text{ df}$
	Forward Voltage/Segment or DP	$V_F$		1.6	2.0	V	$I_F = 20\text{ mA}$
	Peak Wavelength	$\lambda_{\text{PEAK}}$		655		nm	
	Dominant Wavelength <sup>[3]</sup>	$\lambda_d$		640		nm	
	Reverse Voltage/Segment or DP <sup>[4]</sup>	$V_R$	3.0	12		V	$I_R = 100\ \mu\text{A}$
	Temperature Coefficient of $V_F$ /Segment or DP	$\Delta V_F/^\circ\text{C}$		-2		$\text{mV}/^\circ\text{C}$	
Thermal Resistance LED Junction-to-Pin	$R\theta_{J\text{-Pin}}$		345		$^\circ\text{C}/\text{W}/\text{Seg}$		

### AlGaAs Red

Device Series HDSP-	Parameter	Symbol	Min.	Typ.	Max.	Units	Test Conditions
H15X	Luminous Intensity/Segment <sup>[1,2,5]</sup> (Digit Average)	$I_V$	9.1	16.0		$\text{mcd}$	$I_F = 20\text{ mA}$
	Forward Voltage/Segment or DP	$V_F$		1.8		V	$I_F = 20\text{ mA}$
				2.0	3.0		$I_F = 100\text{ mA}$
	Peak Wavelength	$\lambda_{\text{PEAK}}$		645		nm	
	Dominant Wavelength <sup>[3]</sup>	$\lambda_d$		637		nm	
	Reverse Voltage/Segment or DP <sup>[4]</sup>	$V_R$	3.0	15		V	$I_R = 100\ \mu\text{A}$
	Temperature Coefficient of $V_F$ /Segment or DP	$\Delta V_F/^\circ\text{C}$		-2		$\text{mV}/^\circ\text{C}$	
Thermal Resistance LED Junction-to-Pin	$R\theta_{J\text{-Pin}}$		400		$^\circ\text{C}/\text{W}/\text{Seg}$		

SEVEN SEGMENT  
NUMERIC DISPLAYS

## High Efficiency Red

Device Series HDSP-	Parameter	Symbol	Min.	Typ.	Max.	Units	Test Conditions
55XX	Luminous Intensity/Segment <sup>[1,2,6]</sup> (Digit Average)	I <sub>V</sub>	900	2800		μcd	I <sub>F</sub> = 10 mA
				3700			I <sub>F</sub> = 60 mA Peak: 1 of 6 df
	Forward Voltage/Segment or DP	V <sub>F</sub>		2.1	2.5	V	I <sub>F</sub> = 20 mA
	Peak Wavelength	λ <sub>PEAK</sub>		635		nm	
	Dominant Wavelength <sup>[3]</sup>	λ <sub>d</sub>		626		nm	
	Reverse Voltage/Segment or DP <sup>[4]</sup>	V <sub>R</sub>	3.0	30		V	I <sub>R</sub> = 100 μA
	Temperature Coefficient of V <sub>F</sub> /Segment or DP	ΔV <sub>F</sub> /°C		-2		mV/°C	
Thermal Resistance LED Junction-to-Pin	Rθ <sub>J-Pin</sub>		345		°C/W/ Seg		

## Yellow

Device Series HDSP-	Parameter	Symbol	Min.	Typ.	Max.	Units	Test Conditions
57XX	Luminous Intensity/Segment <sup>[1,2]</sup> (Digit Average)	I <sub>V</sub>	600	1800		μcd	I <sub>F</sub> = 10 mA
				2750			I <sub>F</sub> = 60 mA Peak: 1 of 6 df
	Forward Voltage/Segment or DP	V <sub>F</sub>		2.1	2.5	V	I <sub>F</sub> = 20 mA
	Peak Wavelength	λ <sub>PEAK</sub>		583		nm	
	Dominant Wavelength <sup>[3,7]</sup>	λ <sub>d</sub>	581.5	586	592.5	nm	
	Reverse Voltage/Segment or DP <sup>[4]</sup>	V <sub>R</sub>	3.0	40		V	I <sub>R</sub> = 100 μA
	Temperature Coefficient of V <sub>F</sub> /Segment or DP	ΔV <sub>F</sub> /°C		-2		mV/°C	
Thermal Resistance LED Junction-to-Pin	Rθ <sub>J-Pin</sub>		345		°C/W/ Seg		

## High Performance Green

Device Series HDSP-	Parameter	Symbol	Min.	Typ.	Max.	Units	Test Conditions
56XX	Luminous Intensity/Segment <sup>[1,2]</sup> (Digit Average)	$I_V$	900	2500		$\mu\text{cd}$	$I_F = 10 \text{ mA}$
				3100			$I_F = 60 \text{ mA Peak:}$ 1 of 6 df
	Forward Voltage/Segment or DP	$V_F$		2.1	2.5	V	$I_F = 10 \text{ mA}$
	Peak Wavelength	$\lambda_{\text{PEAK}}$		566		nm	
	Dominant Wavelength <sup>[3,7]</sup>	$\lambda_d$		571	577	nm	
	Reverse Voltage/Segment or DP <sup>[4]</sup>	$V_R$	3.0	50		V	$I_R = 100 \mu\text{A}$
	Temperature Coefficient of $V_F$ /Segment or DP	$\Delta V_F / ^\circ\text{C}$		-2		mV/ $^\circ\text{C}$	
Thermal Resistance LED Junction-to-Pin	$R\theta_{\text{J-Pin}}$		345		$^\circ\text{C/W/Seg}$		

### Notes:

- Device case temperature is 25°C prior to the intensity measurement.
- The digits are categorized for luminous intensity. The intensity category is designated by a letter on the side of the package.
- The dominant wavelength,  $\lambda_d$ , is derived from the CIE chromaticity diagram and is that single wavelength which defines the color of the device.
- Typical specification for reference only. Do not exceed absolute maximum ratings.
- For low current operation, the AlGaAs HDSP-H10X series displays are recommended. They are tested at 1 mA dc/segment and are pin for pin compatible with the HDSP-H15X series.
- For low current operation, the HER HDSP-555X series displays are recommended. They are tested at 2 mA dc/segment and are pin for pin compatible with the HDSP-550X series.
- The Yellow (HDSP-5700) and Green (HDSP-5600) displays are categorized for dominant wavelength. The category is designated by a number adjacent to the luminous intensity category letter.

## Red, AlGaAs Red

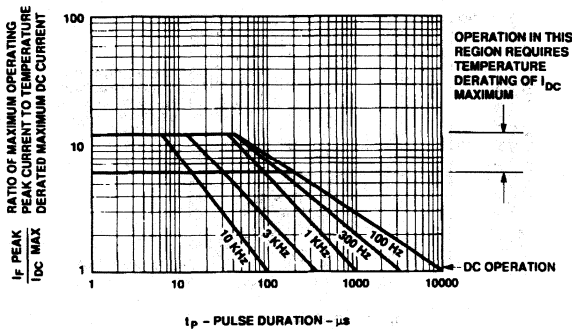

Figure 1. Maximum Tolerable Peak Current vs. Pulse Duration - Red.

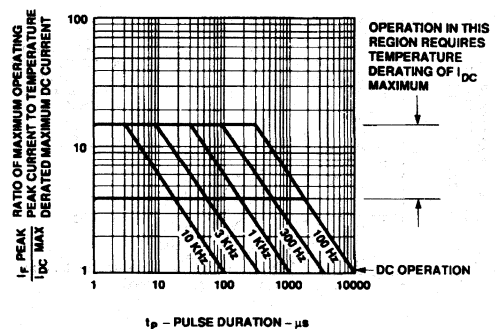

Figure 2. Maximum Tolerable Peak Current vs. Pulse Duration - AlGaAs Red.

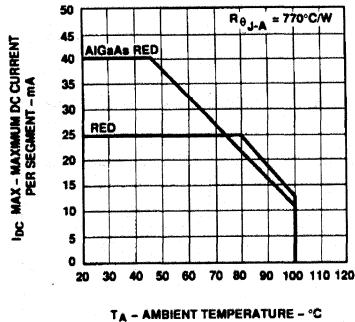

Figure 3. Maximum Allowable DC Current vs. Ambient Temperature.

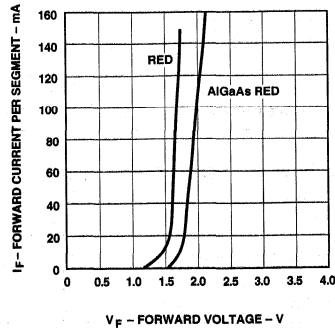

Figure 4. Forward Current vs. Forward Voltage.

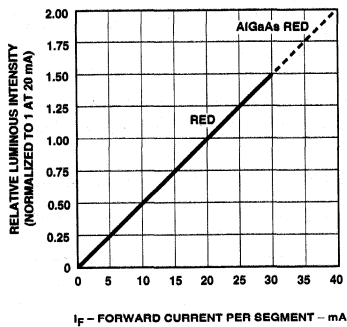

Figure 5. Relative Luminous Intensity vs. DC Forward Current.

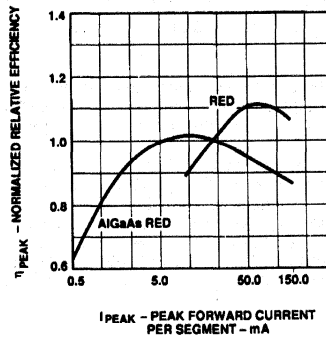

Figure 6. Relative Efficiency (Luminous Intensity per Unit Current) vs. Peak Current.

## HER, Yellow, Green

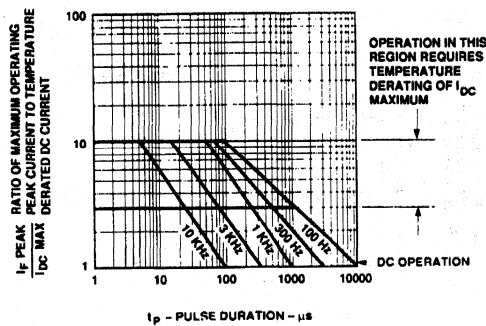

Figure 7. Maximum Tolerable Peak Current vs. Pulse Duration - HER.

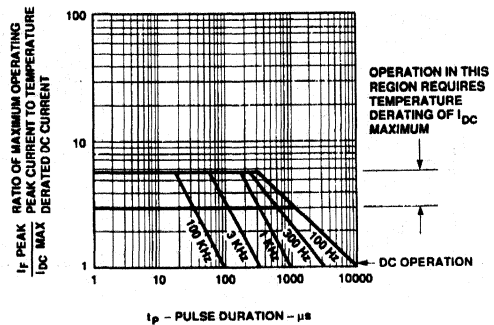

Figure 8. Maximum Tolerable Peak Current vs. Pulse Duration - Yellow.

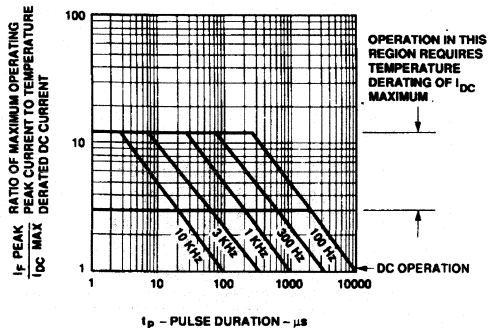

Figure 9. Maximum Tolerable Peak Current vs. Pulse Duration - Green.

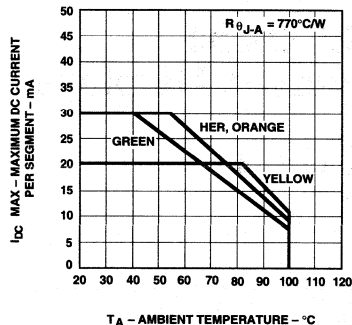

Figure 10. Maximum Allowable DC Current vs. Ambient Temperature.

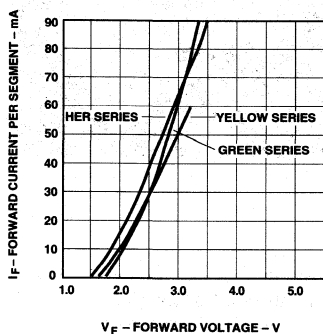

Figure 11. Forward Current vs. Forward Voltage.

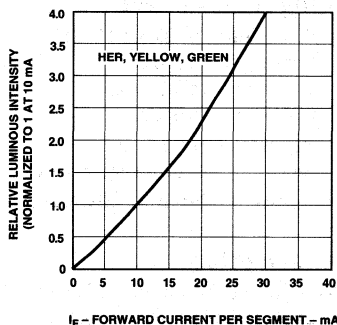

Figure 12. Relative Luminous Intensity vs. DC Forward Current.

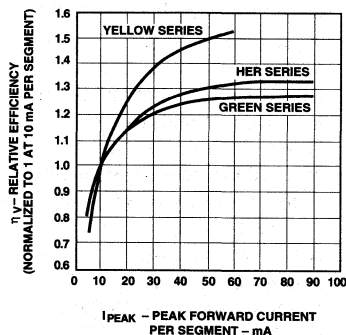

Figure 13. Relative Efficiency (Luminous Intensity per Unit Current) vs. Peak Current.

## Electrical/Optical

For more information on electrical/optical characteristics, please see Application Note 1005.

## Contrast Enhancement

For information on contrast enhancement please see Application Note 1015.

## Soldering/Cleaning

Cleaning agents from the ketone family (acetone, methyl ethyl ketone, etc.) and from the chlorinated hydrocarbon family

(methylene chloride, trichloroethylene, carbon tetrachloride, etc.) are not recommended for cleaning LED parts. All of these various solvents attack or dissolve the encapsulating epoxies used to form the package of plastic LED parts.

For information on soldering LEDs please refer to Application Note 1027.

SEVEN SEGMENT  
NUMERIC DISPLAYS

# 20 mm (0.8 inch) Seven Segment Displays

## Technical Data

**HDSP-340X Series  
HDSP-390X Series  
HDSP-420X Series  
HDSP-860X Series  
HDSP-N15X Series**

### Features

- **Industry Standard Size**
- **Industry Standard Pinout**  
15.24 mm (0.6 in.) DIP Leads  
on 2.54 mm (0.1 in.) Centers
- **Choice of Colors**  
Red, AlGaAs Red, High  
Efficiency Red, Yellow, Green
- **Excellent Appearance**  
Evenly Lighted Segments  
Mitered Corners on Segments  
Gray Package Gives Optimum  
Contrast  
± 50° Viewing Angle
- **Design Flexibility**  
Common Anode or Common  
Cathode  
Left and Right Hand Decimal  
Points  
± 1. Overflow Character
- **Categorized for Luminous  
Intensity**  
Yellow and Green Categorized

for Color

Use of Like Categories Yields a  
Uniform Display

- **High Light Output**
- **High Peak Current**
- **Excellent for Long Digit  
String Multiplexing  
Intensity and Color  
Selection Option**  
See Intensity and Color  
Selected Displays Data Sheet
- **Sunlight Viewable AlGaAs**

### Description

The 20 mm (0.8 inch) LED seven  
segment displays are designed  
for viewing distances up to 10  
metres (33 feet). These devices  
use an industry standard size  
package and pinout. All devices  
are available as either common  
anode or common cathode.

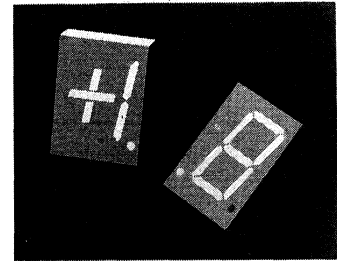

These displays are ideal for most  
applications. Pin for pin  
equivalent displays are also  
available in a low current design.  
The low current displays are ideal  
for portable applications. For  
additional information see the  
Low Current Seven Segment  
Displays data sheet.

### Devices

Red HDSP-	AlGaAs <sup>(1)</sup> HDSP-	HER HDSP-	Yellow HDSP-	Green HDSP-	Description	Package Drawing
3400	N150	3900	4200	8600	Common Anode Left Hand Decimal	A
3401	N151	3901	4201	8601	Common Anode Right Hand Decimal	B
3403	N153	3903	4203	8603	Common Cathode Right Hand Decimal	C
3405	N155	3905	4205	8605	Common Cathode Left Hand Decimal	D
3406	N156	3906	4206	8606	Universal ± 1. Overflow <sup>(2)</sup>	E

#### Notes:

1. These displays are recommended for high ambient light operation. Please refer to the HDSP-N10X AlGaAs data sheet for low current operation.
2. Universal pinout brings the anode and cathode of each segment's LED out to separate pins. See internal diagram E.



# Package Dimensions

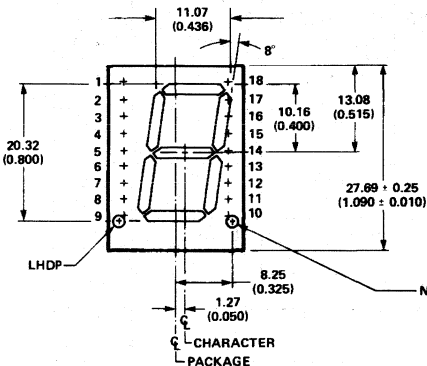

FRONT VIEW A, D

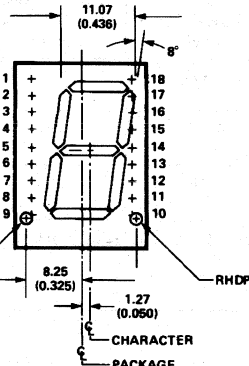

FRONT VIEW B, C

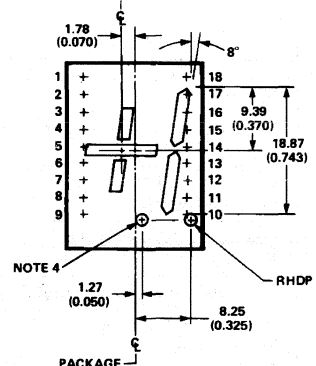

FRONT VIEW E

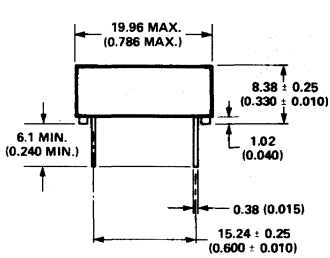

END VIEW

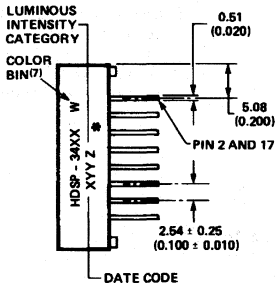

SIDE VIEW

\* The Side View of package indicates Country of Origin.

Pin	Function				
	A	B	C	D	E
1	NO PIN	NO PIN	NO PIN	NO PIN	NO PIN
2	CATHODE a	CATHODE a	ANODE a	ANODE a	CATHODE a
3	CATHODE f	CATHODE f	ANODE f	ANODE f	ANODE d
4	ANODE <sup>[2]</sup>	ANODE <sup>[2]</sup>	CATHODE <sup>[6]</sup>	CATHODE <sup>[6]</sup>	CATHODE d
5	CATHODE e	CATHODE e	ANODE e	ANODE e	CATHODE c
6	ANODE <sup>[3]</sup>	ANODE <sup>[3]</sup>	CATHODE <sup>[6]</sup>	CATHODE <sup>[6]</sup>	CATHODE e
7	CATHODE dp	NO CONNec	NO CONNec	ANODE dp	ANODE e
8	NO PIN	NO PIN	NO PIN	NO PIN	CATHODE dp
9	NO PIN	NO PIN	NO PIN	NO PIN	NO PIN
10	NO PIN	CATHODE dp	ANODE dp	NO PIN	ANODE dp
11	CATHODE d	CATHODE d	ANODE d	ANODE d	CATHODE dp
12	ANODE <sup>[3]</sup>	ANODE <sup>[3]</sup>	CATHODE <sup>[6]</sup>	CATHODE <sup>[6]</sup>	CATHODE b
13	CATHODE c	CATHODE c	ANODE c	ANODE c	ANODE b
14	CATHODE g	CATHODE g	ANODE g	ANODE g	ANODE c
15	CATHODE b	CATHODE b	ANODE b	ANODE b	ANODE a
16	NO PIN	NO PIN	NO PIN	NO PIN	NO PIN
17	ANODE <sup>[3]</sup>	ANODE <sup>[3]</sup>	CATHODE <sup>[6]</sup>	CATHODE <sup>[6]</sup>	CATHODE a
18	NO PIN	NO PIN	NO PIN	NO PIN	NO PIN

- NOTES:  
 1. DIMENSIONS IN MILLIMETERS AND INCHES.  
 2. ALL UNTOLERANCED DIMENSIONS ARE FOR REFERENCE ONLY.  
 3. REDUNDANT ANODES.  
 4. UNUSED dp POSITION.  
 5. SEE INTERNAL CIRCUIT DIAGRAM.  
 6. REDUNDANT CATHODES.  
 7. FOR HDSP-4200/-8600 SERIES PRODUCT ONLY.

# Internal Circuit Diagram

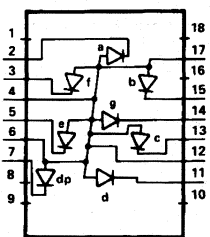

A

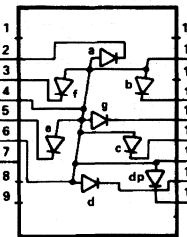

B

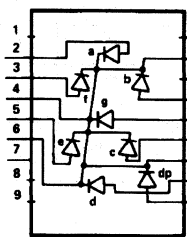

C

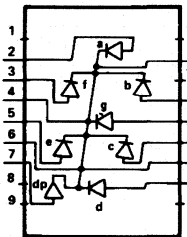

D

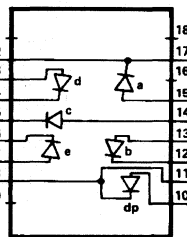

E

SEVEN SEGMENT NUMERIC DISPLAYS

## Absolute Maximum Ratings

Description	Red HDSP-3400 Series	AlGaAs Red HDSP-N150 Series	HER HDSP-3900 Series	Yellow HDSP-4200 Series	Green HDSP-8600 Series	Units
Average Power per Segment or DP	115	96	105	105	105	mW
Peak Forward Current per Segment or DP	200 <sup>[1]</sup>	160 <sup>[3]</sup>	135 <sup>[5]</sup>	135 <sup>[5]</sup>	90 <sup>[7]</sup>	mA
DC Forward Current per Segment or DP	50 <sup>[2]</sup>	40 <sup>[4]</sup>	40 <sup>[6]</sup>	40 <sup>[6]</sup>	30 <sup>[8]</sup>	mA
Operating Temperature Range	-40 to +100	-20 to +100 <sup>[9]</sup>	-40 to +100		-40 to +100	°C
Storage Temperature Range	-55 to +100					°C
Reverse Voltage per Segment or DP	3.0					V
Lead Solder Temperature for 3 Seconds (1.60 mm [0.063 in.] below seating plane)	260					°C

### Notes:

- See Figure 1 to establish pulsed conditions.
- Derate above 45°C at 0.83 mA/°C.
- See Figure 2 to establish pulsed conditions.
- Derate above 55°C at 0.8 mA/°C.
- See Figure 7 to establish pulsed conditions.

- Derate above 50°C at 0.73 mA/°C.
- See Figure 8 to establish pulsed conditions.
- Derate above 50°C at 0.54 mA/°C.
- For operation below -20°C, contact your local HP components sales office or an authorized distributor.

## Electrical/Optical Characteristics at T<sub>A</sub> = 25°C

### Red

Device Series	Parameter	Symbol	Min.	Typ.	Max.	Units	Test Conditions
HDSP-340X	Luminous Intensity/Segment <sup>[1,2]</sup> (Digit Average)	I <sub>V</sub>	500	1200		μcd	I <sub>F</sub> = 20 mA
	Forward Voltage/Segment or DP	V <sub>F</sub>		1.6	2.0	V	I <sub>F</sub> = 20 mA
	Peak Wavelength	λ <sub>PEAK</sub>		655		nm	
	Dominant Wavelength <sup>[3]</sup>	λ <sub>d</sub>		640		nm	
	Reverse Voltage/Segment or DP <sup>[4]</sup>	V <sub>R</sub>	3.0	20		V	I <sub>R</sub> = 100 μA
	Temperature Coefficient of V <sub>F</sub> /Segment or DP	ΔV <sub>F</sub> /°C		-2		mV/°C	
	Thermal Resistance LED Junction-to-Pin	Rθ <sub>J-PIN</sub>		375		°C/W	

### AlGaAs Red

Device Series	Parameter	Symbol	Min.	Typ.	Max.	Units	Test Conditions
HDSP-N15X	Luminous Intensity/Segment <sup>[1,2,5]</sup> (Digit Average)	$I_V$	6.0	14.0		mcd	$I_F = 20 \text{ mA}$
	Forward Voltage/Segment or DP	$V_F$		1.8		V	$I_F = 20 \text{ mA}$
				2.0	3.0	V	$I_F = 100 \text{ mA}$
	Peak Wavelength	$\lambda_{PEAK}$		645		nm	
	Dominant Wavelength <sup>[3]</sup>	$\lambda_d$		637		nm	
	Reverse Voltage/Segment or DP <sup>[4]</sup>	$V_R$	3.0	15		V	$I_R = 100 \mu\text{A}$
	Temperature Coefficient of $V_F$ /Segment or DP	$\Delta V_F/^\circ\text{C}$		-2		mV/ $^\circ\text{C}$	
Thermal Resistance LED Junction-to-Pin	$R\theta_{J-PIN}$		430		$^\circ\text{C}/\text{W}/\text{Seg}$		

### High Efficiency Red

Device Series	Parameter	Symbol	Min.	Typ.	Max.	Units	Test Conditions
HDSP-390X	Luminous Intensity/Segment <sup>[1,2]</sup> (Digit Average)	$I_V$	3350	7000		$\mu\text{cd}$	$I_F = 100 \text{ mA}$ Peak: 1 of 5 df
				4800		$\mu\text{cd}$	$I_F = 20 \text{ mA}$
	Forward Voltage/Segment or DP	$V_F$		2.6	3.5	V	$I_F = 100 \text{ mA}$
	Peak Wavelength	$\lambda_{PEAK}$		635		nm	
	Dominant Wavelength <sup>[3]</sup>	$\lambda_d$		626		nm	
	Reverse Voltage/Segment or DP <sup>[4]</sup>	$V_R$	3.0	25		V	$I_R = 100 \mu\text{A}$
	Temperature Coefficient of $V_F$ /Segment or DP	$\Delta V_F/^\circ\text{C}$		-2		mV/ $^\circ\text{C}$	
Thermal Resistance LED Junction-to-Pin	$R\theta_{J-PIN}$		375		$^\circ\text{C}/\text{W}/\text{Seg}$		

## Yellow

Device Series	Parameter	Symbol	Min.	Typ.	Max.	Units	Test Conditions
HDSP-420X	Luminous Intensity/Segment <sup>[1,2]</sup> (Digit Average)	I <sub>V</sub>	2200	7000		μcd	I <sub>F</sub> = 100 mA Peak: 1 of 5 df
				3400		μcd	I <sub>F</sub> = 20 mA
	Forward Voltage/Segment or DP	V <sub>F</sub>		2.6	3.5	V	I <sub>F</sub> = 100 mA
	Peak Wavelength	λ <sub>PEAK</sub>		583		nm	
	Dominant Wavelength <sup>[3,6]</sup>	λ <sub>d</sub>	581.5	586	592.5	nm	
	Reverse Voltage/Segment or DP <sup>[4]</sup>	V <sub>R</sub>	3.0	25.0		V	I <sub>R</sub> = 100 μA
	Temperature Coefficient of V <sub>F</sub> /Segment or DP	ΔV <sub>F</sub> /°C		-2		mV/°C	
Thermal Resistance LED Junction-to-Pin	Rθ <sub>J-PIN</sub>		375		°C/W/ Seg		

## Green

Device Series	Parameter	Symbol	Min.	Typ.	Max.	Units	Test Conditions
HDSP-860X	Luminous Intensity/Segment <sup>[1,2]</sup> (Digit Average)	I <sub>V</sub>	680	1500		μcd	I <sub>F</sub> = 10 mA
				1960		μcd	I <sub>F</sub> = 50 mA Peak: 1 of 5 df
	Forward Voltage/Segment or DP	V <sub>F</sub>		2.1	2.5	V	I <sub>F</sub> = 10 mA
	Peak Wavelength	λ <sub>PEAK</sub>		566		nm	
	Dominant Wavelength <sup>[3,6]</sup>	λ <sub>d</sub>		571	577	nm	
	Reverse Voltage/Segment or DP <sup>[4]</sup>	V <sub>R</sub>	3.0	50.0		V	I <sub>R</sub> = 100 μA
	Temperature Coefficient of V <sub>F</sub> /Segment or DP	ΔV <sub>F</sub> /°C		-2		mV/°C	
Thermal Resistance LED Junction-to-Pin	Rθ <sub>J-PIN</sub>		375		°C/W/ Seg		

### Notes:

- Case temperature of the device immediately prior to the intensity measurement is 25°C.
- The digits are categorized for luminous intensity. The intensity category is designated by a letter on the side of the package.
- The dominant wavelength, λ<sub>d</sub>, is derived from the CIE chromaticity diagram and is that single wavelength which defines the color of the device.
- Typical specification for reference only. Do not exceed absolute maximum ratings.
- For low current operation, the AlGaAs Red HDSP-N100 series displays are recommended. They are tested at 1 mA dc/segment and are pin for pin compatible with the HDSP-N150 series.
- The Yellow (HDSP-4200) and Green (HDSP-8600) displays are categorized for dominant wavelength. The category is designated by a number adjacent to the luminous intensity category letter.

## Red, AlGaAs Red

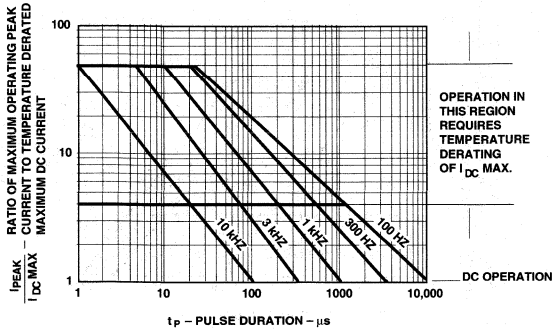

Figure 1. Maximum Allowable Peak Current vs. Pulse Duration - Red.

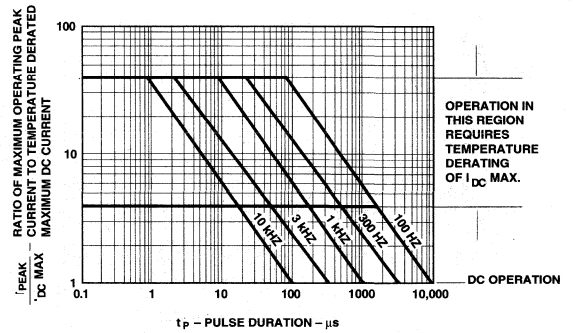

Figure 2. Maximum Allowed Peak Current vs. Pulse Duration - AlGaAs Red.

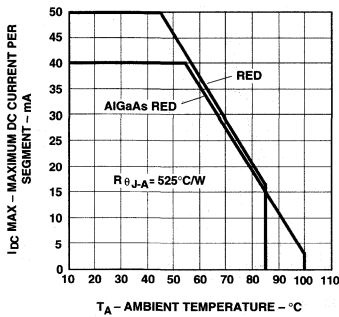

Figure 3. Maximum Allowable DC Current vs. Ambient Temperature.

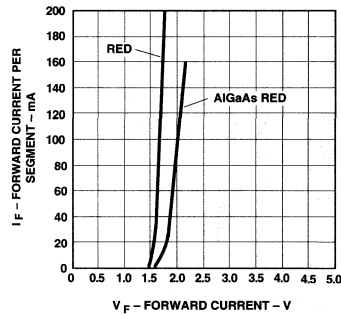

Figure 4. Forward Current vs. Forward Voltage.

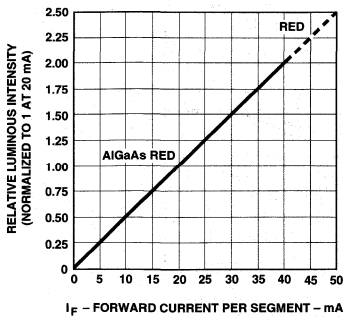

Figure 5. Relative Luminous Intensity vs. DC Forward Current.

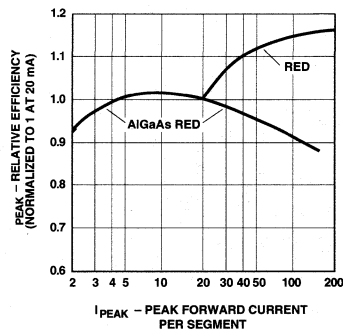

Figure 6. Relative Efficiency (Luminous Intensity per Unit Current) vs. Peak Current.

## HER, Yellow, Green

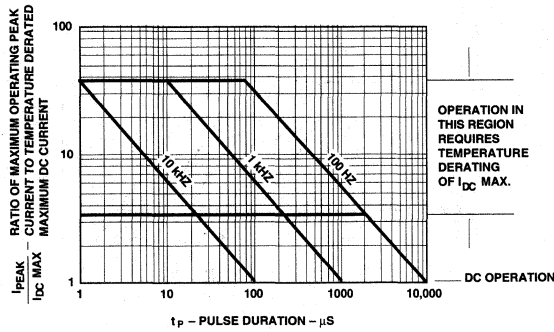

Figure 7. Maximum Allowed Peak Current vs. Pulse Duration - HER, Yellow.

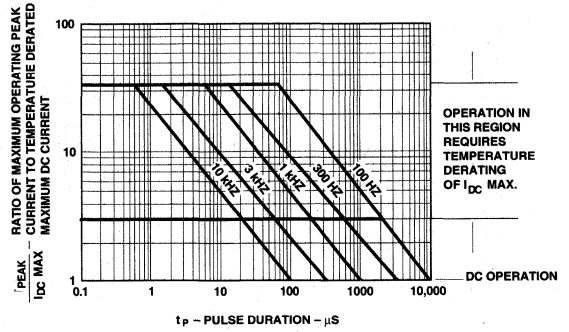

Figure 8. Maximum Allowed Peak Current vs. Pulse Duration - Green.

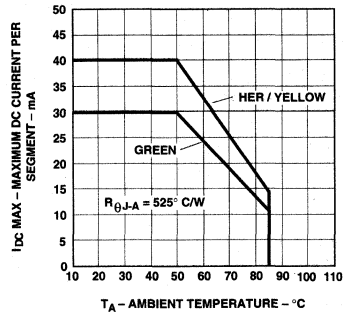

Figure 9. Maximum Allowable DC Current vs. Ambient Temperature.

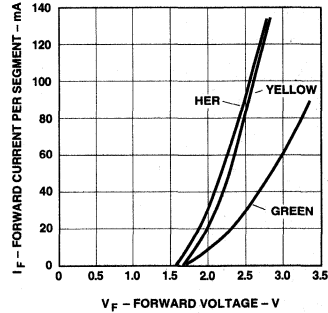

Figure 10. Forward Current vs. Forward Voltage.

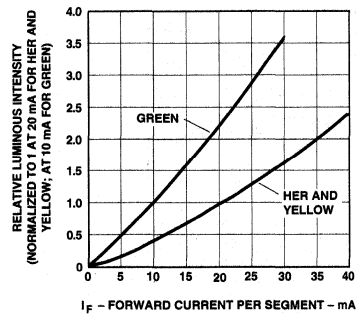

Figure 11. Relative Luminous Intensity vs. DC Forward Current.

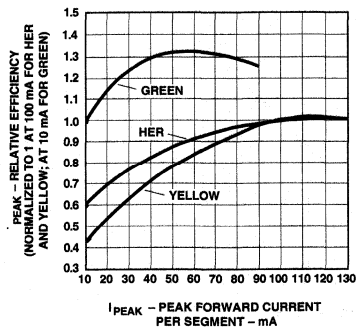

Figure 12. Relative Efficiency (Luminous Intensity per Unit Current) vs. Peak Current.

## **Contrast Enhancement**

For information on contrast enhancement please see Application Note 1015.

## **Soldering/Cleaning**

Cleaning agents from the ketone family (acetone, methyl ethyl ketone, etc.) and from the chlorinated hydrocarbon family (methylene chloride, trichloroethylene, carbon tetrachloride, etc.) are not recommended for cleaning LED parts. All of these various solvents attack or dissolve the encapsulating epoxies used to form the package of plastic LED parts.

For information on soldering LEDs please refer to Application Note 1027.

# CMOS 5 x 7 Small Alphanumeric Displays

## Technical Data

**HCMS-270X Series**  
**HCMS-271X Series**  
**HCMS-272X Series**

### Features

- **On-Board Low Power CMOS ICs**  
Integrated Shift Registers with Constant Current LED Drivers
- **Wide Operating Temperature Range**  
-40°C to +85°C
- **Three Package Styles**  
1 Row of 4 Characters  
1 Row of 8 Characters  
2 Rows of 8 Characters
- **Five LED Colors**  
Standard Red  
High Efficiency Red  
Orange  
Yellow  
High Performance Green
- **5 x 7 LED Matrix**  
Displays Full ASCII Character Set
- **Character Height**  
3.8 mm (0.15 inch)
- **Long Viewing Distance**  
2.6 Metres (8.6 Feet)
- **Wide Viewing Angle**  
X Axis =  $\pm 30^\circ$   
Y Axis =  $\pm 55^\circ$
- **Categorized for Luminous Intensity**

- **Categorized for Color**  
HCMS-2701/-2703  
HCMS-2711/-2713  
HCMS-2721/-2723

### Typical Applications

- **Telecommunications Equipment**
- **Instrumentation**
- **Medical Instruments**
- **Business Machines**

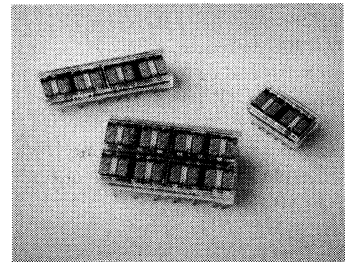

### Device Selection Guide

Part Number	Display Package Style	LED Color
HCMS-2700 -2701 -2702 -2703 -2704	1 Row of 4 Characters	Standard Red Yellow HER Green Orange
HCMS-2710 -2711 -2712 -2713 -2714	1 Row of 8 Characters	Standard Red Yellow HER Green Orange
HCMS-2720 -2721 -2722 -2723 -2724	2 Rows of 8 Characters	Standard Red Yellow HER Green Orange



### Description

The HCMS-270X series are four character 5x7 dot matrix alphanumeric displays in a dual in-line 12 pin plastic package. The on-board CMOS ICs form a 28 bit shift register.

The HCMS-271X series are eight character 5x7 dot matrix alphanumeric displays in a dual in-line plastic package with 26 pin positions. The on-board CMOS ICs form a 56 bit shift register.

The HCMS-272X series are sixteen character 5x7 dot matrix alphanumeric displays. Each device is assembled by enclosing two HCMS-271X devices in a common lens assembly forming two rows of eight characters. The plastic package has two dual in-line rows of 26 pin positions for a total of 52 pin positions. The two on-board CMOS IC 56 bit shift registers for each row are electrically separate from each other.

The on-board CMOS ICs form serial input shift registers with constant current output LED row drivers. Decoded column data is clocked into the shift registers for each refresh cycle. Full character display is accomplished with external column strobing at a refresh rate of 100 Hz or faster.

All of these display devices may be end stacked in the X-direction to form a string of characters of desired length.

### Package Dimensions

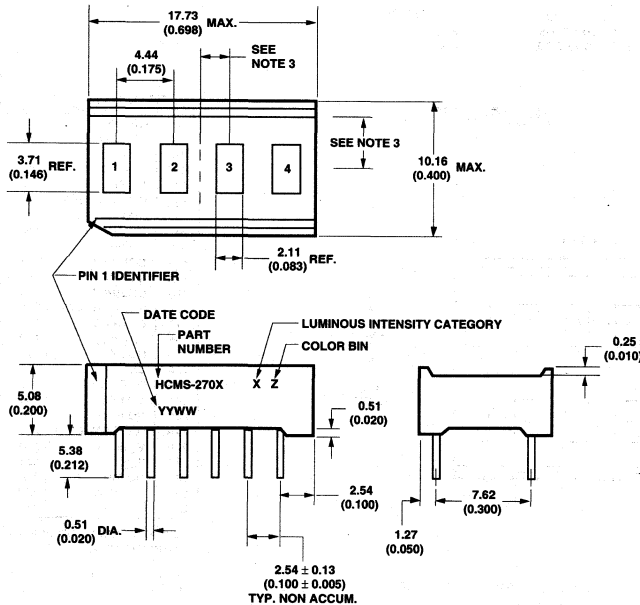

PIN	FUNCTION	PIN	FUNCTION
1	COLUMN 1	7	DATA OUT
2	COLUMN 2	8	V <sub>B</sub>
3	COLUMN 3	9	V <sub>D</sub>
4	COLUMN 4	10	CLOCK
5	COLUMN 5	11	GROUND
6	INT. CONNECT*	12	DATA IN

\* DO NOT CONNECT OR USE.

- NOTES:
1. DIMENSIONS IN MILLIMETRES/INCHES.
  2. UNLESS OTHERWISE SPECIFIED THE TOLERANCE ON ALL DIMENSIONS IS 0.38MM (0.015").
  3. CHARACTERS ARE CENTERED WITH RESPECT TO LEAD WITHIN 0.13MM (0.005").
  4. LEAD MATERIAL: SOLDER PLATED COPPER ALLOY.

### HCMS-270X

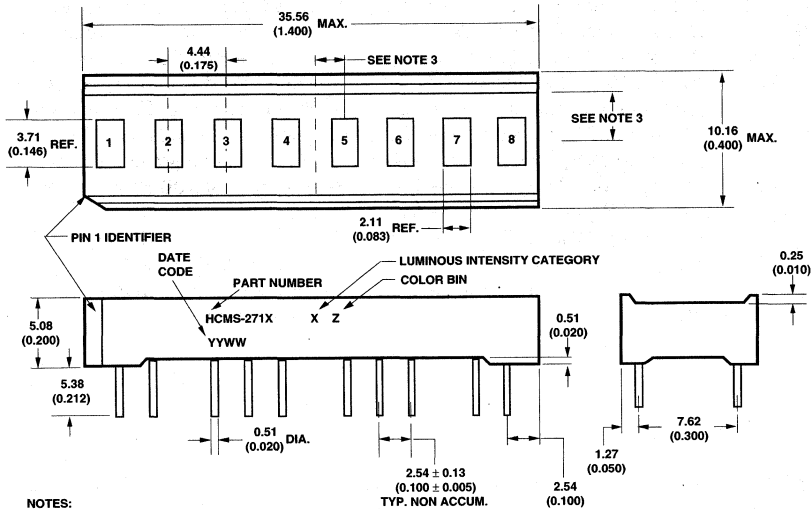

- NOTES:
1. DIMENSIONS IN MILLIMETRES/INCHES.
  2. UNLESS OTHERWISE SPECIFIED THE TOLERANCE ON ALL DIMENSIONS IS 0.38MM (0.015").
  3. CHARACTERS ARE CENTERED WITH RESPECT TO LEAD WITHIN 0.13MM (0.005").
  4. LEAD MATERIAL: SOLDER PLATED COPPER ALLOY.

### HCMS-271X

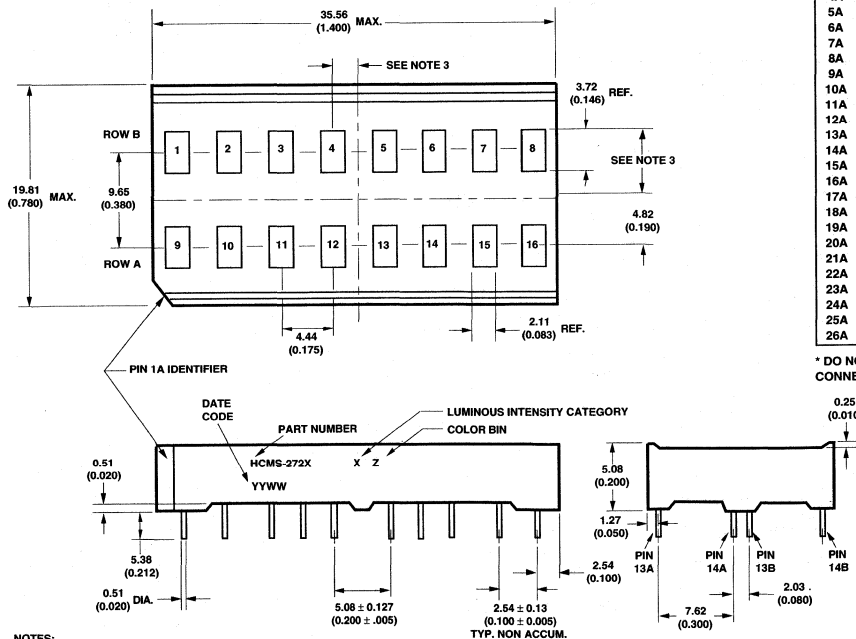

- NOTES:
1. DIMENSIONS ARE IN MILLIMETRES/INCHES.
  2. UNLESS OTHERWISE SPECIFIED, TOLERANCE IS ± 0.38MM (0.015").
  3. CHARACTERS ARE POSITIONED WITH RESPECT TO LEADS WITHIN ± 0.13MM (0.005").
  4. LEAD MATERIAL IS SOLDER PLATED COPPER ALLOY.

### HCMS-272X

PIN	FUNCTION	PIN	FUNCTION
1	NO PIN	14	DATA OUT
2	COLUMN 2	15	V <sub>B</sub> (5-8)
3	NO PIN	16	NO PIN
4	COLUMN 4	17	CLOCK
5	NO PIN	18	GROUND
6	INT. CONNECT*	19	NO PIN
7	NO PIN	20	NO PIN
8	COLUMN 1	21	INT. CONNECT*
9	NO PIN	22	V <sub>B</sub> (1-4)
10	COLUMN 3	23	V <sub>DD</sub>
11	NO PIN	24	NO PIN
12	COLUMN 5	25	GROUND
13	INT. CONNECT*	26	DATA IN

\* DO NOT CONNECT OR USE.

PIN	FUNCTION	PIN	FUNCTION
1A	NO PIN	1B	NO PIN
2A	COLUMN 2	2B	COLUMN 2
3A	NO PIN	3B	NO PIN
4A	COLUMN 4	4B	COLUMN 4
5A	NO PIN	5B	NO PIN
6A	INT. CONNECT*	6B	INT. CONNECT*
7A	NO PIN	7B	NO PIN
8A	COLUMN 1	8B	COLUMN 1
9A	NO PIN	9B	NO PIN
10A	COLUMN 3	10B	COLUMN 3
11A	NO PIN	11B	NO PIN
12A	COLUMN 5	12B	COLUMN 5
13A	INT. CONNECT*	13B	INT. CONNECT*
14A	DATA OUT	14B	DATA OUT
15A	V <sub>B</sub> (13-16)	15B	V <sub>B</sub> (5-8)
16A	NO PIN	16B	NO PIN
17A	CLOCK	17B	CLOCK
18A	GROUND	18B	GROUND
19A	NO PIN	19B	NO PIN
20A	NO PIN	20B	NO PIN
21A	INT. CONNECT*	21B	INT. CONNECT*
22A	V <sub>B</sub> (9-12)	22B	V <sub>B</sub> (1-4)
23A	V <sub>DD</sub>	23B	V <sub>DD</sub>
24A	NO PIN	24B	NO PIN
25A	GROUND	25B	GROUND
26A	DATA IN	26B	DATA IN

\* DO NOT CONNECT OR USE INTERNAL CONNECTION PINS.

## Absolute Maximum Ratings

Supply Voltage $V_{DD}$ to Ground .....	-0.3 V to 7.0 V
Data Input, Clock, Data Output, $V_B$ .....	-0.3 V to $V_{DD}$
Column Input Voltage, $V_{COL}$ .....	-0.3 V to $V_{DD}$
Free Air Operating Temperature, $T_A$ .....	-40°C to +85°C
Storage Temperature, $T_S$ .....	-55°C to +100°C
Maximum Allowable Package Power Dissipation, $P_D$ at 55°C <sup>[1,2]</sup>	
HCMS-270X .....	0.837 W
HCMS-271X .....	1.674 W
HCMS-272X (per 8 character row) .....	1.674 W
(total per package) .....	3.348 W
Maximum Solder Temperature	
1.59 mm (0.063") Below Seating Plane, $t < 5$ sec .....	260°C
ESD Protection @ 1.5 k $\Omega$ , 100 pF .....	$V_Z = 4$ kV (each pin)

### Notes:

- Maximum allowable power dissipation is derived from  $V_{DD} = 5.25$  V and  $V_B = 2.4$  V,  $V_{COL} = 3.5$  V, 20 LEDs illuminated per character, 20% on-time duty factor.
- See Figure 1 for power derating. Thermal resistance from device  $V_{DD}$  pin(s) to ambient through the PC board mounting assembly is assumed to be  $R_{\theta_{PCA}} \leq 35^\circ\text{C/W}$  per device for the HSMS-270X,  $\leq 17.5^\circ\text{C/W}$  per device for the HCMS-271X, and  $\leq 17.5^\circ\text{C/W}$  per row for the HCMS-272X.

## Recommended Operating Conditions, $T_A = -40^\circ\text{C}$ to $+85^\circ\text{C}$

Description	Symbol	Minimum	Nominal	Maximum	Unit
Supply Voltage	$V_{DD}$	4.75	5.0	5.25	V
Data Out Current, Low State	$I_{OL}$			1.6	mA
Data Out Current, High State	$I_{OH}$			-0.5	mA
Column Input Voltage	$V_{COL}$	2.75	3.0	3.5	V
Setup Time	$t_{SETUP}$	10			ns
Hold Time	$t_{HOLD}$	25			ns
Clock Pulse Width High	$t_{WH(CLOCK)}$	50			ns
Clock Pulse Width Low	$t_{WL(CLOCK)}$	50			ns
Clock High to Low Transition	$t_{THL}$			200	ns
Clock Frequency	$f_{CLOCK}$			5	MHZ

## Electrical Characteristics, $-40^\circ\text{C}$ to $+85^\circ\text{C}$

Parameter	Symbol	Test Conditions	Min.	Typ. <sup>[1]</sup>	Max.	Unit
Supply Current, Dynamic <sup>[2]</sup>	$I_{DDD}$	$V_{DD} = 5.25$ V $f_{CLOCK} = 5$ MHz $V_B = 0.4$ V				mA
HCMS-270X				6.2	7.8	
HCMS-271X				12.4	15.6	
HCMS-272X (per row)				15.6	15.6	
Supply Current, Static <sup>[3]</sup>	$I_{DDSoFF}$	$V_{DD} = 5.25$ V $V_B = 0.4$ V				mA
HCMS-270X				1.8	2.6	
HCMS-271X				3.6	5.2	
HCMS-272X (per row)	3.6	5.2				
	$I_{DDSoN}$	$V_{DD} = 5.25$ V $V_B = 2.4$ V				
HCMS-270X				2.2	6.0	
HCMS-271X				4.4	12.0	
HCMS-272X (per row)	4.4	12.0				

### Electrical Characteristics, -40°C to +85°C (cont'd.)

Parameter	Symbol	Test Conditions	Min.	Typ. <sup>[1]</sup>	Max.	Unit
Column Input Current HCMS-270X HCMS-271X HCMS-272X (per row)	$I_{COL}$	$V_{DD} = 5.25$ $V_{COL} = 3.5$ V $V_B = 2.4$ V		335 670 670	410 820 820	mA
Input Logic High: Data, $V_B$ , Clock	$V_{IH}$	$V_{DD} = 4.75$ V	2.0			V
Input Logic Low: Data, $V_B$ , Clock	$V_{IL}$	$V_{DD} = 5.25$ V			0.8	V
Input Current: Data Clock HCMS-270X HCMS-271X HCMS-272X (per row) $V_B$ HCMS-270X HCMS-271X HCMS-272X (per row)	$I_I$	$V_{DD} = 5.25$ V $0 < V_I < 5.25$ V	-10		+1	$\mu$ A
		$V_{DD} = 5.25$ V $0 < V_I < 5.25$ V	-10 -20 -20		+1	
		$V_{DD} = 5.25$ V $0 < V_B < 5.25$ V	-40 -80 -80		0	
Data Out Voltage	$V_{OH}$	$V_{DD} = 4.75$ V $I_{OH} = -0.5$ mA $I_{COL} = 0$ mA	2.4	4.2		V
	$V_{OL}$	$V_{DD} = 5.25$ V $I_{OH} = 1.6$ mA $I_{COL} = 0$ mA		0.2	0.4	
Power Dissipation <sup>[4]</sup> Per Package HCMS-270X HCMS-271X HCMS-272X (per row)	$P_D$	$V_{DD} = 5.0$ V $V_{COL} = 3.5$ V 17.5% DF $V_B = 2.4$ V 15 LEDs ON Per Character		451 902 902		mW
Thermal Resistance <sup>[5]</sup> IC Junction-to-Pin ( $V_{DD}$ ) HCMS-270X HCMS-271X HCMS-272X (per row)	$R\theta_{J-PIN}$			50		$^{\circ}$ C/W
				25		
				25		

#### Notes:

- All typical values at  $V_{DD} = 5.0$  V,  $T_A = 25^{\circ}$ C.
- $I_{DD}$  Dynamic is the IC current while clocking column data through the on-board shift register at a clock frequency of 5 MHz.
- $I_{DD}$  Static is the IC current after column data is loaded and not being clocked through the on-board shift register.
- Four, eight, or sixteen characters are illuminated with a typical ASCII character composed of 15 dots per character.
- The IC junction temperature  $T_J(IC)$ , is:

$$T_J(IC) = (P_D)(R\theta_{J-PIN} + R\theta_{PC-A}) + T_A$$

Where:  $P_D$  is the total power into the display for HCMS-270X and HCMS-271X, and the total power into one row of an HCMS-272X display.

$$P_D = P(I_{DDson}) + P(I_{COL})$$

$$P(I_{DDson}) = I_{DDson} * V_{DD}$$

$$P(I_{COL}) = 5 * I_{COL} * V_{COL} * n / 35 * DF$$

$n$  = Quantity of LED dots illuminated per character.

DF = LED on-time duty factor.

The IC junction temperature rise above the temperature of the  $V_{DD}$  pin(s),  $\Delta T_J(IC)$ , is:

$$\Delta T_J(IC) = (P_D)(R\theta_{J-PIN})$$

The IC junction temperature,  $T_J(IC)$ , must not exceed +125°C.

**Optical Characteristics at  $T_A = 25^\circ\text{C}$** **Standard Red HCMS-2700/-2710/-2720**

Description	Test Conditions	Symbol	Min.	Typ.	Unit
Peak Luminous Intensity per LED (Digit Average) <sup>[1,5]</sup>	$V_{DD} = 5.0\text{ V}$ , $V_{COL} = 3.5\text{ V}$ $V_B = 2.4\text{ V}$ , $T_i = 25^\circ\text{C}$ <sup>[3]</sup>	$I_v$	105	200	$\mu\text{cd}$
Dominant Wavelength <sup>[4]</sup>		$\lambda_d$		640	nm
Peak Wavelength		$\lambda_{PEAK}$		65	nm

**Yellow HCMS-2701/-2711/-2721**

Description	Test Conditions	Symbol	Min.	Typ.	Unit
Peak Luminous Intensity per LED (Digit Average) <sup>[1,5]</sup>	$V_{DD} = 5.0\text{ V}$ , $V_{COL} = 3.5\text{ V}$ $V_B = 2.4\text{ V}$ , $T_i = 25^\circ\text{C}$ <sup>[3]</sup>	$I_v$	400	750	$\mu\text{cd}$
Dominant Wavelength <sup>[2,4]</sup>		$\lambda_d$		585	nm
Peak Wavelength		$\lambda_{PEAK}$		583	nm

**High Efficiency Red HCMS-2702/-2712/-2722**

Description	Test Conditions	Symbol	Min.	Typ.	Unit
Peak Luminous Intensity per LED (Digit Average) <sup>[1,5]</sup>	$V_{DD} = 5.0\text{ V}$ , $V_{COL} = 3.5\text{ V}$ $V_B = 2.4\text{ V}$ , $T_i = 25^\circ\text{C}$ <sup>[3]</sup>	$I_v$	400	1430	$\mu\text{cd}$
Dominant Wavelength <sup>[4]</sup>		$\lambda_d$		625	nm
Peak Wavelength		$\lambda_{PEAK}$		635	nm

**High Performance Green HCMS-2703/-2713/-2723**

Description	Test Conditions	Symbol	Min.	Typ.	Unit
Peak Luminous Intensity per LED (Digit Average) <sup>[1,5]</sup>	$V_{DD} = 5.0\text{ V}$ , $V_{COL} = 3.5\text{ V}$ $V_B = 2.4\text{ V}$ , $T_i = 25^\circ\text{C}$ <sup>[3]</sup>	$I_v$	400	1550	$\mu\text{cd}$
Dominant Wavelength <sup>[2,4]</sup>		$\lambda_d$		574	nm
Peak Wavelength		$\lambda_{PEAK}$		568	nm

**Orange HCMS-2704/-2714/-2724**

Description	Test Conditions	Symbol	Min.	Typ.	Unit
Peak Luminous Intensity per LED (Digit Average) <sup>[1,5]</sup>	$V_{DD} = 5.0\text{ V}$ , $V_{COL} = 3.5\text{ V}$ $V_B = 2.4\text{ V}$ , $T_i = 25^\circ\text{C}$ <sup>[3]</sup>	$I_v$	400	1400	$\mu\text{cd}$
Dominant Wavelength <sup>[4]</sup>		$\lambda_d$		602	nm
Peak Wavelength		$\lambda_{PEAK}$		600	nm

**Notes:**

1. These displays are categorized for luminous intensity with the intensity category designated by a letter code located on the side of the display package.
2. Yellow and high performance green devices are categorized for color with the color category designated by a number code on the side of the display package.
3.  $T_i$  refers to the initial device temperature immediately prior to the light measurement.
4. Dominant wavelength,  $\lambda_d$ , is derived from the CIE chromaticity diagram and is that single wavelength which defines the LED color.
5. The luminous sterance of the individual LED pixels may be calculated using the following equations:

$$L_v(\text{cd/m}^2) = I_v(\text{Candela}) * \text{DF} / \text{A}(\text{Meter}^2)$$

$$L_v(\text{Footlamberts}) = \pi I_v(\text{Candela}) * \text{DF} / \text{A}(\text{Foot}^2)$$

Where: A = LED pixel area =  $3.32 \times 10^{-8} \text{ m}^2$  or  $3.57 \times 10^{-7} \text{ ft}^2$   
DF = LED on-time duty factor.

## Switching Characteristics, $T_A = -40^\circ\text{C}$ to $+85^\circ\text{C}$

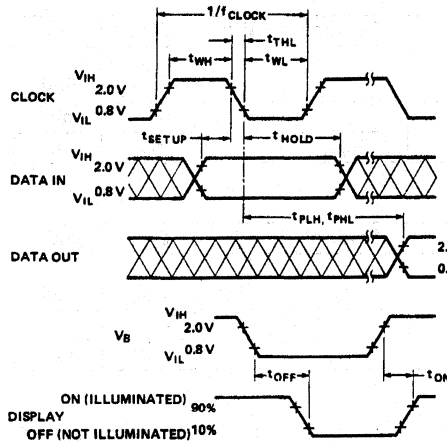

Parameter	Condition	Typ.	Max.	Units
$f_{\text{CLOCK}}$ CLOCK Rate			5	MHz
$t_{\text{PLH}}$ , $t_{\text{PHL}}$ Propagation Delay CLOCK to DATA OUT	$C_L = 15 \text{ pF}$ $R_L = 2.4 \text{ k}\Omega$		105	ns
$t_{\text{OFF}}$ $V_B$ (0.4 V) to Display OFF		4	5	$\mu\text{s}$
$t_{\text{ON}}$ $V_B$ (2.4 V) to Display ON		1	2	

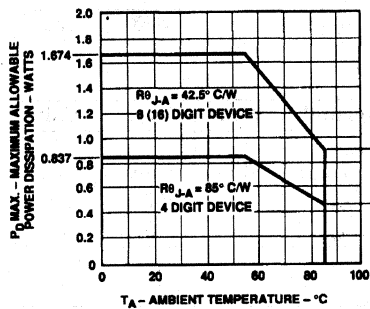

Figure 1. Maximum Allowable Power Dissipation vs. Ambient Temperature as a Function of Thermal Resistance IC Junction-to-Ambient,  $R_{\theta J-A}$ . Operation at  $85^\circ\text{C}$  Assumes a Thermal Resistance for the Printed Circuit Board of  $R_{\theta PC-A} = 35^\circ\text{C/W}$  Per Device for the HCMS-270X,  $17.5^\circ\text{C/W}$  Per Device for the HCMS-271X, and  $17.5^\circ\text{C/W}$  Per Row for the HCMS-272X.

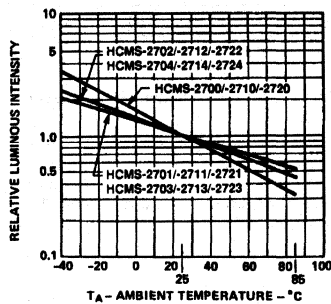

Figure 2. Relative Luminous Intensity vs. Display Pin Temperature.

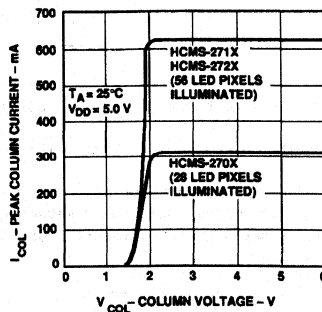

Figure 3. Peak Column Current vs. Column Voltage.

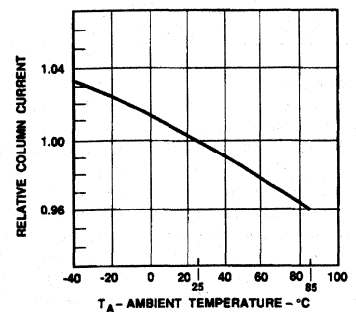

Figure 4. Relative Column Current,  $I_{\text{COL}}$ , vs. Ambient Temperature.

## Electrical Description

Each display device contains four or eight 5x7 LED dot matrix characters and two or four CMOS integrated circuits, as shown in Figure 5. The CMOS integrated circuits form an on-board 28 bit or 56 bit serial-in-parallel-out shift register that will accept standard TTL logic levels. The Data Input pin is connected to bit position 1 and the Data Output pin is connected to bit position 28 (56). The shift register outputs control constant current sinking LED row drivers. The nominal current sink per LED driver is 11 mA. A logic 1 stored in the shift register enables the corresponding LED row driver and a logic 0 stored in the shift register disables the corresponding LED row driver.

The electrical configuration of these CMOS IC alphanumeric displays allows for an effective interface to a display controller circuit that supplies decoded character information. The row data for a given column (one 7 bit byte per character) is loaded (bit serial) into the on-board 28 (56) bit shift register with high to low transitions of the Clock input. To load decoded character information into the display, column data for character 4 (8) is loaded first and the column data for character 1 is loaded last in the following manner. The 7 data bits for column 1, character 4 (8), are loaded into the on-board shift register. Next, the 7 data bits for column 1, character 3 (7), are loaded into the shift register, shifting the character 4 (8) data bits over one character position.

This process is repeated for the other 2 (6) characters until all 28 (56) bits of column data (four or eight 7 bit bytes of character column data) are loaded into the on-board shift register. Then the column 1 input,  $V_{COL}$ , pin 1, is energized to illuminate column 1 in all 4 (8) characters. This process is repeated for columns 2, 3, 4, and 5. All of the  $V_{COL}$  inputs should be at logic low to insure the display is off when loading data. The display will be blanked when the blanking input  $V_B$  is at logic low regardless of the outputs of the shift register or whether one of the  $V_{COL}$  inputs is energized.

Refer to Application Note 1016 *Using the HDSP-2000 Alphanumeric Display Family* for drive circuit information.

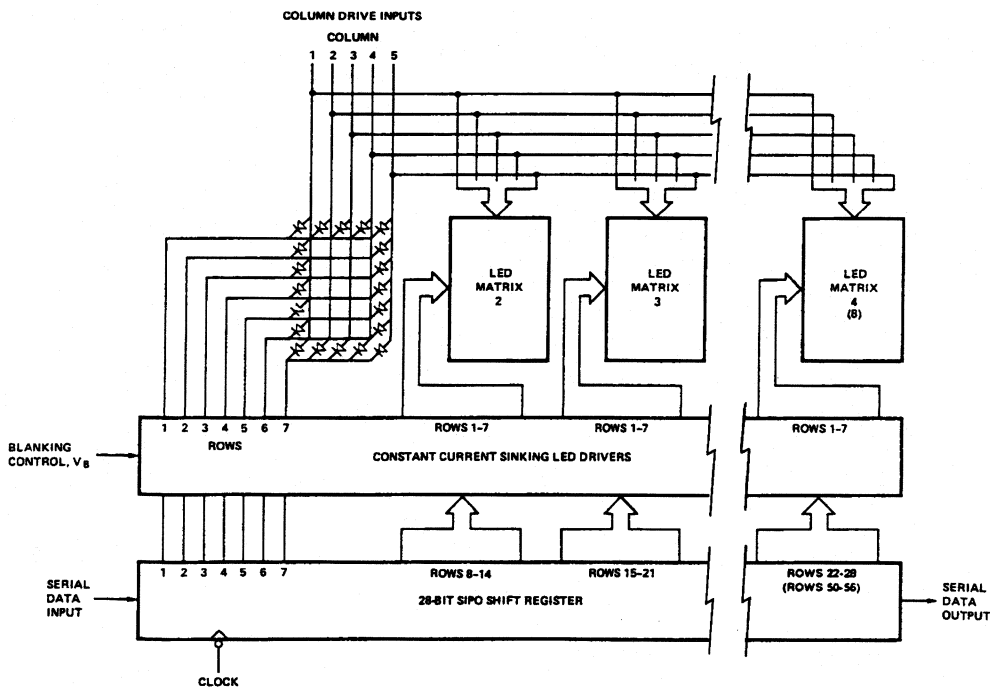

Figure 5. Block Diagram of an HCMS-27XX Series LED Alphanumeric Display.

### **ESD Susceptibility**

The HCMS-27XX series displays have an ESD susceptibility ratings of CLASS 3 per DOD-STD-1686 and CLASS B per MIL-STD-883C. It is recommended that normal CMOS handling precautions be observed with these devices.

### **Soldering and Post Solder Cleaning**

For information on soldering and post-solder cleaning of LED Displays, see Application Note 1027: *Soldering LED Components*.

### **Contrast Enhancement**

When used with the proper contrast enhancement filters, the HCMS-27XX series displays are readable in bright ambients. For information on contrast enhancement, refer to Application Note 1015 *Contrast Enhancement Techniques for LED Displays*.



# High Performance CMOS 5 x 7 Alphanumeric Displays

## Technical Data

### HCMS-29XX Series

#### Features

- Easy to Use
- Interfaces Directly with Microprocessors
- 0.15" Character Height in 4, 8, and 16 (2x8) Character Packages
- 0.20" Character Height in 4 and 8 Character Packages
- Rugged X- and Y-Stackable Package
- Serial Input
- Convenient Brightness Controls
- Wave Solderable
- Offered in Five Colors
- Low Power CMOS Technology
- TTL Compatible

#### Description

The HCMS-29XX series are high performance, easy to use dot matrix displays driven by on-board CMOS ICs. Each display can be directly interfaced with a microprocessor, thus eliminating the need for cumbersome interface components. The serial IC interface allows higher character count information displays with a minimum of data lines. A variety of colors, font heights, and character counts gives designers a wide range of product choices for their specific applications and the easy to read 5 x 7 pixel format allows the display of uppercase, lower case, Katakana, and custom user-defined characters. These displays are stackable in the x- and y-directions, making them ideal for high character count displays.

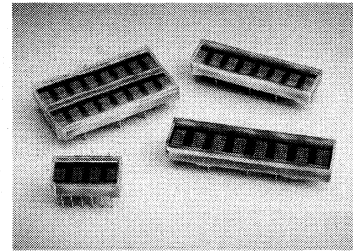

ALPHANUMERIC  
DISPLAYS

#### Applications

- Telecommunications Equipment
- Portable Data Entry Devices
- Computer Peripherals
- Medical Equipment
- Test Equipment
- Business Machines
- Avionics
- Industrial Controls

#### Device Selection Guide

Description	AlGaAs HCMS-	HER HCMS-	Orange HCMS-	Yellow HCMS-	Green HCMS-	Package Drawing
1 x 4 0.15" Character	2905	2902	2904	2901	2903	A
1 x 8 0.15" Character	2915	2912	2914	2911	2913	B
2 x 8 0.15" Character	2925	2922	2924	2921	2923	C
1 x 4 0.20" Character	2965	2962	2964	2961	2963	D
1 x 8 0.20" Character	2975	2972	2974	2971	2973	E

**ESD WARNING: STANDARD CMOS HANDLING PRECAUTIONS SHOULD BE OBSERVED TO AVOID STATIC DISCHARGE.**

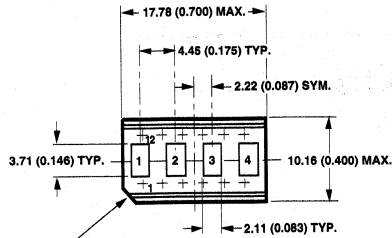

PIN FUNCTION ASSIGNMENT TABLE

PIN #	FUNCTION
1	DATA OUT
2	OSC
3	V LED
4	DATA IN
5	RS
6	CLK
7	CE
8	BLANK
9	GND
10	SEL
11	V LOGIC
12	RESET

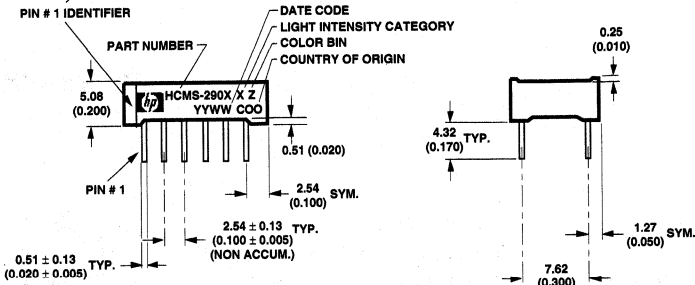

- NOTES:  
 1. DIMENSIONS ARE IN mm (INCHES).  
 2. UNLESS OTHERWISE SPECIFIED, TOLERANCE ON DIMENSIONS IS  $\pm 0.38$  mm (0.015 INCH).  
 3. LEAD MATERIAL: SOLDER PLATED COPPER ALLOY.

## HCMS-290X

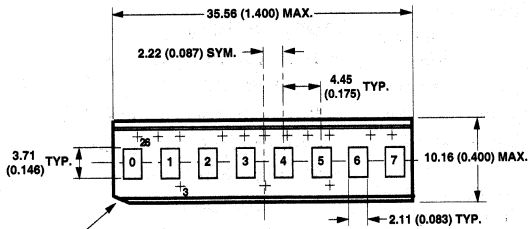

PIN FUNCTION ASSIGNMENT TABLE

PIN #	FUNCTION
1	NO PIN
2	NO PIN
3	V LED
4	NO PIN
5	NO PIN
6	NO PIN
7	GND LED
8	NO PIN
9	NO PIN
10	V LED
11	NO PIN
12	NO PIN
13	NO PIN
14	DATA IN
15	RS
16	NO PIN
17	CLOCK
18	CE
19	BLANK
20	GND LOGIC
21	SEL
22	V LOGIC
23	NO PIN
24	RESET
25	OSC
26	DATA OUT

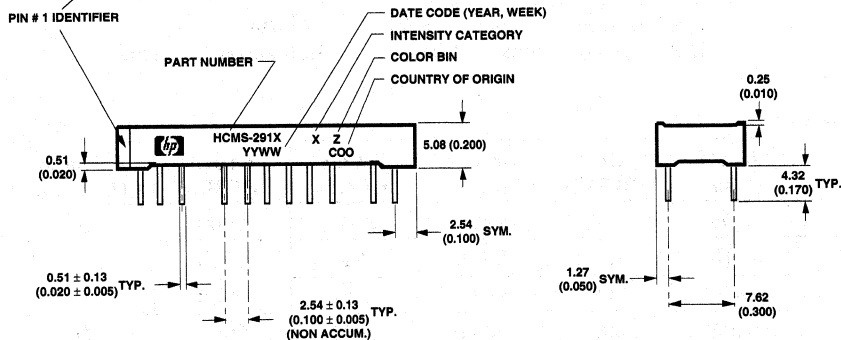

- NOTES:  
 1. DIMENSIONS ARE IN mm (INCHES).  
 2. UNLESS OTHERWISE SPECIFIED, TOLERANCE ON DIMENSIONS IS  $\pm 0.38$  mm (0.015 INCH).  
 3. LEAD MATERIAL: SOLDER PLATED COPPER ALLOY.

## HCMS-291X

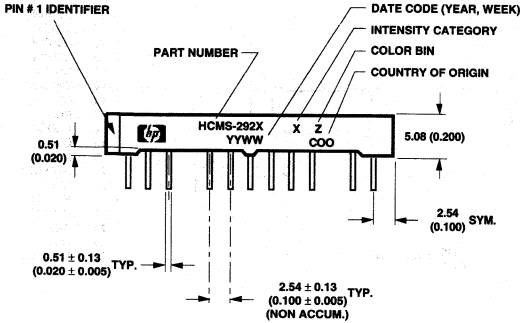
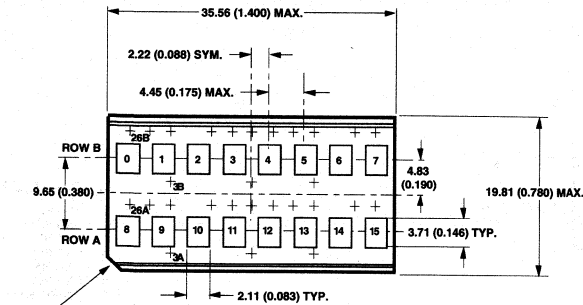

- NOTES:**  
 1. DIMENSIONS ARE IN mm (INCHES).  
 2. UNLESS OTHERWISE SPECIFIED, TOLERANCE ON DIMENSIONS IS ± 0.38 mm (0.015 INCH).  
 3. LEAD MATERIAL: SOLDER PLATED COPPER ALLOY.

PIN FUNCTION ASSIGNMENT TABLE

PIN #	FUNCTION	PIN #	FUNCTION
1A	NO PIN	1B	NO PIN
2A	NO PIN	2B	NO PIN
3A	V LED	3B	V LED
4A	NO PIN	4B	NO PIN
5A	NO PIN	5B	NO PIN
6A	NO PIN	6B	NO PIN
7A	GND LED	7B	GND LED
8A	NO PIN	8B	NO PIN
9A	NO PIN	9B	NO PIN
10A	V LED	10B	V LED
11A	NO PIN	11B	NO PIN
12A	NO PIN	12B	NO PIN
13A	NO PIN	13B	NO PIN
14A	DATA IN	14B	DATA IN
15A	RS	15B	RS
16A	NO PIN	16B	NO PIN
17A	CLOCK	17B	CLOCK
18A	CE	18B	CE
19A	BLANK	19B	BLANK
20A	GND LOGIC	20B	GND LOGIC
21A	SEL	21B	SEL
22A	V LOGIC	22B	V LOGIC
23A	NO PIN	23B	NO PIN
24A	RESET	24B	RESET
25A	OSC	25B	OSC
26A	DATA OUT	26B	DATA OUT

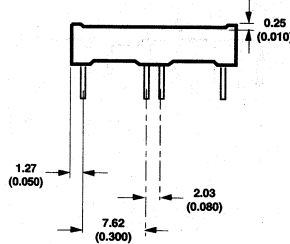

## HCMS-292X

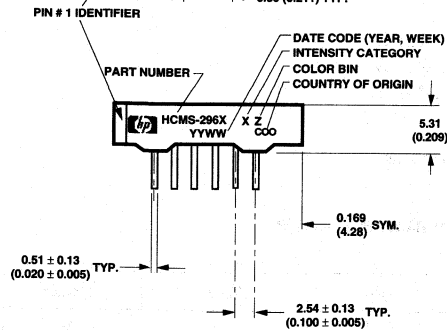
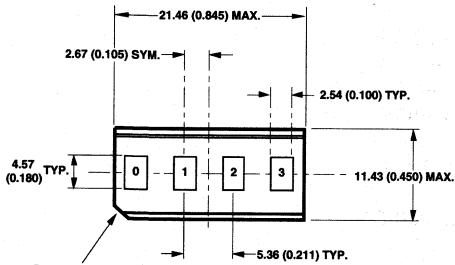

- NOTES:**  
 1. DIMENSIONS ARE IN mm (INCHES).  
 2. UNLESS OTHERWISE SPECIFIED, THE TOLERANCE ON DIMENSIONS IS ± 0.38 mm (0.015 INCH).  
 3. LEAD MATERIAL: SOLDER PLATED COPPER ALLOY.

PIN FUNCTION ASSIGNMENT TABLE

PIN #	FUNCTION
1	DATA OUT
2	OSC
3	V LED
4	DATA IN
5	RS
6	CLK
7	CE
8	BLANK
9	GND
10	SEL
11	V LOGIC
12	RESET

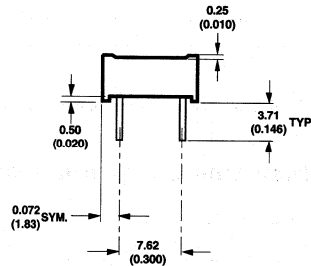

## HCMS-296X

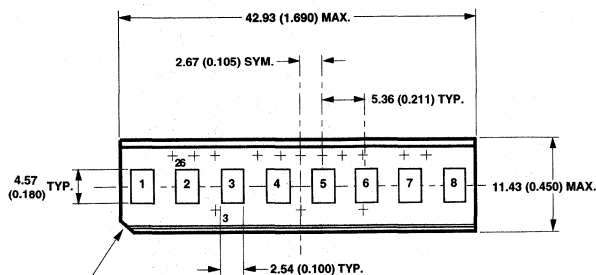

PIN # 1 IDENTIFIER

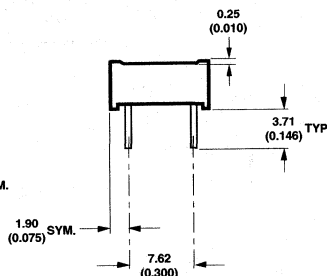
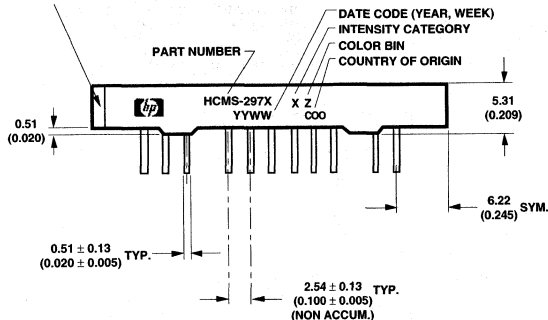

PIN #	FUNCTION
1	NO PIN
2	NO PIN
3	V LED
4	NO PIN
5	NO PIN
6	NO PIN
7	GND LED
8	NO PIN
9	NO PIN
10	V LED
11	NO PIN
12	NO PIN
13	NO PIN
14	DATA IN
15	RS
16	NO PIN
17	CLOCK
18	CE
19	BLANK
20	GND LOGIC
21	SEL
22	V LOGIC
23	NO PIN
24	RESET
25	OSC
26	DATA OUT

- NOTES:  
 1. DIMENSIONS ARE IN mm (INCHES).  
 2. UNLESS OTHERWISE SPECIFIED, TOLERANCE ON DIMENSIONS IS  $\pm 0.38$  mm (0.015 INCH).  
 3. LEAD MATERIAL: SOLDER PLATED COPPER ALLOY.

## HCMS-297X

### Absolute Maximum Ratings

Logic Supply Voltage, $V_{\text{LOGIC}}$ to $\text{GND}_{\text{LOGIC}}$ .....	-0.3 V to 7.0 V
LED Supply Voltage, $V_{\text{LED}}$ to $\text{GND}_{\text{LED}}$ .....	-0.3 V to 5.5 V
Input Voltage, Any Pin to GND .....	-0.3 V to $V_{\text{LOGIC}} + 0.3$ V
Free Air Operating Temperature Range $T_A^{[1]}$ .....	-40°C to +85°C
Relative Humidity (non-condensing) .....	85%
Storage Temperature, $T_S$ .....	-55°C to 100°C
Maximum Solder Temperature	
1.59 mm (0.063 in.) Below Seating Plane, $t < 5$ sec .....	260°C
ESD Protection @ 1.5 k $\Omega$ , 100 pF (each pin) .....	2 KV
TOTAL Package Power Dissipation at $T_A = 25^\circ\text{C}^{[2]}$	
4 character .....	1.2 W
8 character .....	2.4 W
16 character .....	4.8 W

#### Notes:

1. For operation in high ambient temperatures, see Appendix A, Thermal Considerations.

### Recommended Operating Conditions over Temperature Range (-40°C to +85°C)

Parameter	Symbol	Min.	Typ.	Max.	Units
Logic Supply Voltage	$V_{\text{LOGIC}}$	3.0	5.0	5.5	V
LED Supply Voltage	$V_{\text{LED}}$	4.0	5.0	5.5	V
$\text{GND}_{\text{LED}}$ to $\text{GND}_{\text{LOGIC}}$	-	-0.3	0	+0.3	V

### Electrical Characteristics over Operating Temperature Range (-40°C to +85°C)

Parameter	Symbol	T <sub>A</sub> = 25°C		-40°C < T <sub>A</sub> < 85°C		Units	Test Conditions
		V <sub>LOGIC</sub> = 5.0 V		3.0 V < V <sub>LOGIC</sub> < 5.5 V			
		Typ.	Max.	Min.	Max.		
Input Leakage Current HCMS-290X/296X (4 char) HCMS-291X/297X (8 char) HCMS-292X (16 char)	I <sub>I</sub>		+7.5 +15 +15	-2.5 -5.0 -5.0	+50 +100 +100	μA	V <sub>IN</sub> = 0 V to V <sub>LOGIC</sub>
I <sub>LOGIC</sub> OPERATING HCMS-290X/296X (4 char) HCMS-291X/297X (8 char) HCMS-292X (16 char)	I <sub>LOGIC</sub> (OPT)	0.4 0.8 0.8	2.5 5 5		5 10 10	mA	V <sub>IN</sub> = V <sub>LOGIC</sub>
I <sub>LOGIC</sub> SLEEP <sup>[1]</sup> HCMS-290X/296X (4 char) HCMS-291X/297X (8 char) HCMS-292X (16 char)	I <sub>LOGIC</sub> (SLP)	5 10 10	15 30 30		25 50 50	μA	V <sub>IN</sub> = V <sub>LOGIC</sub>
I <sub>LED</sub> BLANK HCMS-290X/296X (4 char) HCMS-291X/297X (8 char) HCMS-292X (16 char)	I <sub>LED</sub> (BL)	0.4 0.8 0.8	1.8 3.5 3.5		2.5 5 5	mA	BL = 0 V
I <sub>LED</sub> SLEEP <sup>[1]</sup> HCMS-290X/296X (4 char) HCMS-291X/297X (8 char) HCMS-292X (16 char)	I <sub>LED</sub> (SLP)	1 2 2	3 6 6		50 100 100	μA	
Peak Pixel Current <sup>[2]</sup> HCMS-29X5 (AlGaAs) HCMS-29XX (Other Colors)	I <sub>PIXEL</sub>	15.4 14.0	17.1 15.9		18.7 17.1	mA mA	V <sub>LED</sub> = 5.5 V All pixels ON, Average value per pixel
HIGH level input voltage	V <sub>Ih</sub>			2.0		V	4.5 V < V <sub>LOGIC</sub> < 5.5 V
				0.8 V <sub>LOGIC</sub>		V	3.0 V < V <sub>LOGIC</sub> < 4.5 V
LOW level input voltage	V <sub>Il</sub>				1.1	V	4.5 V < V <sub>LOGIC</sub> < 5.5 V
					0.2 V <sub>LOGIC</sub>	V	3.0 V < V <sub>LOGIC</sub> < 4.5 V
HIGH level output voltage	V <sub>Oh</sub>			2.4		V	V <sub>LOGIC</sub> = 4.5 V, I <sub>oh</sub> = -40 μA
				0.8 V <sub>LOGIC</sub>		V	3.0 V < V <sub>LOGIC</sub> < 4.5 V
LOW level output voltage	V <sub>Ol</sub>				0.4	V	V <sub>LOGIC</sub> = 5.5 V, I <sub>ol</sub> = 1.6 mA <sup>[3]</sup>
					0.2 V <sub>LOGIC</sub>	V	3.0 V < V <sub>LOGIC</sub> < 4.5 V
Thermal Resistance	Rθ <sub>J-P</sub>	70				°C/W	IC junction to pin

#### Notes:

- In SLEEP mode, the internal oscillator and reference current for LED drivers are off.
- Average peak pixel current is measured at the maximum drive current set by Control Register 0. Individual pixels may exceed this value.
- For the Oscillator Output, I<sub>ol</sub> = 40 μA.

## Optical Characteristics at 25°C<sup>[1]</sup>

$V_{LED} = 5.0$  V, 50% Peak Current, 100% Pulse Width

Display Color	Part Number	Luminous Intensity per LED <sup>[2]</sup> Character Average ( $\mu$ cd)		Peak Wavelength $\lambda_{Peak}$ (nm)	Dominant Wavelength $\lambda_d$ <sup>[3]</sup> (nm)
		Min.	Typ.	Typ.	Typ.
AlGaAs Red	HCMS-29X5	95	230	645	637
High Efficiency Red	HCMS-29X2	29	64	635	626
Orange	HCMS-29X4	29	64	600	602
Yellow	HCMS-29X1	29	64	583	585
Green	HCMS-29X3	57	114	568	574

### Notes:

1. Refers to the initial case temperature of the device immediately prior to measurement.
2. Measured with all LEDs illuminated.
3. Dominant wavelength,  $\lambda_d$ , is derived from the CIE chromaticity diagram and represents the single wavelength which defines the perceived LED color.

## Electrical Description

Pin Function	Description
RESET ( $\overline{RST}$ )	Sets Control Register bits to logic low. The Dot Register contents are unaffected by the Reset pin. (logic low = reset; logic high = normal operation).
DATA IN ( $D_{IN}$ )	Serial Data input for Dot or Control Register data. Data is entered on the rising edge of the Clock input.
DATA OUT ( $D_{OUT}$ )	Serial Data output for Dot or Control Register data. This pin is used for cascading multiple displays.
CLOCK (CLK)	Clock input for writing Dot or Control Register data. When $\overline{Chip\ Enable}$ is logic low, data is entered on the rising Clock edge.
REGISTER SELECT (RS)	Selects Dot Register (RS = logic low) or Control Register (RS = logic high) as the destination for serial data entry. The logic level of RS is latched on the falling edge of the $\overline{Chip\ Enable}$ input.
$\overline{CHIP\ ENABLE}$ ( $\overline{CE}$ )	This input must be a logic low to write data to the display. When $\overline{CE}$ returns to logic high and CLK is logic low, data is latched to either the LED output drivers or a Control Register.
OSCILLATOR SELECT (SEL)	Selects either an internal or external display oscillator source. (logic low = External Display Oscillator; logic high = Internal Display Oscillator).
OSCILLATOR (OSC)	Output for the Internal Display Oscillator (SEL = logic high) or input for an External Display Oscillator (SEL = logic low).
BLANK (BL)	Blanks the display when logic high. May be modulated for brightness control.
$GND_{LED}$	Ground for LED drivers.
$GND_{LOGIC}$	Ground for logic.
$V_{LED}$	Positive supply for LED drivers.
$V_{LOGIC}$	Positive supply for logic.

## AC Timing Characteristics over Temperature Range (-40°C to +85°C)

Timing Diagram Ref. Number	Description	Symbol	4.5 V < V <sub>LOGIC</sub> < 5.5 V		V <sub>LOGIC</sub> = 3 V		Units
			Min.	Max.	Min.	Max.	
1	Register Select Setup Time to Chip Enable	t <sub>rss</sub>	10		10		ns
2	Register Select Hold Time to Chip Enable	t <sub>rsh</sub>	10		10		ns
3	Rising Clock Edge to Falling Chip Enable Edge	t <sub>clkce</sub>	20		20		ns
4	Chip Enable Setup Time to Rising Clock Edge	t <sub>ces</sub>	35		55		ns
5	Chip Enable Hold Time to Rising Clock Edge	t <sub>ceh</sub>	20		20		ns
6	Data Setup Time to Rising Clock Edge	t <sub>ds</sub>	10		10		ns
7	Data Hold Time after Rising Clock Edge	t <sub>dh</sub>	10		10		ns
8	Rising Clock Edge to D <sub>OUT</sub> <sup>[1]</sup>	t <sub>dout</sub>	10	40	10	65	ns
9	Propagation Delay D <sub>IN</sub> to D <sub>OUT</sub> Simultaneous Mode for one IC <sup>[1,2]</sup>	t <sub>doutp</sub>		18		30	ns
10	$\overline{\text{CE}}$ Falling Edge to D <sub>OUT</sub> Valid	t <sub>cedo</sub>		25		45	ns
11	Clock High Time	t <sub>clkh</sub>	80		100		ns
12	Clock Low Time	t <sub>ckl</sub>	80		100		ns
	Reset Low Time	t <sub>rstl</sub>	50		50		ns
	Clock Frequency	F <sub>cyc</sub>		5		4	MHz
	Internal Display Oscillator Frequency	F <sub>inosc</sub>	80	210	80	210	KHz
	Internal Refresh Frequency	F <sub>rf</sub>	150	410	150	400	Hz
	External Display Oscillator Frequency Prescaler = 1 Prescaler = 8	F <sub>exosc</sub>	51.2 410	1000 8000	51.2 410	1000 8000	KHz KHz

**Notes:**

- Timing specifications increase 0.3 ns per pf of capacitive loading above 15 pF.
- This parameter is valid for Simultaneous Mode data entry of the Control Register.

## Display Overview

The HCMS-29XX series is a family of LED displays driven by on-board CMOS ICs. The LEDs are configured as 5 x 7 font characters and are driven in groups of 4 characters per IC. Each IC consists of a 160-bit shift register (the Dot Register), two 7-bit Control Words, and refresh circuitry. The Dot Register contents are mapped on a one-to-one basis to the display. Thus, an individual Dot Register bit uniquely controls a single LED.

8-character displays have two ICs that are cascaded. The Data Out line of the first IC is internally connected to the Data In line of the second IC forming a 320-bit Dot Register. The display's other control and power lines are connected directly to both ICs. In 16-character displays, each row functions as an independent 8-character display with its own 320-bit Dot Register.

## Reset

Reset initializes the Control Registers (sets all Control Register bits to logic low) and places the display in the sleep mode. The  $\overline{\text{Reset}}$  pin should be connected to the system power-on reset circuit. The Dot Registers are not cleared upon power-on or by  $\overline{\text{Reset}}$ . After power-on, the Dot Register contents are random; however,  $\overline{\text{Reset}}$  will put the display in sleep mode, thereby blanking the LEDs. The Control Register and the Control Words are cleared to all zeros by  $\overline{\text{Reset}}$ .

To operate the display after being  $\overline{\text{Reset}}$ , load the Dot Register with logic lows. Then load Control Word 0 with the desired brightness level and set the sleep mode bit to logic high.

## Dot Register

The Dot Register holds the pattern to be displayed by the

LEDs. Data is loaded into the Dot Register according to the procedure shown in Table 1 and the Write Cycle Timing Diagram.

First RS is brought low, then  $\overline{\text{CE}}$  is brought low. Next, each successive rising CLK edge will shift in the data at the  $D_{\text{IN}}$  pin. Loading a logic high will turn the corresponding LED on; a logic low turns the LED off. When all 160 bits have been loaded (or 320 bits in an 8-digit display),  $\overline{\text{CE}}$  is brought to logic high.

When CLK is next brought to logic low, new data is latched into the display dot drivers. Loading data into the Dot Register takes place while the previous data is displayed and eliminates the need to blank the display while loading data.

## Pixel Map

In a 4-character display, the 160-bits are arranged as 20

**Table 1. Register Truth Table**

Function	CLK	$\overline{\text{CE}}$	RS
Select Dot Register	Not Rising	↓	L
Load Dot Register $D_{\text{IN}} = \text{HIGH}$ LED = "ON" $D_{\text{IN}} = \text{LOW}$ LED = "OFF"	↑	L	X
Copy Data from Dot Register to Dot Latch	L	H	X
Select Control Register	Not Rising	↓	H
Load Control Register <sup>[1]</sup>	↑	L	X
Latch Data to Control Word 1 <sup>[2]</sup>	L	H	X

### Notes:

1. BIT  $D_0$  of Control Word 1 must have been previously set to Low for serial mode or High for simultaneous mode.
2. Selection of Control Word 1 or Control Word 0 is set by  $D_7$  of the Control Shift Register. The unselected control word retains its previous value.



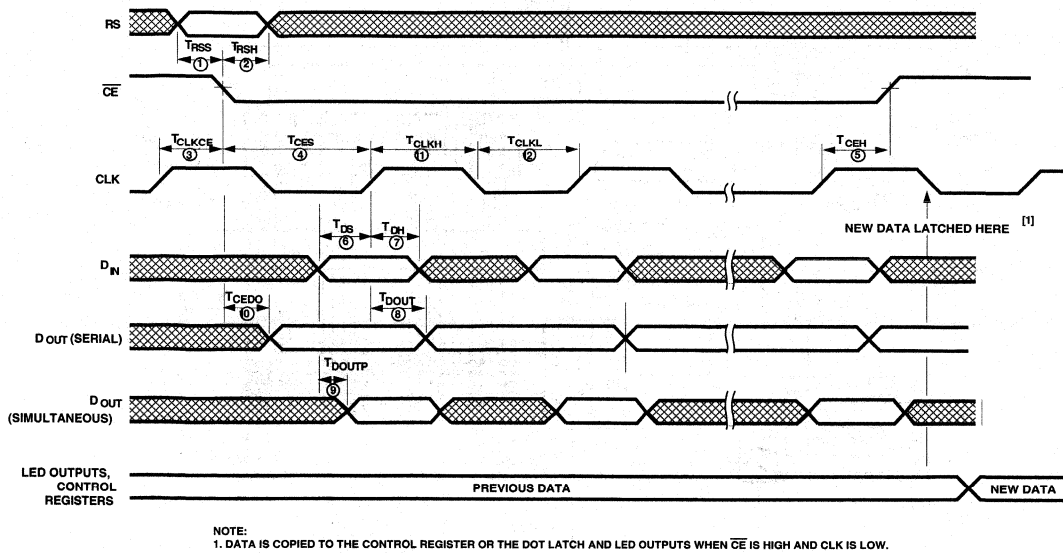

## HCMS-29XX Write Cycle Diagram

columns by 8 rows. This array can be conceptualized as four 5 x 8 dot matrix character locations, but only 7 of the 8 rows have LEDs (see Figures 1 & 2). The bottom row (row 0) is not used. Thus, latch location 0 is never displayed. Column 0 controls the left-most column. Data from Dot Latch locations 0-7 determine whether or not pixels in Column 0 are turned-on or turned-off. Therefore, the lower left pixel is turned-on when a logic high is stored in Dot Latch location 1. Characters are loaded in serially, with the left-most character being loaded first and the right-most character being loaded last. By loading one character at a time and latching the data before loading the next character, the figures will appear to scroll from right to left.

### Control Register

The Control Register allows software modification of the IC's operation and consists of two independent 7-bit control words. Bit  $D_7$  in the shift register selects one of the two 7-bit control words. Control Word 0 performs pulse width modulation brightness control, peak pixel current brightness control, and sleep mode. Control Word 1 sets serial/simultaneous data out mode, and external oscillator prescaler. Each function is independent of the others.

### Control Register Data Loading

Data is loaded into the Control Register according to the procedure shown in Table 1 and the Write Cycle Timing Diagram. First, RS is brought to logic high

and then  $\overline{CE}$  is brought to logic low. Next, each successive rising CLK edge will shift in the data on the  $D_{IN}$  pin. Finally, when 8 bits have been loaded, the  $\overline{CE}$  line is brought to logic high. When CLK goes to logic low, new data is copied into the selected control word. Loading data into the Control Register takes place while the previous control word configures the display.

### Control Word 0

Loading the Control Register with  $D_7 = \text{Logic low}$  selects Control Word 0 (see Table 2). Bits  $D_0$ - $D_3$  adjust the display brightness by pulse width modulating the LED on-time, while Bits  $D_4$ - $D_5$  adjust the display brightness by changing the peak pixel current. Bit  $D_6$  selects normal operation or sleep mode.

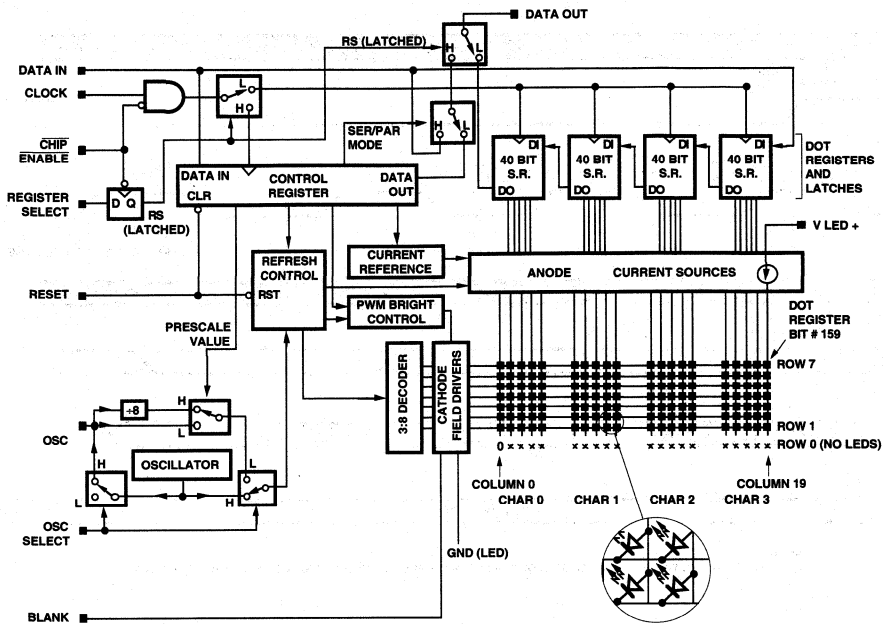

Figure 1.

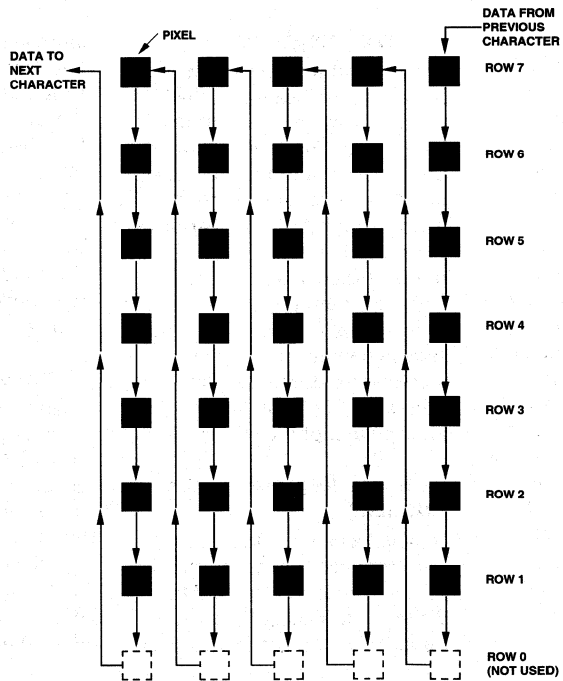

Figure 2.

Sleep mode (Control Word 0, bit  $D_6 = \text{Low}$ ) turns off the Internal Display Oscillator and the LED pixel drivers. This mode is used when the IC needs to be powered up, but does not need to be active. Current draw in sleep mode is nearly zero. Data in the Dot Register and Control Words are retained during sleep mode.

### Control Word 1

Loading the Control Register with  $D_7 = \text{logic high}$  selects Control Word 1. This Control Word performs two functions: serial/simultaneous data out mode and external oscillator prescale select (see Table 2).

### Serial/Simultaneous Data Output $D_0$

Bit  $D_0$  of control word 1 is used to switch the mode of  $D_{OUT}$  between serial and simultaneous data entry during Control Register writes. The default mode (logic low) is the serial  $D_{OUT}$  mode. In serial mode,  $D_{OUT}$  is connected to the last bit ( $D_7$ ) of the Control Shift Register.

Storing a logic high to bit  $D_0$  changes  $D_{OUT}$  to simultaneous mode which affects the Control Register only. In simultaneous mode,  $D_{OUT}$  is logically connected to  $D_{IN}$ . This arrangement allows multiple ICs to have their Control Registers written to simultaneously. For example, for  $N$  ICs in the serial mode,  $N * 8$  clock pulses are needed to load the same data in all Control Registers.

In the simultaneous mode,  $N$  ICs only need 8 clock pulses to load the same data in all Control Registers. The propagation delay from the first IC to the last is  $N * t_{DOUTP}$ .

### External Oscillator Prescaler Bit $D_1$

Bit  $D_1$  of Control Word 1 is used to scale the frequency of an external Display Oscillator. When this bit is logic low, the external Display Oscillator directly sets the internal display clock rate. When this bit is a logic high, the external oscillator is divided by 8. This scaled frequency then sets the internal display clock rate. It takes 512 cycles of the display clock (or  $8 \times 512 = 4096$  cycles of an external clock with the divide by 8 prescaler) to completely refresh the display once. Using the prescaler bit allows the designer to use a higher external oscillator frequency without extra circuitry.

This bit has no effect on the internal Display Oscillator Frequency.

### Bits $D_2$ - $D_6$

These bits must always be programmed to logic low.

### Cascaded ICs

Figure 3 shows how two ICs are connected within an HCMS-29XX display. The first IC controls the four left-most characters and the second IC controls the four right-most characters. The Dot

Registers are connected in series to form a 320-bit dot shift register. The location of pixel 0 has not changed. However, Dot Shift Register bit 0 of IC2 becomes bit 160 of the 320-bit dot shift register.

The Control Registers of the two ICs are independent of each other. This means that to adjust the display brightness the same control word must be entered into both ICs, unless the Control Registers are set to simultaneous mode.

Longer character string systems can be built by cascading multiple displays together. This is accomplished by creating a five line bus. This bus consists of  $\overline{CE}$ , RS, BL, Reset, and CLK. The display pins are connected to the corresponding bus line. Thus, all  $\overline{CE}$  pins are connected to the  $\overline{CE}$  bus line. Similarly, bus lines for RS, BL, Reset, and CLK are created. Then  $D_{IN}$  is connected to the right-most display.  $D_{OUT}$  from this display is connected to the next display. The left-most display receives its  $D_{IN}$  from the  $D_{OUT}$  of the display to its right.  $D_{OUT}$  from the left-most display is not used.

Each display may be set to use its internal oscillator, or the displays may be synchronized by setting up one display as the master and the others as slaves. The slaves are set to receive their oscillator input from the master's oscillator output.

**Table 2. Control Shift Register**

CONTROL WORD 0

L	D <sub>6</sub>	D <sub>5</sub>	D <sub>4</sub>	D <sub>3</sub>	D <sub>2</sub>	D <sub>1</sub>	D <sub>0</sub>
---	----------------	----------------	----------------	----------------	----------------	----------------	----------------

↑  
Bit D<sub>7</sub>  
Set Low  
to Select  
Control  
Word 0

PWM Brightness Control				On-Time Oscillator Cycles	Duty Factor (%)	Relative Brightness (%)
L	L	L	L	0	0	0
L	L	L	H	1	0.2	1.7
L	L	H	L	2	0.4	3.3
L	L	H	H	3	0.6	5.0
L	H	L	L	4	0.8	6.7
L	H	L	H	5	1.0	8.3
L	H	H	L	7	1.4	11.7
L	H	H	H	9	1.8	15
H	L	L	L	11	2.1	18
H	L	L	H	14	2.7	23
H	L	H	L	18	3.5	30
H	L	H	H	22	4.3	37
H	H	L	L	28	5.5	47
H	H	L	H	36	7.0	60
H	H	H	L	48	9.4	80
H	H	H	H	60	11.7	100

Peak Current Brightness Control	Typical Peak Pixel Current (mA)	Relative Full Scale Current (Relative Brightness, %)
H L	4.0	31
L H	6.4	50
L L	9.3	73 (Default at Power Up)
H H	12.8	100

**SLEEP MODE**

L – DISABLES INTERNAL OSCILLATOR-DISPLAY BLANK  
H – NORMAL OPERATION

CONTROL WORD 1

H	L	L	L	L	L	D <sub>1</sub>	D <sub>0</sub>
---	---	---	---	---	---	----------------	----------------

↑  
Bit D<sub>7</sub>  
Set High  
to Select  
Control  
Word 1

Reserved for Future Use (Bits D<sub>2</sub>-D<sub>6</sub> must be set Low)

Serial/Simultaneous Data Out  
L – D<sub>out</sub> holds contents of Bit D<sub>7</sub>  
H – D<sub>out</sub> is functionally tied to D<sub>in</sub>

External Display Oscillator Prescaler  
L – Oscillator Freq + 1  
H – Oscillator Freq + 8

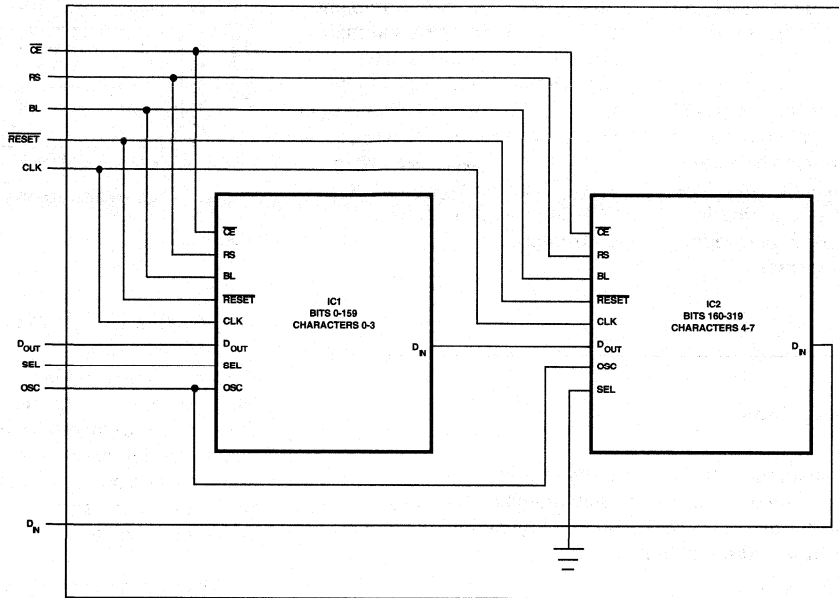

ALPHANUMERIC  
DISPLAYS

Figure 3. Cascaded ICs.

## Appendix A. Thermal Considerations

The display IC has a maximum junction temperature of 150°C. The IC junction temperature can be calculated with Equation 1 below.

A typical value for  $R\theta_{JA}$  is 100°C/W. This value is typical for a display mounted in a socket and covered with a plastic filter. The socket is soldered to a .062 in. thick PCB with .020 inch wide, one ounce copper traces.

$P_D$  can be calculated as Equation 2 below.

Figure 4 shows how to derate the power of one IC versus ambient temperature. Operation at high ambient temperatures may require the power per IC to be reduced. The power consumption can be reduced by changing either the  $N$ ,  $I_{PIXEL}$ , Osc cyc or  $V_{LED}$ . Changing  $V_{LOGIC}$  has very little impact on the power consumption.

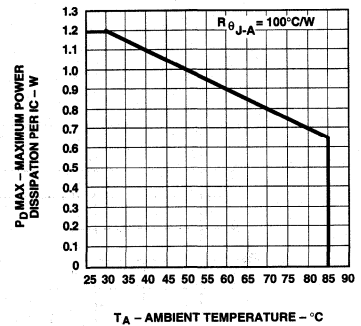

Figure 4.

### Equation 1:

$$T_{jMAX} = T_A + P_D * R\theta_{JA}$$

Where:

$T_{jMAX}$  = maximum IC junction temperature

$T_A$  = ambient temperature surrounding the display

$R\theta_{JA}$  = thermal resistance from the IC junction to ambient

$P_D$  = power dissipated by the IC

### Equation 2:

$$P_D = (N * I_{PIXEL} * \text{Duty Factor} * V_{LED}) + I_{LOGIC} * V_{LOGIC}$$

Where:

$P_D$  = total power dissipation

$N$  = number of pixels on (maximum 4 char \* 5 \* 7 = 140)

$I_{PIXEL}$  = peak pixel current.

Duty Factor = 1/8 \* Osc cyc/64

Osc cyc = number of ON oscillator cycles per row

$I_{LOGIC}$  = IC logic current

$V_{LOGIC}$  = logic supply voltage

### Equation 3:

$$I_{PEAK} = M * 20 * I_{PIXEL}$$

Where:

$I_{PEAK}$  = maximum instantaneous peak current for the display

$M$  = number of ICs in the system

20 = maximum number of LEDs on per IC

$I_{PIXEL}$  = peak current for one LED

### Equation 4:

$$I_{LED(AVG)} = N * I_{PIXEL} * 1/8 * (\text{oscillator cycles})/64$$

(see Variable Definitions above)

## Appendix B. Electrical Considerations

### Current Calculations

The peak and average display current requirements have a significant impact on power supply selection. The maximum peak current is calculated with Equation 3 below.

The average current required by the display can be calculated with Equation 4 below.

The power supply has to be able to supply  $I_{PEAK}$  transients and supply  $I_{LED(AVG)}$  continuously. The range on  $V_{LED}$  allows noise on this supply without significantly changing the display brightness.

### $V_{LOGIC}$ and $V_{LED}$ Considerations

The display uses two independent electrical systems. One system is used to power the display's logic and the other to power the display's LEDs. These two systems keep the logic supply clean.

Separate electrical systems allow the voltage applied to  $V_{LED}$  and  $V_{LOGIC}$  to be varied independently. Thus,  $V_{LED}$  can vary from 0 to 5.5 V without affecting either the Dot or the Control Registers.  $V_{LED}$  can

be varied between 4.0 to 5.5 V without any noticeable variation in light output. However, operating  $V_{LED}$  below 4.0 V may cause objectionable mismatch between the pixels and is not recommended. Dimming the display by pulse width modulating  $V_{LED}$  is also not recommended.

$V_{LOGIC}$  can vary from 3.0 to 5.5 V without affecting either the displayed message or the display intensity. However, operation below 4.5 V will change the timing and logic levels and operation below 3 V may cause the Dot and Control Registers to be altered.

The logic ground is internally connected to the LED ground by a substrate diode. This diode becomes forward biased and conducts when the logic ground is 0.4 V greater than the LED ground. The LED ground and the logic ground should be connected to a common ground which can withstand the current introduced by the switching LED drivers. When separate ground connections are used, the LED ground can vary from -0.3 V to +0.3 V with respect to the logic ground. Voltages below -0.3 V can cause all the dots to be ON. Voltage above +0.3 V can cause dimming and dot mismatch. The LED ground for the LED drivers can be routed separately from the logic ground until an appropriate ground plane is available. On long interconnections between the display and the host system, voltage drops on the analog ground can be kept from affecting the display logic levels by isolating the two grounds.

### Electrostatic Discharge

The inputs to the ICs are protected against static discharge and input current latchup. However, for best results, standard CMOS handling precautions should be used. Before use, the HCMS-29XX should be stored in antistatic tubes or in conductive material. During assembly, a grounded conductive work area should be used and assembly personnel should wear conductive wrist straps. Lab coats made of synthetic material should be avoided since they are prone to static buildup. Input current latchup is caused when the CMOS inputs are subjected to either a voltage below ground ( $V_{IN} < \text{ground}$ ) or to a voltage higher than  $V_{LOGIC}$  ( $V_{IN} > V_{LOGIC}$ ) and when a high current is forced into the input. To prevent input current latchup and ESD damage, unused inputs should be connected to either ground or  $V_{LOGIC}$ . Voltages should not be applied to the inputs until  $V_{LOGIC}$  has been applied to the display.

### Appendix C. Oscillator

The oscillator provides the internal refresh circuitry with a signal that is used to synchronize the columns and rows. This ensures that the right data is in the dot drivers for that row. This signal can be supplied from either an external source or the internal source.

A display refresh rate of 100 Hz or faster ensures flicker-free operation. Thus for an external oscillator the frequency should be greater than or equal to  $512 \times 100 \text{ Hz} = 51.2 \text{ kHz}$ . Operation above 1 MHz without the

prescaler or 8 MHz with the prescaler may cause noticeable pixel to pixel mismatch.

### Appendix D. Refresh Circuitry

This display driver consists of 20 one-of-eight column decoders and 20 constant current sources, 1 one-of-eight row decoder and eight row sinks, a pulse width modulation control block, a peak current control block, and the circuit to refresh the LEDs. The refresh counters and oscillator are used to synchronize the columns and rows.

The 160 bits are organized as 20 columns by 8 rows. The IC illuminates the display by sequentially turning ON each of the 8 row drivers. To refresh the display once takes 512 oscillator cycles. Because there are eight row drivers, each row driver is selected for 64 (512/8) oscillator cycles. Four cycles are used to briefly blank the display before the following row is switched on. Thus, each row is ON for 60 oscillator cycles out of a possible 64. This corresponds to the maximum LED on time.

### Appendix E. Display Brightness

Two ways have been shown to control the brightness of this LED display: setting the peak current and setting the duty factor. Both values are set in Control Word 0. To compute the resulting display brightness when both PWM and peak current control are used, simply multiply the two relative brightness factors. For example, if Control Register 0 holds the word 1001101, the peak current

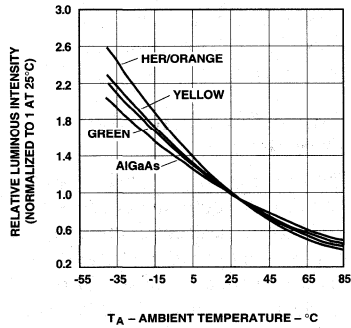

**Figure 5.**

is 73% of full scale (BIT D<sub>5</sub> = L, BIT D<sub>4</sub> = L) and the PWM is set to 60% duty factor (BIT D<sub>3</sub> = H, BIT D<sub>2</sub> = H, BIT D<sub>1</sub> = L, BIT D<sub>0</sub> = H). The resulting brightness is 44% (.73 x .60 = .44) of full scale.

The temperature of the display will also affect the LED brightness as shown in Figure 5.

## **Appendix F. Reference Material**

Application Note 1027: *Soldering LED Components*

Application Note 1015: *Contrast Enhancement Techniques for LED Displays*



# Eight Character 5 mm Smart Alphanumeric Display

## Technical Data

### HDSP-253X Series

#### Features

- XY Stackable
- 128 Character ASCII Decoder
- Programmable Functions
- 16 User Definable Characters
- Multi-Level Dimming and Blanking
- TTL Compatible CMOS IC
- Wave Solderable

#### Applications

- Avionics
- Computer Peripherals
- Industrial Instrumentation
- Medical Equipment
- Portable Data Entry Devices
- Telecommunications
- Test Equipment

#### Description

The HDSP-253X is ideal for applications where displaying eight or more characters of dot matrix information in an aesthetically pleasing manner is required. These devices are eight-digit, 5 x 7 dot matrix, alphanumeric displays. The 5.0 mm (0.2 inch) high characters are packaged in a 0.300 mm (7.62 inch) 30 pin DIP. The on-board CMOS IC has the ability to decode 128 ASCII characters, which are permanently stored in ROM. In addition, 16 programmable symbols may be stored in on-board RAM. Seven brightness levels provide versatility in adjusting the display intensity and power consumption. The HDSP-253X is designed for stan-

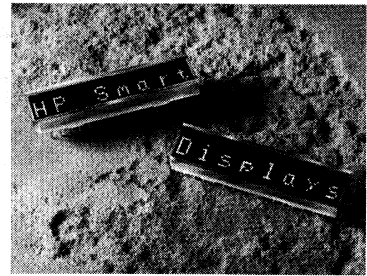

ALPHANUMERIC  
DISPLAYS

dard microprocessor interface techniques. The display and special features are accessed through a bidirectional eight-bit data bus.

#### Device Selection Guide

AlGaAs Red	HER	Orange	Yellow	Green
HDSP-2534	HDSP-2532	HDSP-2530	HDSP-2531	HDSP-2533

## Package Dimensions

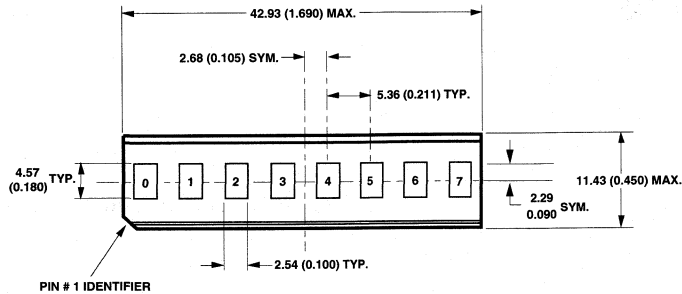

PIN FUNCTION ASSIGNMENT TABLE

PIN #	FUNCTION	PIN #	FUNCTION
1	RST	16	GND (SUPPLY)
2	FL	17	THERMAL TEST
3	A <sub>0</sub>	18	GND (LOGIC)
4	A <sub>1</sub>	19	RD
5	A <sub>2</sub>	20	D <sub>0</sub>
6	A <sub>3</sub>	21	D <sub>1</sub>
7	NO PIN	22	NO PIN
8	NO PIN	23	NO PIN
9	NO PIN	24	NO PIN
10	A <sub>4</sub>	25	D <sub>2</sub>
11	CLS	26	D <sub>3</sub>
12	CLK	27	D <sub>4</sub>
13	WR	28	D <sub>5</sub>
14	CE	29	D <sub>6</sub>
15	V <sub>DD</sub>	30	D <sub>7</sub>

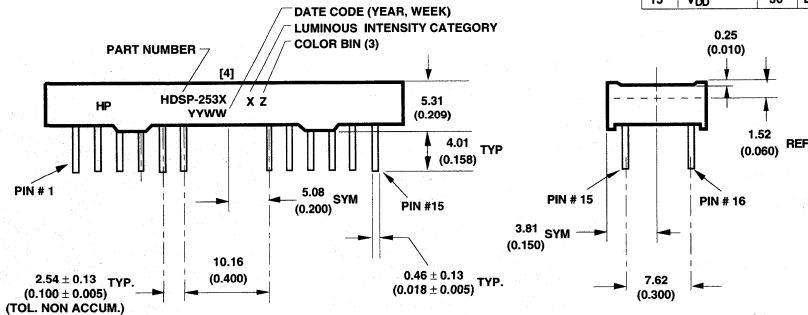

**NOTES:**

1. DIMENSIONS ARE IN MM (INCHES).
2. UNLESS OTHERWISE SPECIFIED, TOLERANCE ON DIMENSIONS IS  $\pm 0.25$  MM (0.010 IN.).
3. FOR YELLOW AND GREEN DISPLAYS ONLY.

## Absolute Maximum Ratings

Supply Voltage, V <sub>DD</sub> to Ground <sup>[1]</sup>	-0.3 V to 7.0 V
Operating Voltage, V <sub>DD</sub> to Ground <sup>[2]</sup>	5.5 V
Input Voltage, Any Pin to Ground	-0.3 V to V <sub>DD</sub> + 0.3 V
Free Air Operating Temperature Range, T <sub>A</sub> <sup>[3]</sup>	-40°C to + 85°C
Relative Humidity (Non-Condensing)	85%
Storage Temperature Range, T <sub>S</sub>	-55°C to 100°C
Maximum Solder Temperature	
1.59 mm (0.063 in.) Below Seating Plane, t < 5 sec.	260°C
ESD Protection @ 1.5 k $\Omega$ , 100 pF	4 kV (each pin)

**Notes:**

1. Maximum Voltage is with no LEDs illuminated.
2. 20 dots ON in all locations at full brightness.
3. See Thermal Considerations section for information about operation in high temperature ambients.

**ESD WARNING: NORMAL CMOS HANDLING PRECAUTIONS SHOULD BE OBSERVED TO AVOID STATIC DISCHARGE.**

## ASCII Character Set

BITS		COLUMNS								8-F
D7	D6	D5	D4	D3	D2	D1	D0	ROW		
0	0	0	0	0	0	0	0	0	1	X
0	0	0	0	1	0	1	1	0	1	X
0	0	0	1	0	1	0	1	0	1	X
0	0	1	0	1	0	0	1	0	1	X
0	1	0	1	0	1	0	0	1	1	X
0	1	0	1	0	0	1	0	1	1	X
0	1	1	0	1	0	0	0	1	1	X
0	1	1	0	0	1	0	0	1	1	X
1	0	0	0	0	0	0	0	0	0	
1	0	0	0	0	0	0	1	0	0	
1	0	0	0	0	1	0	0	0	0	
1	0	0	0	1	0	0	0	0	0	
1	0	0	1	0	0	0	0	0	0	
1	0	0	1	0	0	1	0	0	0	
1	0	1	0	0	0	0	0	0	0	
1	0	1	0	0	0	1	0	0	0	
1	0	1	0	1	0	0	0	0	0	
1	0	1	0	1	0	1	0	0	0	
1	1	0	0	0	0	0	0	0	0	
1	1	0	0	0	0	1	0	0	0	
1	1	0	0	1	0	0	0	0	0	
1	1	0	0	1	0	1	0	0	0	
1	1	1	0	0	0	0	0	0	0	
1	1	1	0	0	0	1	0	0	0	
1	1	1	0	1	0	0	0	0	0	
1	1	1	0	1	0	1	0	0	0	
1	1	1	1	0	0	0	0	0	0	
1	1	1	1	0	0	1	0	0	0	
1	1	1	1	1	0	0	0	0	0	
1	1	1	1	1	0	1	0	0	0	
1	1	1	1	1	1	0	0	0	0	
1	1	1	1	1	1	1	0	0	0	

ALPHANUMERIC  
DISPLAYS

## Optical Characteristics at 25°C<sup>[1]</sup>

V<sub>DD</sub> = 5.0 V at Full Brightness

LED Color	Part Number	Luminous Intensity Character Average (#) I <sub>v</sub> (mcd)		Peak Wavelength λ <sub>PEAK</sub> (nm) Typ.	Dominant Wavelength <sup>[2]</sup> λ <sub>d</sub> (nm) Typ.
		Min.	Typ.		
AlGaAs Red	HDSP-2534	5.1	25	645	637
High Eff. Red	HDSP-2532	2.5	7.5	635	626
Orange	HDSP-2530	2.5	7.5	600	602
Yellow	HDSP-2531	2.5	7.5	583	585
Green	HDSP-2533	2.5	7.5	568	574

### Notes:

- Refers to the initial case temperature of the device immediately prior to measurement.
- Dominant wavelength, λ<sub>d</sub>, is derived from the CIE chromaticity diagram, and represents the single wavelength which defines the color of the device.

## Recommended Operating Conditions

Parameter	Symbol	Minimum	Nominal	Maximum	Units
Supply Voltage	$V_{DD}$	4.5	5.0	5.5	V

## Electrical Characteristics over Operating Temperature Range

4.5 <  $V_{DD}$  < 5.5 unless otherwise specified

Parameter	Symbol	Min.	25°C Typ. <sup>[1]</sup>	25°C Max. <sup>[1]</sup>	Max.	Units	Test Conditions
Input Leakage (Input without pull-up)	$I_I$	-1.0			1.0	$\mu\text{A}$	$V_{IN} = 0$ to $V_{DD}$ , pins CLK, D <sub>0</sub> -D <sub>7</sub> , A <sub>0</sub> -A <sub>4</sub>
Input Current (Input with pull-up)	$I_{IP}$	-30	-11	-18	0	$\mu\text{A}$	$V_{IN} = 0$ to $V_{DD}$ , pins CLS, RST, WR, RD, CE, FL
$I_{DD}$ Blank	$I_{DD}(\text{BL})$		0.5	3.0	4.0	mA	$V_{IN} = V_{DD}$
$I_{DD}$ 8 digits 12 dots/char <sup>[2,3,4]</sup> (AlGaAs)	$I_{DD}(\text{V})$		230	295	390	mA	"V" on in all 8 locations
$I_{DD}$ 8 digits 20 dots/char <sup>[2,3,4]</sup> (AlGaAs)	$I_{DD}(\#)$		330	410	480	mA	"#" on in all 8 locations
$I_{DD}$ 8 digits 12 dots/char <sup>[2,3,4]</sup> (all colors except AlGaAs)	$I_{DD}(\text{V})$		200	255	330	mA	"V" on in all 8 locations
$I_{DD}$ 8 digits 20 dots/char <sup>[2,3,4]</sup> (all colors except AlGaAs)	$I_{DD}(\#)$		300	370	430	mA	"#" on in all 8 locations
Input Voltage High	$V_{IH}$	2.0			$V_{DD}$ +0.3 V	V	
Input Voltage Low	$V_{IL}$	GND -0.3 V				V	
Output Voltage High	$V_{OH}$	2.4				V	$V_{DD} = 4.5$ V, $I_{OH} = -40$ $\mu\text{A}$
Output Voltage Low D <sub>0</sub> -D <sub>7</sub>	$V_{OL}$				0.4	V	$V_{DD} = 4.5$ V, $I_{OL} = 1.6$ mA
Output Voltage Low CLK	$V_{OL}$				0.4	V	$V_{DD} = 4.5$ V, $I_{OL} = 40$ $\mu\text{A}$
Thermal Resistance IC Junction-to-PIN	$R\theta_{J-PIN}$		16			$^{\circ}\text{C}/\text{W}$	Measured at pin 17

### Notes:

- $V_{DD} = 5.0$  V.
- See Thermal Considerations Section for information about operation in high temperature ambients.
- Average  $I_{DD}$  measured at full brightness. See Table 2 in Control Word Section for  $I_{DD}$  at lower brightness levels.  
Peak  $I_{DD} = 28/15 \times I_{DD}(\#)$ .
- Maximum  $I_{DD}$  occurs at -55°C.

## AC Timing Characteristics over Temperature Range

$V_{DD} = 4.5$  to  $5.5$  V unless otherwise specified.

Reference Number	Symbol	Description	Min. <sup>[1]</sup>	Units
1	$t_{ACC}$	Display Access Time Write Read	210 230	ns
2	$t_{ACS}$	Address Setup Time to Chip Enable	10	ns
3	$t_{CE}$	Chip Enable Active Time <sup>[2, 3]</sup> Write Read	140 160	ns
4	$t_{ACH}$	Address Hold Time to Chip Enable	20	ns
5	$t_{CER}$	Chip Enable Recovery Time	60	ns
6	$t_{CES}$	Chip Enable Active Prior to Rising Edge of <sup>[2, 3]</sup> Write Read	140 160	ns
7	$t_{CEH}$	Chip Enable Hold Time to Rising Edge of Read/Write Signal <sup>[2, 3]</sup>	0	ns
8	$t_W$	Write Active Time	100	ns
9	$t_{WD}$	Data Valid Prior to Rising Edge of Write Signal	50	ns
10	$t_{DH}$	Data Write Hold Time	20	ns
11	$t_R$	Chip Enable Active Prior to Valid Data	160	ns
12	$t_{RD}$	Read Active Prior to Valid Data	75	ns
13	$t_{DF}$	Read Data Float Delay	10	ns
	$t_{RC}$	Reset Active Time <sup>[4]</sup>	300	ns

### Notes:

1. Worst case values occur at an IC junction temperature of 125°C.
2. For designers who do not need to read from the display, the Read line can be tied to  $V_{DD}$  and the Write and Chip Enable lines can be tied together.
3. Changing the logic levels of the Address lines when  $\overline{CE} = "0"$  may cause erroneous data to be entered into the Character RAM, regardless of the logic levels of the WR and RD lines.
4. The display must not be accessed until after 3 clock pulses (110  $\mu$ s min. using the internal refresh clock) after the rising edge of the reset line.

Symbol	Description	25°C Typical	Minimum <sup>[1]</sup>	Units
$F_{OSC}$	Oscillator Frequency	57	28	kHz
$F_{RF}$ <sup>[5]</sup>	Display Refresh Rate	256	128	Hz
$F_{FL}$ <sup>[6]</sup>	Character Flash Rate	2	1	Hz
$t_{ST}$ <sup>[7]</sup>	Self Test Cycle Time	4.6	9.2	sec

### Notes:

5.  $F_{RF} = F_{OSC}/224$ .
6.  $F_{FL} = F_{OSC}/28,672$ .
7.  $t_{ST} = 262,144/F_{OSC}$ .

### Write Cycle Timing Diagram

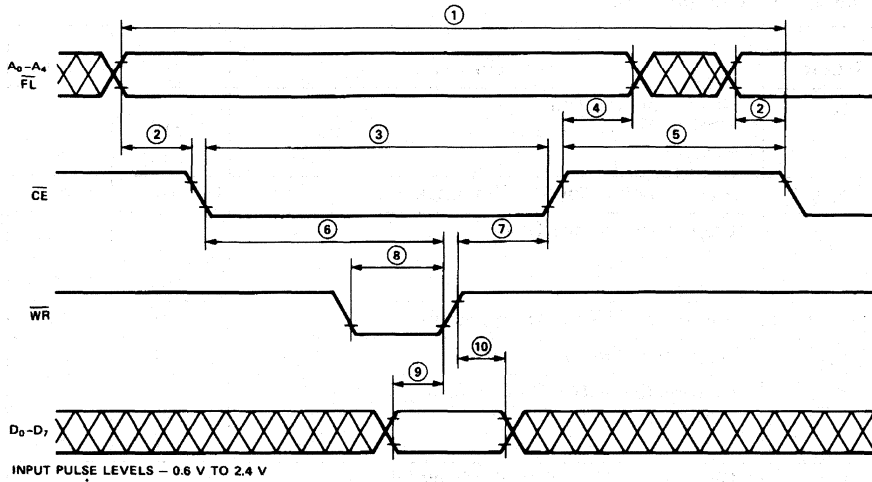

### Read Cycle Timing Diagram

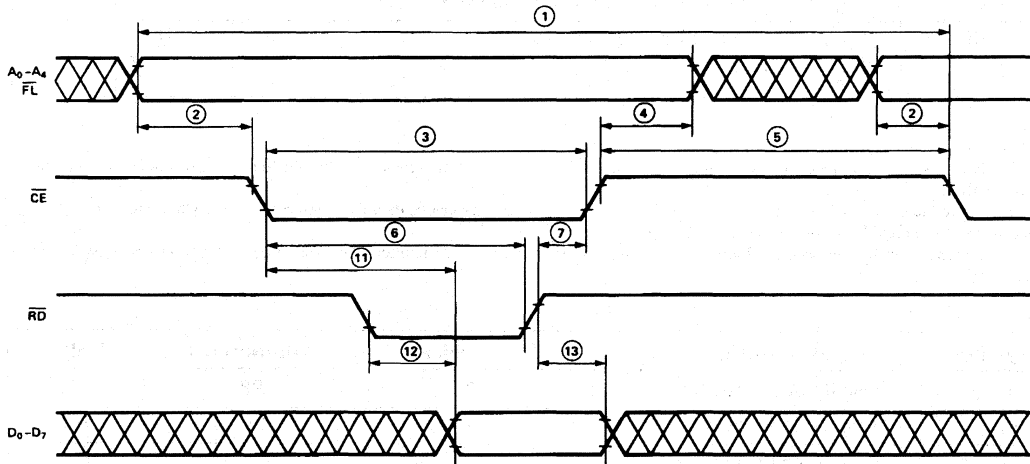

INPUT PULSE LEVELS: 0.6 V TO 2.4 V  
 OUTPUT REFERENCE LEVELS: 0.6 V TO 2.2 V  
 OUTPUT LOADING = 1 TTL LOAD AND 100pF

## Electrical Description

### Pin Function

RESET ( $\overline{\text{RST}}$ , pin 1)

FLASH ( $\overline{\text{FL}}$ , pin 2)

ADDRESS INPUTS  
( $A_0$ - $A_4$ , pins 3-6, 10)

### Description

Reset initializes the display.

$\overline{\text{FL}}$  low indicates an access to the Flash RAM and is unaffected by the state of address lines  $A_3$ - $A_4$ .

Each location in memory has a distinct address. Address inputs ( $A_0$ - $A_2$ ) select a specific location in the Character RAM, the Flash RAM or a particular row in the UDC (User-Defined Character) RAM.  $A_3$ - $A_4$  are used to select which section of memory is accessed. Table 1 shows the logic levels needed to access each section of memory.

**Table 1. Logic Levels to Access Memory**

$\overline{\text{FL}}$	$A_4$	$A_3$	Section of Memory	$A_2 A_1 A_0$
0	X	X	Flash RAM	Character Address
1	0	0	UDC Address Register	Don't Care
1	0	1	UDC RAM	Row Address
1	1	0	Control Word Register	Don't Care
1	1	1	Character RAM	Character Address

CLOCK SELECT  
(CLS, pin 11)

This input is used to select either an internal (CLS = 1) or external (CLS = 0) clock source.

CLOCK INPUT/OUTPUT  
(CLK, pin 12)

Outputs the master clock (CLS = 1) or inputs a clock (CLS = 0) for slave displays.

WRITE ( $\overline{\text{WR}}$ , pin 13)

Data is written into the display when the  $\overline{\text{WR}}$  input is low and the  $\overline{\text{CE}}$  input is low.

CHIP ENABLE ( $\overline{\text{CE}}$ , pin 14)

This input must be at a logic low to read or write data to the display and must go high between each read and write cycle.

READ ( $\overline{\text{RD}}$ , pin 19)

Data is read from the display when the  $\overline{\text{RD}}$  input is low and the  $\overline{\text{CE}}$  input is low.

DATA Bus  
( $D_0$ - $D_7$ , pins 20, 21, 25-30)

The Data bus is used to read from or write to the display.

GND (SUPPLY) (pin 16)

This is the analog ground for the LED drivers.

GND (LOGIC) (pin 18)

This is the digital ground for internal logic.

$V_{DD}$  (POWER) (pin 15)

This is the positive power supply input.

Thermal Test (pin 17)

This pin is used to measure the IC junction temperature.  
Do not connect.

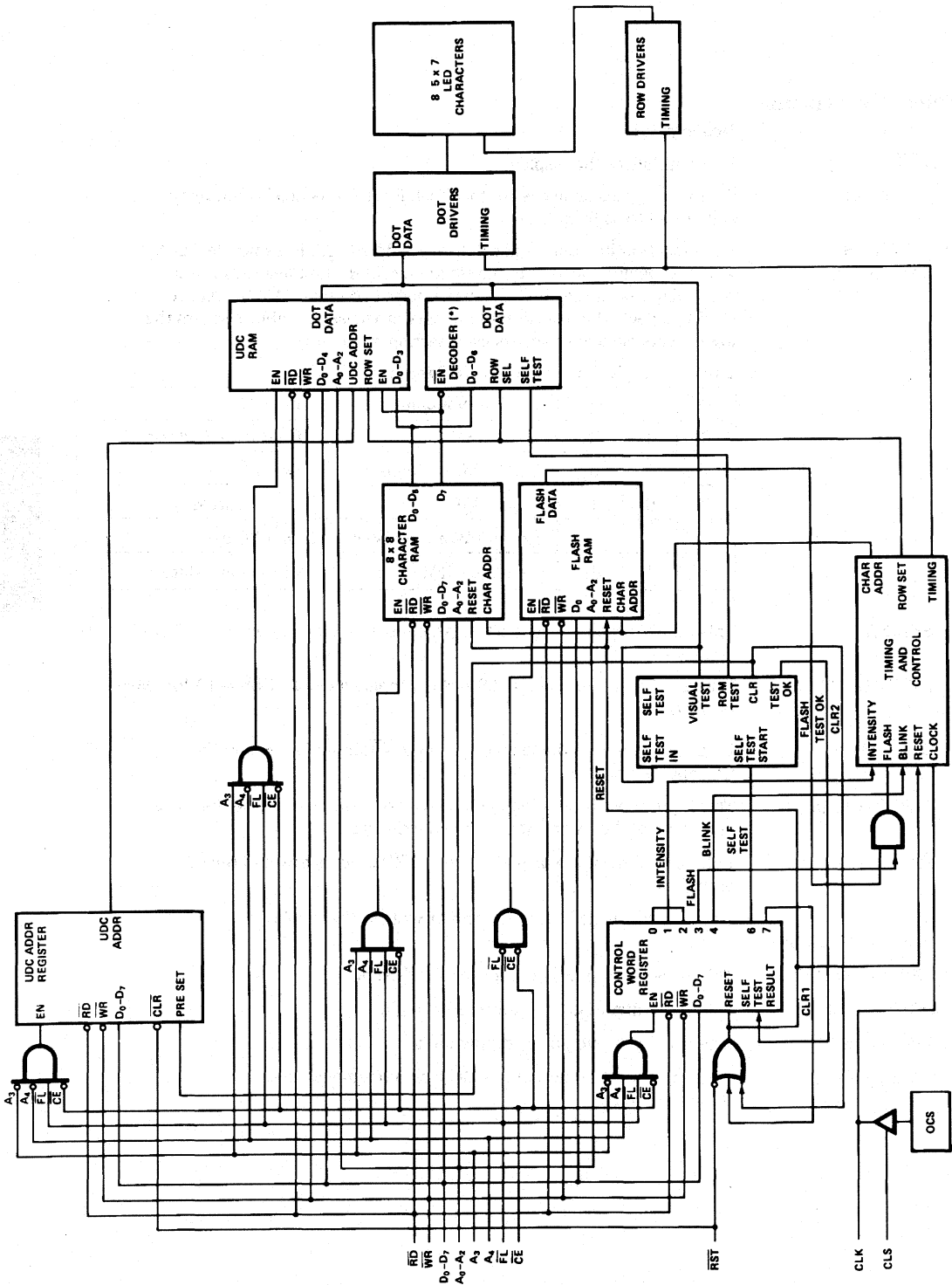

Figure 1. HDSP-253X Internal Block Diagram.



### Display Internal Block Diagram

Figure 1 shows the internal block diagram of the HDSP-253X display. The CMOS IC consists of an 8 byte Character RAM, an 8 bit

Flash RAM, a 128 character ASCII decoder, a 16 character UDC RAM, a UDC Address Register, a Control Word Register and the refresh circuitry necessary to synchronize the decoding and

driving of eight 5 x 7 dot matrix characters. The major user accessible portions of the display are listed below:

Character RAM	This RAM stores either ASCII character data or a UDC RAM address.
Flash RAM	This is a 1 x 8 RAM which stores Flash data.
User-Defined Character RAM (UDC RAM)	This RAM stores the dot pattern for custom characters.
User-Defined Character Address Register (UDC Address Register)	This register is used to provide the address to the UDC RAM when the user is writing or reading a custom character.
Control Word Register	This register allows the user to adjust the display brightness, flash individual characters, blink, self test or clear the display.

### Character Ram

Figure 2 shows the logic levels needed to access the HDSP-253X Character RAM. During a normal access the  $\overline{CE}$  = "0" and either  $\overline{RD}$  = "0" or  $\overline{WR}$  = "0". However, erroneous data may be written into the Character RAM if the Address lines are unstable when  $\overline{CE}$  = "0" regardless of the logic levels of the  $\overline{RD}$  or  $\overline{WR}$  lines. Address lines  $A_0$ - $A_2$  are used to select the location in the Character RAM. Two types of data can be stored in each Character RAM location: an ASCII code or a UDC RAM address. Data bit  $D_7$  is used to differentiate between the ASCII character and a UDC RAM address.  $D_7 = 0$  enables the ASCII decoder and  $D_7 = 1$  enables the UDC RAM.  $D_0$ - $D_6$  are used to input ASCII data and  $D_0$ - $D_3$  are used to input a UDC address.

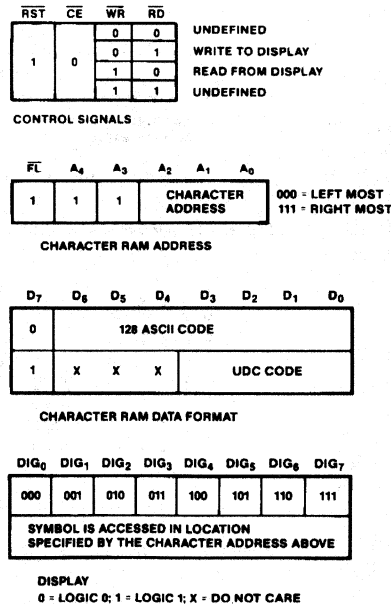

Figure 2. Logic Levels to Access the Character RAM.

### UDC RAM and UDC Address Register

Figure 3 shows the logic levels needed to access the UDC RAM and the UDC Address Register. The UDC Address Register is eight bits wide. The lower four bits (D<sub>0</sub>-D<sub>3</sub>) are used to select one of the 16 UDC locations. The upper four bits (D<sub>4</sub>-D<sub>7</sub>) are not used. Once the UDC address has been stored in the UDC Address Register, the UDC RAM can be accessed.

To completely specify a 5 x 7 character requires eight write cycles. One cycle is used to store the UDC RAM address in the UDC Address Register. Seven cycles are used to store dot data in the UDC RAM. Data is entered by rows. One cycle is needed to access each row. Figure 4 shows the organization of a UDC character assuming the symbol to be stored is an "F." A<sub>0</sub>-A<sub>2</sub> are used to select the row to be accessed and D<sub>0</sub>-D<sub>4</sub> are used to transmit the row dot data. The upper three bits (D<sub>5</sub>-D<sub>7</sub>) are ignored. D<sub>0</sub> (least significant bit) corresponds to the right most column of the 5 x 7 matrix and D<sub>4</sub> (most significant bit) corresponds to the left most column of the 5 x 7 matrix.

### Flash RAM

Figure 5 shows the logic levels needed to access the Flash RAM. The Flash RAM has one bit associated with each location of the Character RAM. The Flash input is used to select the Flash RAM. Address lines A<sub>3</sub>-A<sub>4</sub> are ignored. Address lines A<sub>0</sub>-A<sub>2</sub> are used to select the location in the Flash RAM to store the attribute. D<sub>0</sub> is used to store or remove the flash attribute. D<sub>0</sub> = "1" stores the attribute and D<sub>0</sub> = "0" removes the attribute.

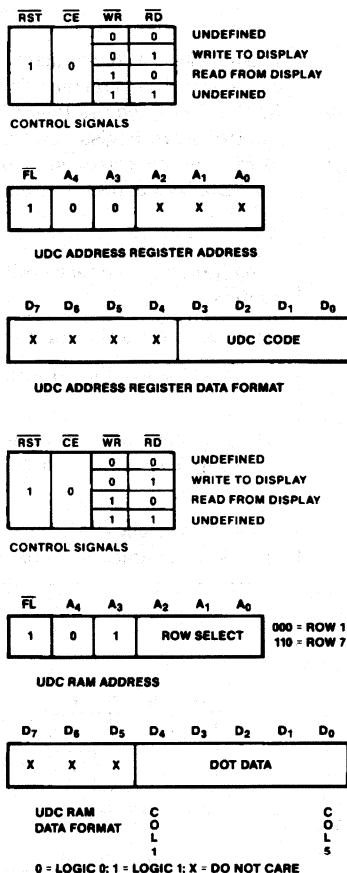

Figure 3. Logic Levels to Access a UDC Character.

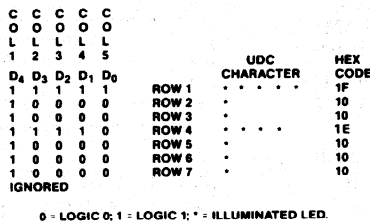

Figure 4. Data to Load "F" into the UDC RAM.

When the attribute is enabled through bit 3 of the Control Word and a "1" is stored in the Flash RAM, the corresponding character will flash at approxi-

mately 2 Hz. The actual rate is dependent on the clock frequency. For an external clock the flash rate can be calculated by dividing the clock frequency by 28,672.

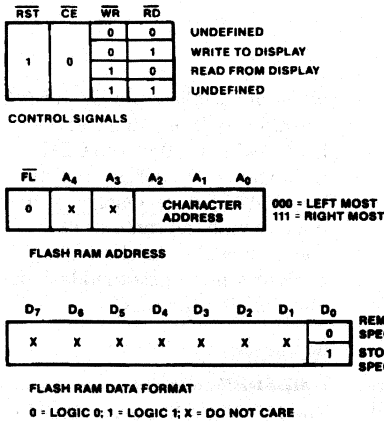

Figure 5. Logic Levels to Access the Flash RAM.

### Control Word Register

Figure 6 shows how to access the Control Word Register. This is an eight bit register which performs five functions. They are Brightness control, Flash RAM control, Blinking, Self Test and Clear. Each function is independent of the others. However, all bits are updated during each Control Word write cycle.

#### Brightness (Bits 0-2)

Bits 0-2 of the Control Word adjust the brightness of the display. Bits 0-2 are interpreted as a three bit binary code with code (000) corresponding to maximum brightness and code (111) corresponding to a blanked display. In addition to varying the display brightness, bits 0-2 also vary the average value of  $I_{DD}$ .  $I_{DD}$  can be calculated at any brightness level by multiplying the percent brightness level by the value of  $I_{DD}$  at the 100% brightness level. These values of  $I_{DD}$  are shown in Table 2.

#### Flash Function (Bit 3)

Bit 3 determines whether the flashing character attribute is on or off. When bit 3 is a "1," the output of the Flash RAM is checked. If the content of a location in the Flash RAM is a "1," the associated digit will flash at

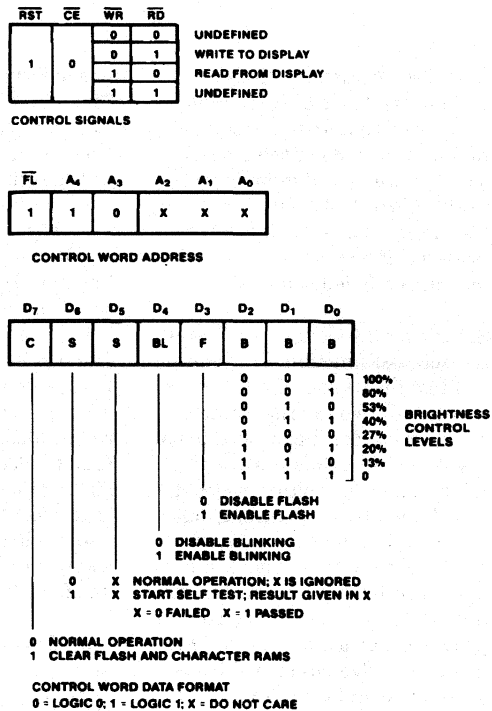

Figure 6. Logic Levels to Access the Control Word Register

Table 2. Current Requirements at Different Brightness Levels for All Colors Except AlGaAs

Symbol	D <sub>2</sub>	D <sub>1</sub>	D <sub>0</sub>	% Brightness	V <sub>DD</sub> = 5.0 V 25°C Typ.	Units
I <sub>DD</sub> (V)	0	0	0	100	200	mA
	0	0	1	80	160	mA
	0	1	0	53	106	mA
	0	1	1	40	80	mA
	1	0	0	27	54	mA
	1	0	1	20	40	mA
	1	1	0	13	26	mA

approximately 2 Hz. For an external clock, the blink rate can be calculated by dividing the clock frequency by 28,672. If the flash enable bit of the Control Word is a "0," the content of the Flash RAM is ignored. To use this function with multiple display systems see the Reset section.

#### Blink Function (Bit 4)

Bit 4 of the Control Word is used to synchronize blinking of all

eight digits of the display. When this bit is a "1" all eight digits of the display will blink at approximately 2 Hz. The actual rate is dependent on the clock frequency. For an external clock, the blink rate can be calculated by dividing the clock frequency by 28,672. This function will override the Flash function when it is active. To use this function with multiple display systems see the Reset section.

ALPHANUMERIC DISPLAYS

### Self Test Function (Bits 5, 6)

Bit 6 of the Control Word Register is used to initiate the self test function. Results of the internal self test are stored in bit 5 of the Control Word. Bit 5 is a read only bit where bit 5 = "1" indicates a passed self test and bit 5 = "0" indicates a failed self test.

Setting bit 6 to a logic 1 will start the self test function. The built-in self test function of the IC consists of two internal routines which exercises major portions of the IC and illuminates all of the LEDs. The first routine cycles the ASCII decoder ROM through all states and performs a checksum on the output. If the checksum agrees with the correct value, bit 5 is set to "1." The second routine provides a visual test of the LEDs using the drive circuitry. This is accomplished by writing checkered and inverse checkered patterns to the display. Each pattern is displayed for approximately 2 seconds.

During the self test function the display must not be accessed. The time needed to execute the self test function is calculated by multiplying the clock period by 262,144. For example, assume a clock frequency of 58 KHz, then the time to execute the self test function frequency is equal to  $(262,144/58,000) = 4.5$  second duration.

At the end of the self test function, the Character RAM is loaded with blanks, the Control Word Register is set to zeros except for bit 5, and the Flash RAM is cleared and the UDC Address Register is set to all ones.

### Clear Function (Bit 7)

Bit 7 of the Control Word will clear the Character RAM and the Flash RAM. Setting bit 7 to a "1" will start the clear function. Three clock cycles (110  $\mu$ s min. using the internal refresh clock) are required to complete the clear function. The display must not be accessed while the display is being cleared. When the clear function has been completed, bit 7 will be reset to a "0." The ASCII character code for a space (20H) will be loaded into the Character RAM to blank the display and the Flash RAM will be loaded with "1"s. The UDC RAM, UDC Address Register and the remainder of the Control Word are unaffected.

### Display Reset

Figure 7 shows the logic levels needed to reset the display. The display should be reset on Power-up. The external Reset clears the Character RAM, Flash RAM, Control Word and resets the internal counters. After the rising edge of the Reset signal, three clock cycles (110  $\mu$ s min. using the internal refresh clock) are required to complete the reset sequence. The display must not be accessed while the display is being reset. The ASCII Character code for a space (20H) will be loaded into the Character RAM to

blank the display. The Flash RAM and Control Word Register are loaded with all "0"s. The UDC RAM and UDC Address Register are unaffected. All displays which operate with the same clock source must be simultaneously reset to synchronize the Flashing and Blinking functions.

### Mechanical Considerations

The HDSP-253X is assembled by die attaching and wire bonding 280 LED chips and a CMOS IC to a thermally conductive printed circuit board. A polycarbonate lens placed over the pcb creates an air gap over the LED wire bonds. A backfill epoxy seals the display package.

Figure 8 shows the proper method to insert the display by hand. To prevent damage to the LED wire bonds, apply pressure uniformly with fingers located at both ends of the part. Using a tool, shown in Figure 9, such as a screwdriver or pliers to push the display into the printed circuit board or socket may damage the LED wire bonds. The force exerted by a screwdriver is sufficient to push the lens into the LED wire bonds. The bent wire bonds cause shorts or opens that result in catastrophic failure of the LEDs.

RST	CE	WR	RD	FL	A <sub>3</sub> -A <sub>0</sub>	D <sub>7</sub> -D <sub>0</sub>
0	1	X	X	X	X	X

0 - LOGIC 0; 1 - LOGIC 1; X - DO NOT CARE  
NOTE:  
IF RST, CE AND WR ARE LOW, UNKNOWN  
DATA MAY BE WRITTEN INTO THE DISPLAY.

Figure 7. Logic Levels to Reset the Display.

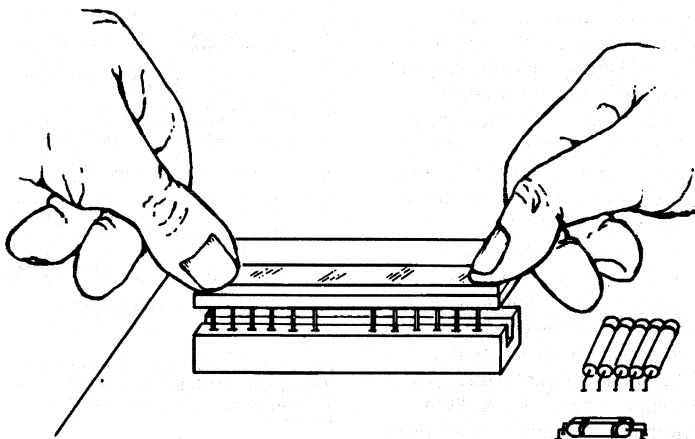

Figure 8. Proper Method to Manually Insert a Display.

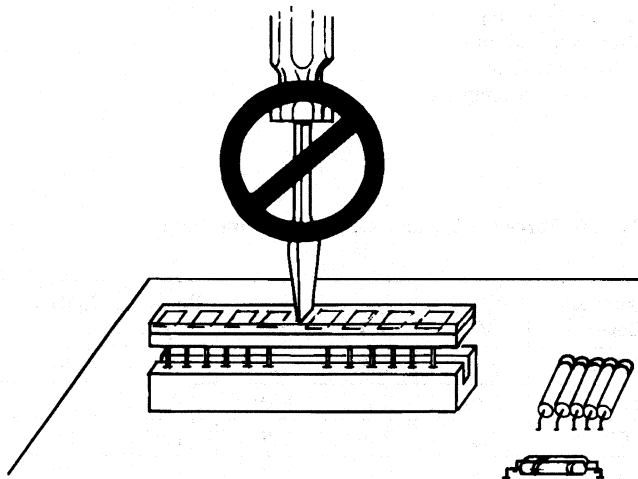

Figure 9. Improper Method to Manually Insert a Display.

### Thermal Considerations

The HDSP-253X can operate from  $-40^{\circ}\text{C}$  to  $+85^{\circ}\text{C}$ . The display's low thermal resistance allows heat to flow from the CMOS IC to the 24 package pins. Typically, this heat is conducted through the printed

circuit board traces to free air. For most applications, no additional heatsinking is needed. Illuminating all 280 LEDs simultaneously at full brightness is not recommended for continuous operation. However, all 280 LEDs can be illuminated simul-

taneously at full brightness for 10 seconds at  $25^{\circ}\text{C}$  as a lamp test.

The IC has a maximum allowable junction temperature of  $150^{\circ}\text{C}$ . The IC junction temperature can be calculated with the following equation:

$$T_{J\text{MAX}} = T_A + (P_D \times R\theta_{J-A})$$

$T_{J\text{MAX}}$  is the maximum allowable IC junction temperature.

$T_A$  is the ambient temperature surrounding the display.

$P_D$  is the power dissipated by the IC.

$R\theta_{J-A}$  is the thermal resistance from the IC through the display package and printed circuit board to the ambient.

A typical value for  $R\theta_{J-A}$  is  $39^{\circ}\text{C}/\text{W}$ . This value is typical for a display mounted in a socket and covered with a plastic filter. The socket is soldered to a 0.062 in. thick printed circuit board with 0.020 in. wide one-ounce copper traces.

$P_D$  can be calculated as follows:

$$P_D = V_{DD} \times I_{DD}$$

$V_{DD}$  is the supply voltage and  $I_{DD}$  is the supply current.

$V_{DD}$  can vary from 4.5 V to 5.5 V.

$I_{DD}$  changes with  $V_{DD}$ , temperature, brightness level, and number of on-pixels.

For AlGaAs

$$I_{DD}(\#) = (83.8 \times V_{DD} - 0.35 \times T_J) \times B \times N/8$$

$$I_{DD}(V) = (63 \times V_{DD} - 0.79 \times T_J) \times B \times N/8$$

For the other colors

$$I_{DD}(\#) = (75.4 \times V_{DD} - 0.28 \times T_J) \times B \times N/8$$

$$I_{DD}(V) = (54 \times V_{DD} - 0.6 \times T_j) \times B \times N/8$$

$I_{DD}(\#)$  is the supply current using “#” as the displayed character.

$I_{DD}(V)$  is the supply current using “V” as the displayed character.

$T_j$  is the IC junction temperature. B is the percent brightness level. N is the number of characters illuminated.

Operation in high temperature ambients may require power derating or heatsinking. Figure 10 shows how to derate the power for an HDSP-253X. You can reduce the power by tighter supply voltage regulation or lowering the brightness level.

Table 3 shows the calculated maximum allowable ambient temperature for several different sets of operating conditions. The

worst case alphanumeric characters (#,@,B) have 20 pixels. Displaying eight 20-pixel characters will not occur in normal operation. Thus, using eight 20-pixel characters to calculate power dissipation will over estimate the power and the IC junction temperature. The average number of pixels per character, supply voltage, brightness level, and number of characters are needed to calculate the power dissipated by the IC. The ambient temperature, power dissipated by the IC, and the thermal resistance are then used to calculate IC junction temperature. The typical alphanumeric character is 15 pixels. For conditions not listed in Table 3, you can calculate the power dissipated by the IC and use Figure 10 to determine the maximum ambient temperature.

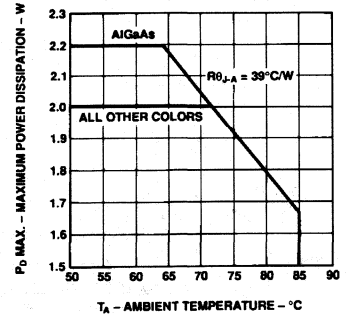

Figure 10. Maximum Allowable Power Dissipation vs. Ambient Temperature.  $T_j$ MAX = 150 °C or 120 °C.

Table 3. Maximum Allowable Ambient Temperature for Various Operating Conditions

**AlGaAs Red**

Character	Number of Characters	Brightness Level	$V_{DD}$ V	$I_{DD}$ mA	$P_D$ W	$R\theta_{J-A}$ °C/W	$T_A$ MAX °C
# (20 dots)	8	100%	5.5	408	2.2	39	64
# (20 dots)	8	100%	5.25	387	2.0	39	72
# (20 dots)	8	100%	5.0	366	1.8	39	80
# (20 dots)	7	100%	5.5	357	2.0	39	72
# (20 dots)	6	100%	5.5	306	1.7	39	84
# (20 dots)	8	80%	5.5	327	1.8	39	80
# (20 dots)	8	80%	5.25	310	1.6	39	85
# (20 dots)	8	53%	5.5	216	1.2	39	85
V (12 dots)	8	100%	5.5	228	1.3	39	85

**Table 3. Maximum Allowable Ambient Temperature for Various Operating Conditions (cont'd.)****All Colors Except ALGaAs Red**

Character	Number of Characters	Brightness Level	V <sub>DD</sub> V	I <sub>DD</sub> mA	P <sub>D</sub> W	R $\theta_{J-A}$ °C/W	T <sub>A</sub> MAX °C
# (20 dots)	8	100%	5.5	373	2.0	39	72
# (20 dots)	8	100%	5.25	354	1.9	39	77
# (20 dots)	8	100%	5.0	335	1.67	39	85
# (20 dots)	7	100%	5.5	326	1.8	39	80
# (20 dots)	6	100%	5.5	280	1.5	39	85
# (20 dots)	8	80%	5.5	298	1.6	39	85
V (12 dots)	8	100%	5.5	207	1.1	39	85

The actual IC temperature is easy to measure. Pin 17 is thermally and electrically connected to the IC substrate. The thermal resistance from pin 17 to the IC is 16°C/W. The procedure to measure the IC junction temperature is as follows:

1. Measure V<sub>DD</sub> and I<sub>DD</sub> for the display. Measure V<sub>DD</sub> between pins 15 and 16. Measure the current entering pin 15.
2. Measure the temperature of pin 17 after 45 minutes. Use an electrically isolated thermal couple probe.
3.  $T_J(IC) = T_{pin} + V_{DD} \times I_{DD} \times 16^\circ C/W$ .

### Ground Connections

Two ground pins are provided to keep the internal IC logic ground clean. The designer can, when necessary, route the analog ground for the LED drivers separately from the logic ground until an appropriate ground plane is available. On long interconnections between the display and the host system, the designer can keep voltage drops on the analog ground from affecting the display logic levels by isolating the two grounds.

The logic ground should be connected to the same ground potential as the logic interface circuitry. The analog ground and the logic ground should be connected at a common ground which can withstand the current induced by the switching LED drivers.

When separate ground connections are used, the analog ground can vary from -0.3 V to +0.3 V with respect to the logic ground. Voltage below -0.3 V can cause all dots to be on. Voltage above +0.3 V can cause dimming and dot mismatch.

### Solder and Post Solder Cleaning

Note: Freon vapors can cause the black paint to peel off the display. See Application Note 1027 for information on soldering and post solder cleaning.

### Contrast Enhancement (Filtering)

See Application Note 1015 for information on contrast enhancement.

# Eight Character 5 mm and 7 mm Smart Alphanumeric Displays

## Technical Data

### HDSP-210X Series HDSP-211X Series HDSP-250X Series

#### Features

- X Stackable (HDSP-21XX)
- XY Stackable (HDSP-250X)
- 128 Character ASCII Decoder
- Programmable Functions
- 16 User Definable Characters
- Multi-Level Dimming and Blanking
- TTL Compatible CMOS IC
- Wave Solderable

#### Applications

- Computer Peripherals
- Industrial Instrumentation
- Medical Equipment
- Portable Data Entry Devices
- Cellular Phones

- Telecommunications Equipment
- Test Equipment

#### Description

The HDSP-210X/-211X/-250X series of products is ideal for applications where displaying eight or more characters of dot matrix information in an aesthetically pleasing manner is required. These devices are 8-digit, 5 x 7 dot matrix, alphanumeric displays and are all packaged in a standard 15.24 mm (0.6 inch) 28 pin DIP. The on-board CMOS IC has the ability to decode 128 ASCII characters which are permanently stored in ROM. In addition, 16 programmable symbols may be stored in on-board ROM, allowing consider-

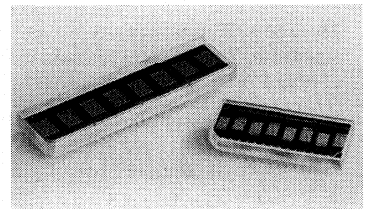

able flexibility for displaying additional symbols and icons. Seven brightness levels provide versatility in adjusting the display intensity and power consumption. The HDSP-210X/-211X/-250X products are designed for standard microprocessor interface techniques. The display and special features are accessed through a bidirectional 8-bit data bus.

#### Device Selection Guide

Font Height	AlGaAs Red	High Efficiency Red	Orange	Yellow	Green
0.2 inches	HDSP-2107	HDSP-2112	HDSP-2110	HDSP-2111	HDSP-2113
0.27 inches	-	HDSP-2502	HDSP-2500	HDSP-2501	HDSP-2503



## Package Dimensions

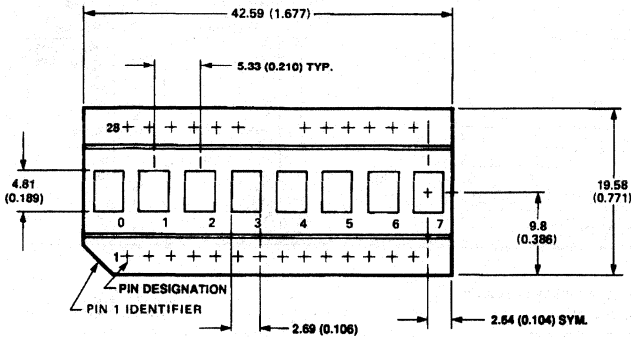

**Pin Function Assignment Table**

Pin No.	Function	Pin No.	Function
1	RST	15	GND(SUPPLY)
2	FL	16	GND (LOGIC)
3	A <sub>0</sub>	17	ZE
4	A <sub>1</sub>	18	RD
5	A <sub>2</sub>	19	D <sub>0</sub>
6	A <sub>3</sub>	20	D <sub>1</sub>
7	DO NOT CONNECT	21	NO PIN
8	DO NOT CONNECT	22	NO PIN
9	DO NOT CONNECT	23	D <sub>2</sub>
10	A <sub>4</sub>	24	D <sub>3</sub>
11	CLS	25	D <sub>4</sub>
12	CLK	26	D <sub>5</sub>
13	WR	27	D <sub>6</sub>
14	V <sub>DD</sub>	28	D <sub>7</sub>

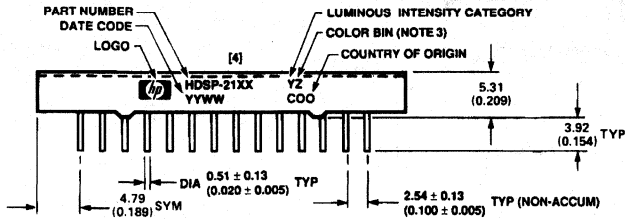

- NOTES:**  
 1. DIMENSIONS ARE IN mm (INCHES).  
 2. UNLESS OTHERWISE SPECIFIED, TOLERANCE ON ALL DIMENSIONS IS  $\pm 0.25$  mm (0.010 INCH).  
 3. FOR YELLOW AND GREEN DEVICES ONLY.

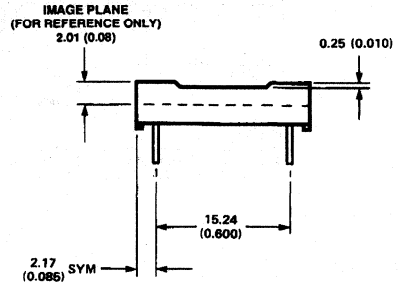

ALPHANUMERIC DISPLAYS

## Absolute Maximum Ratings

Supply Voltage, V <sub>DD</sub> to Ground <sup>[1]</sup>	-0.3 to 7.0 V
Operating Voltage, V <sub>DD</sub> to Ground <sup>[2]</sup>	5.5 V
Input Voltage, Any Pin to Ground	-0.3 to V <sub>DD</sub> + 0.3 V
Free Air Operating Temperature Range, T <sub>A</sub> <sup>[3]</sup>	-45°C to +85°C
Storage Temperature Range, T <sub>S</sub>	-55°C to +100°C
Relative Humidity (non-condensing)	85%
Maximum Solder Temperature (Below Seating Plane), t < 5 sec	260°C
ESD Protection @ 1.5 kΩ, 100 pF	V <sub>Z</sub> = 4 kV (each pin)

- Notes:**  
 1. Maximum Voltage is with no LEDs illuminated.  
 2. 20 dots ON in all locations at full brightness.  
 3. Maximum supply voltage is 5.25 V for operation above 70°C.

**ESD WARNING: STANDARD CMOS HANDLING PRECAUTIONS SHOULD BE OBSERVED TO AVOID STATIC DISCHARGE.**

# Package Dimensions

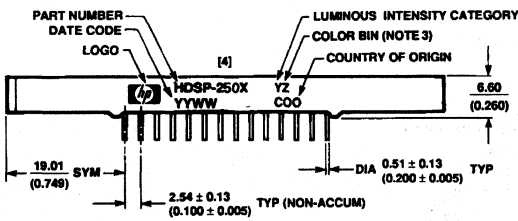
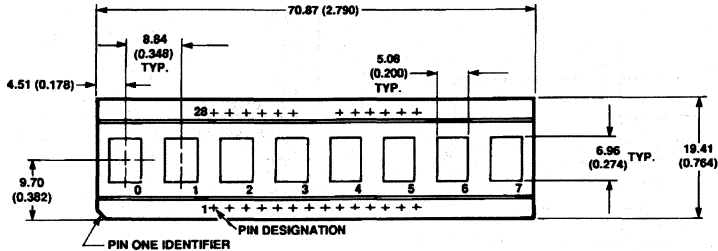

- NOTES:
1. DIMENSIONS ARE IN mm (INCHES).
  2. UNLESS OTHERWISE SPECIFIED, TOLERANCE ON ALL DIMENSIONS IS  $\pm 0.25$  mm (0.010 INCH).
  3. FOR YELLOW AND GREEN DEVICES ONLY.

**Pin Function Assignment Table**

Pin No.	Function	Pin No.	Function
1	RST	15	GND(SUPPLY)
2	FL	16	GND (LOGIC)
3	A <sub>0</sub>	17	CE
4	A <sub>1</sub>	18	RD
5	A <sub>2</sub>	19	D <sub>0</sub>
6	A <sub>3</sub>	20	D <sub>1</sub>
7	DO NOT CONNECT	21	NO PIN
8	DO NOT CONNECT	22	NO PIN
9	DO NOT CONNECT	23	D <sub>2</sub>
10	A <sub>4</sub>	24	D <sub>3</sub>
11	CLS	25	D <sub>4</sub>
12	CLK	26	D <sub>5</sub>
13	WR	27	D <sub>6</sub>
14	V <sub>DD</sub>	28	D <sub>7</sub>

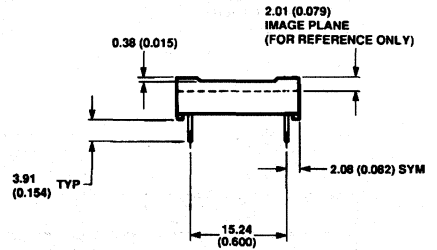

## ASCII Character Set HDSP-210X, HDSP-211X, HDSP-250X Series

BITS		COLUMNS								8-F
D7	D6	D5	D4	D3	D2	D1	D0	ROW		
0	0	0	0	0	0	0	0	0	1	
0	0	0	0	1	0	1	0	0	X	
0	0	0	1	0	1	0	0	1	X	
0	0	1	0	1	0	0	1	0	X	
0	1	0	0	0	0	0	0	0		
0	1	0	0	0	0	0	1	0		
0	1	0	0	1	0	0	0	0		
0	1	0	1	0	0	0	0	0		
1	0	0	0	0	0	0	0	0		
1	0	0	0	0	0	0	1	0		
1	0	0	0	1	0	0	0	0		
1	0	0	1	0	0	0	0	0		
1	0	1	0	0	0	0	0	0		
1	0	1	0	0	0	0	1	0		
1	0	1	0	1	0	0	0	0		
1	0	1	1	0	0	0	0	0		
1	1	0	0	0	0	0	0	0		
1	1	0	0	0	0	0	1	0		
1	1	0	0	1	0	0	0	0		
1	1	0	1	0	0	0	0	0		
1	1	0	1	0	0	0	1	0		
1	1	0	1	1	0	0	0	0		
1	1	1	0	0	0	0	0	0		
1	1	1	0	0	0	0	1	0		
1	1	1	0	1	0	0	0	0		
1	1	1	1	0	0	0	0	0		
1	1	1	1	0	0	0	1	0		
1	1	1	1	1	0	0	0	0		

ALPHANUMERIC  
DISPLAYS

### Recommended Operating Conditions

Parameter	Symbol	Minimum	Nominal	Maximum	Units
Supply Voltage	$V_{DD}$	4.5	5.0	5.5	V

## Electrical Characteristics over Operating Temperature Range (-45°C to +85°C)

4.5 V < V<sub>DD</sub> < 5.5 V, unless otherwise specified

Parameter	Symbol	T <sub>A</sub> = 25°C V <sub>DD</sub> = 5.0 V		-45°C < T <sub>A</sub> < +85°C 4.5 V < V <sub>DD</sub> < 5.5 V		Units	Test Conditions
		Typ.	Max.	Min.	Max.		
Input Leakage (Input without pullup)	I <sub>IH</sub> I <sub>IL</sub>				1.0 -1.0	μA	V <sub>IN</sub> = 0 to V <sub>DD</sub> , pins CLK, D <sub>0</sub> -D <sub>7</sub> , A <sub>0</sub> -A <sub>4</sub>
Input Current (Input with pullup)	I <sub>IPL</sub>	-11	-18		-30	μA	V <sub>IN</sub> = 0 to V <sub>DD</sub> , pins $\overline{\text{CLS}}$ , $\overline{\text{RST}}$ , $\overline{\text{WR}}$ , $\overline{\text{RD}}$ , $\overline{\text{CE}}$ , $\overline{\text{FL}}$
I <sub>DD</sub> Blank	I <sub>DD</sub> (BLK)	0.5	3.0		4.0	mA	V <sub>IN</sub> = V <sub>DD</sub>
I <sub>DD</sub> 8 digits 12 dots/character <sup>[1,2]</sup>	I <sub>DD</sub> (V)	200	255		330	mA	"V" on in all 8 locations
I <sub>DD</sub> 8 digits 20 dots/character <sup>[1,2,3,4]</sup>	I <sub>DD</sub> (#)	300	370		430	mA	"#" on in all locations
Input Voltage High	V <sub>IH</sub>			2.0	V <sub>DD</sub> +0.3	V	
Input Voltage Low	V <sub>IL</sub>			GND -0.3 V	0.8	V	
Output Voltage High	V <sub>OH</sub>			2.4		V	V <sub>DD</sub> = 4.5 V, I <sub>OH</sub> = -40 μA
Output Voltage Low D <sub>0</sub> -D <sub>7</sub>	V <sub>OL</sub>				0.4	V	V <sub>DD</sub> = 4.5 V, I <sub>OL</sub> = 1.6 mA
Output Voltage Low CLK	V <sub>OL</sub>				0.4	V	V <sub>DD</sub> = 4.5 V, I <sub>OL</sub> = 40 μA
High Level Output Current	I <sub>OH</sub>				-60	mA	V <sub>DD</sub> = 5.0 V
Low Level Output Current	I <sub>OL</sub>				50	mA	V <sub>DD</sub> = 5.0 V
Thermal Resistance IC Junction-to-Case	Rθ <sub>J-C</sub>	15				°C/W	

### Notes:

1. Average I<sub>DD</sub> measured at full brightness. See Table 2 in Control Word Section for I<sub>DD</sub> at lower brightness levels. Peak

$$I_{DD} = 28/15 \times I_{DD}(\#)$$

2. Maximum I<sub>DD</sub> occurs at -55°C.

3. Maximum I<sub>DD</sub>(#) = 355 mA at V<sub>DD</sub> = 5.25 V and IC T<sub>J</sub> = 150°C.

4. Maximum I<sub>DD</sub>(#) = 375 mA at V<sub>DD</sub> = 5.5 V and IC T<sub>J</sub> = 150°C.

## Optical Characteristics at 25°C<sup>[1]</sup>

V<sub>DD</sub> = 5.0 V at Full Brightness

Description	Part Number	Luminous Intensity Character Average (#) I <sub>v</sub> (mcd)		Peak Wavelength λ <sub>peak</sub> (nm)	Dominant Wavelength λ <sub>d</sub> (nm)
		Min.	Typ.		
AlGaAs	HDSP-2107	5.0	15.0	645	637
HER	HDSP-2112-2502	2.5	7.5	635	626
Orange	HDSP-2110-2500	2.5	7.5	600	602
Yellow	HDSP-2111-2501	2.5	7.5	583	585
High Performance Green	HDSP-2113-2503	2.5	7.5	568	574

Note: 1. Refers to the initial case temperature of the device immediately prior to measurement.

## AC Timing Characteristics over Temperature Range (-45°C to +85°C)

4.5 V < V<sub>DD</sub> < 5.5 V, unless otherwise specified

Reference Number	Symbol	Description	Min. <sup>[1]</sup>	Units
1	t <sub>ACC</sub>	Display Access Time Write Read	210 230	ns
2	t <sub>ACS</sub>	Address Setup Time to Chip Enable	10	ns
3	t <sub>CE</sub>	Chip Enable Active Time <sup>[2,3]</sup> Write Read	140 160	ns
4	t <sub>ACH</sub>	Address Hold Time to Chip Enable	20	ns
5	t <sub>CER</sub>	Chip Enable Recovery Time	60	ns
6	t <sub>CES</sub>	Chip Enable Active Prior to Rising Edge of <sup>[2,3]</sup> Write Read	140 160	ns
7	t <sub>CEH</sub>	Chip Enable Hold Time to Rising Edge of Read/Write Signal <sup>[2,3]</sup>	0	ns
8	t <sub>W</sub>	Write Active Time	100	ns
9	t <sub>WSU</sub>	Data Write Setup Time	50	ns
10	t <sub>WH</sub>	Data Write Hold Time	20	ns
11	t <sub>R</sub>	Chip Enable Active Prior to Valid Data	160	ns
12	t <sub>RD</sub>	Read Active Prior to Valid Data	75	ns
13	t <sub>DF</sub>	Read Data Float Delay	10	ns
	t <sub>RC</sub>	Reset Active Time <sup>[4]</sup>	300	ns

### Notes:

- Worst case values occur at an IC junction temperature of 150° C.
- For designers who do not need to read from the display, the Read line can be tied to V<sub>DD</sub> and the Write and Chip Enable lines can be tied together.
- Changing the logic levels of the Address lines when  $\overline{CE}$  = "0" may cause erroneous data to be entered into the Character RAM, regardless of the logic levels of the  $\overline{WR}$  and  $\overline{RD}$  lines.
- The display must not be accessed until after 3 clock pulses (110 μs min. using the internal refresh clock) after the rising edge of the reset line.

## AC Timing Characteristics over Temperature Range (-45°C to +85°C)

4.5 V < V<sub>DD</sub> < 5.5 V, unless otherwise specified

Symbol	Description	25°C Typ.	Min. <sup>[1]</sup>	Units
F <sub>OSC</sub>	Oscillator Frequency	57	28	kHz
F <sub>RF</sub> <sup>[2]</sup>	Display Refresh Rate	256	128	Hz
F <sub>FL</sub> <sup>[3]</sup>	Character Flash Rate	2	1	Hz
t <sub>ST</sub> <sup>[4]</sup>	Self Test Cycle Time	4.6	9.2	sec

### Notes:

1. Worst case values occur at an IC junction temperature of 150°C.

2.  $F_{RF} = F_{OSC}/224$

3.  $F_{FL} = F_{OSC}/28,672$

4.  $t_{ST} = 262,144/F_{OSC}$

## Write Cycle Timing Diagram

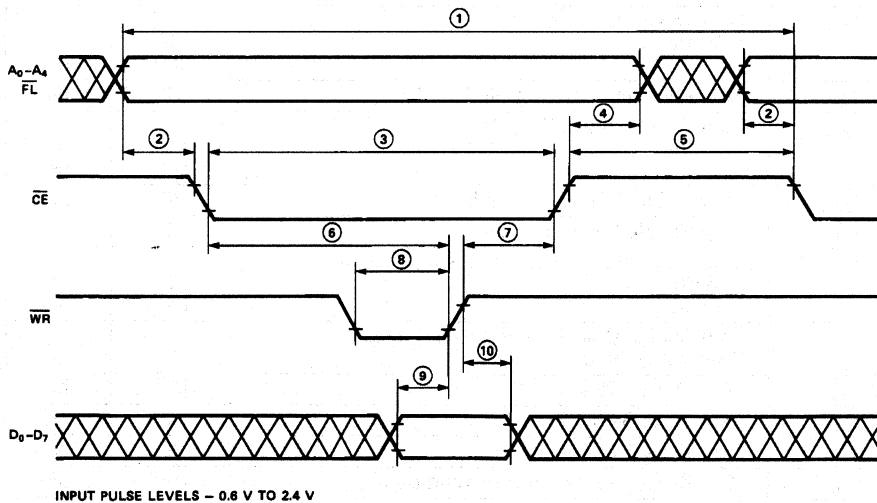

## Read Cycle Timing Diagram

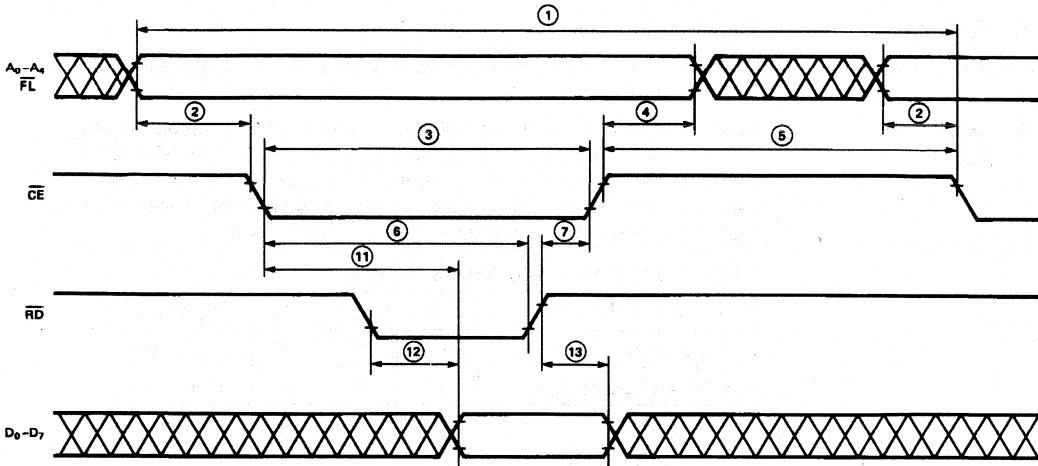

INPUT PULSE LEVELS: 0.6 V TO 2.4 V  
 OUTPUT REFERENCE LEVELS: 0.6 V TO 2.2 V  
 OUTPUT LOADING = 1 TTL LOAD AND 100pFd

ALPHANUMERIC  
 DISPLAYS

## Relative Luminous Intensity vs. Temperature

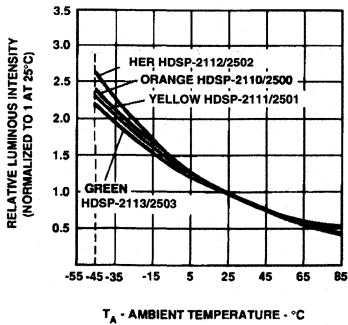

## Electrical Description

### Pin Function

RESET ( $\overline{\text{RST}}$ , pin 1)

FLASH ( $\overline{\text{FL}}$ , pin 2)

ADDRESS INPUTS  
( $A_0$ - $A_4$ , pins 3-6, 10)

### Description

Initializes the display.

$\overline{\text{FL}}$  low indicates an access to the Flash RAM and is unaffected by the state of address lines  $A_3$ - $A_4$ .

Each location in memory has a distinct address. Address inputs ( $A_0$ - $A_2$ ) select a specific location in the Character RAM, the Flash RAM or a particular row in the UDC (User-Defined Character) RAM.  $A_3$ - $A_4$  are used to select which section of memory is accessed. Table 1 shows the logic levels needed to access each section of memory.

**Table 1. Logic Levels to Access Memory**

Section of Memory	$\overline{\text{FL}}$	$A_4$	$A_3$	$A_2$ $A_1$ $A_0$
Flash RAM	0	X	X	Char. Address
UDC Address Register	1	0	0	Don't Care
UDC RAM	1	0	1	Row Address
Control Word Register	1	1	0	Don't Care
Character RAM	1	1	1	Character Address

CLOCK SELECT  
(CLS, pin 11)

Used to select either an internal (CLS = 1) or external (CLS = 0) clock source.

CLOCK INPUT/OUTPUT  
(CLK, pin 12)

Outputs the master clock (CLS = 1) or inputs a clock (CLS = 0) for slave displays.

WRITE ( $\overline{\text{WR}}$ , pin 13)

Data is written into the display when the  $\overline{\text{WR}}$  input is low and the  $\overline{\text{CE}}$  input is low.

CHIP ENABLE ( $\overline{\text{CE}}$ , pin 17)

Must be at a logic low to read or write data to the display and must go high between each read and write cycle.

READ ( $\overline{\text{RD}}$ , pin 18)

Data is read from the display when the  $\overline{\text{RD}}$  input is low and the  $\overline{\text{CE}}$  input is low.

DATA Bus ( $D_0$ - $D_7$ ,  
pins 19, 20, 23-28)

Used to read from or write to the display.

GND (SUPPLY) (pin 15)

Analog ground for the LED drivers.

GND (LOGIC) (pin 16)

Digital ground for internal logic.

$V_{\text{DD}}$  (POWER) (pin 14)

Positive power supply input.



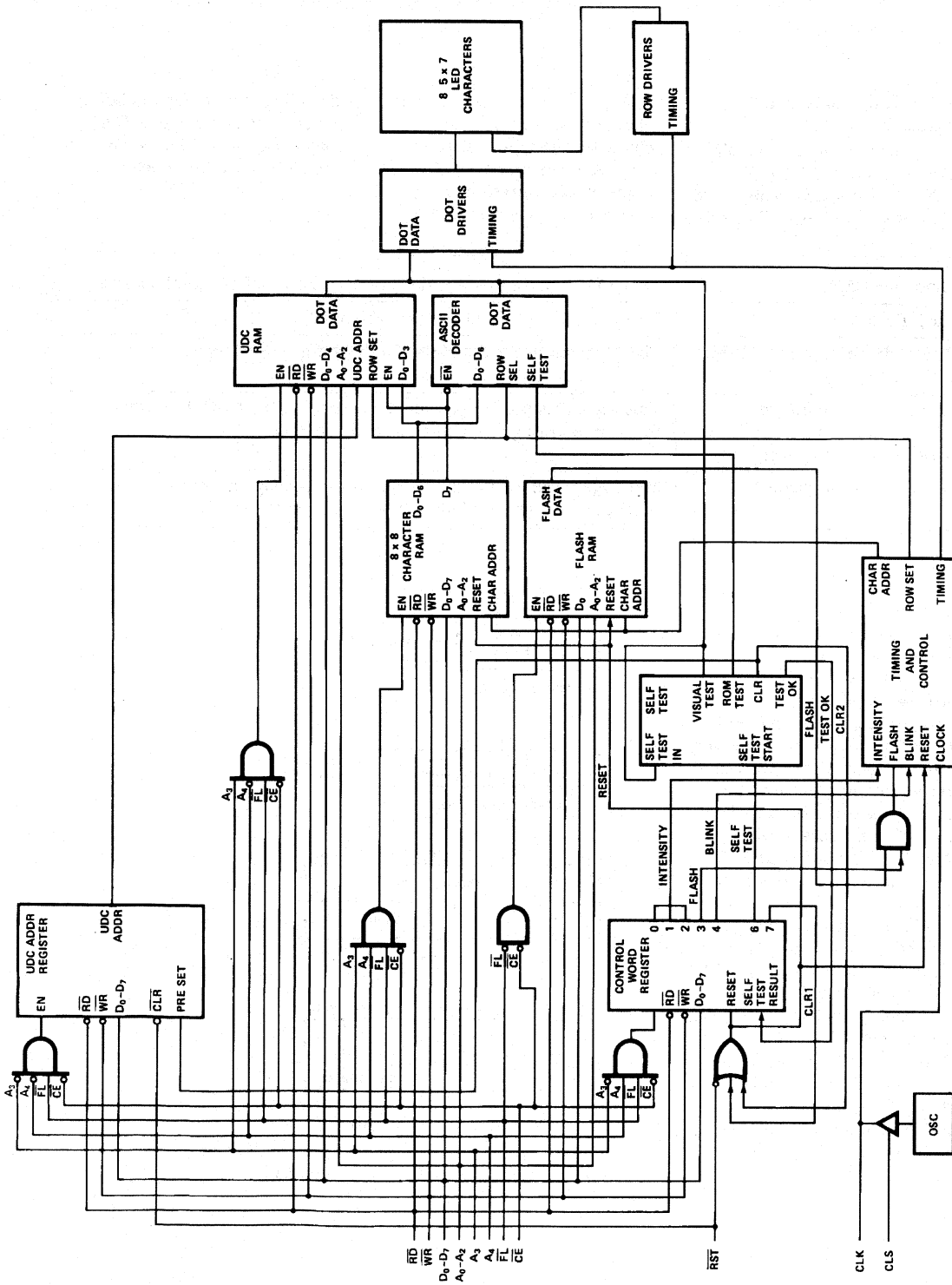

Figure 1. HDSP-210X/211X/212X/250X Internal Block Diagram.

ALPHANUMERIC  
DISPLAYS

### Display Internal Block Diagram

Figure 1 shows the internal block diagram of the HDSP-210X/-211X/-250X displays. The CMOS IC consists of an 8 byte Character

RAM, an 8 bit Flash RAM, a 128 character ASCII decoder, a 16 character UDC RAM, a UDC Address Register, a Control Word Register, and refresh circuitry necessary to synchronize the

decoding and driving of eight 5 x 7 dot matrix characters. The major user-accessible portions of the display are listed below:

Character RAM	This RAM stores either ASCII character data or a UDC RAM address.
Flash RAM	This is a 1 x 8 RAM which stores Flash data.
User-Defined Character RAM (UDC RAM)	This RAM stores the dot pattern for custom characters.
User-Defined Character Address Register (UDC Address Register)	This register is used to provide the address to the UDC RAM when the user is writing or reading a custom character.
Control Word Register	This register allows the user to adjust the display brightness, flash individual characters, blink, self test, or clear the display.

### Character Ram

Figure 2 shows the logic levels needed to access the HDSP-210X/-211X/-250X Character RAM. During a normal access, the  $\overline{CE}$  = "0" and either  $\overline{RD}$  = "0" or  $\overline{WR}$  = "0." However, erroneous data may be written into the Character RAM if the address lines are unstable when  $\overline{CE}$  = "0" regardless of the logic levels of the  $\overline{RD}$  or  $\overline{WR}$  lines. Address lines  $A_0$ - $A_2$  are used to select the location in the Character RAM. Two types of data can be stored in each Character RAM location: an ASCII code or a UDC RAM address. Data bit  $D_7$  is used to differentiate between the ASCII character and a UDC RAM address.  $D_7 = 0$  enables the ASCII decoder and  $D_7 = 1$  enables the UDC RAM.  $D_0$ - $D_6$  are used to input ASCII data and  $D_0$ - $D_3$  are used to input a UDC address.

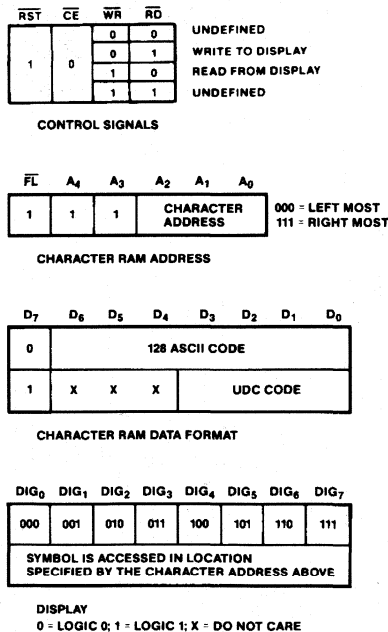

Figure 2. Logic Levels to Access the Character RAM.

### UDC RAM and UDC Address Register

Figure 3 shows the logic levels needed to access the UDC RAM and the UDC Address Register. The UDC Address Register is eight bits wide. The lower four bits (D<sub>0</sub>-D<sub>3</sub>) are used to select one of the 16 UDC locations. The upper four bits (D<sub>4</sub>-D<sub>7</sub>) are not used. Once the UDC address has been stored in the UDC Address Register, the UDC RAM can be accessed.

To completely specify a 5 x 7 character, eight write cycles are required. One cycle is used to store the UDC RAM address in the UDC Address Register and seven cycles are used to store dot data in the UDC RAM. Data is entered by rows and one cycle is needed to access each row. Figure 4 shows the organization of a UDC character assuming the symbol to be stored is an "F." A<sub>0</sub>-A<sub>2</sub> are used to select the row to be accessed and D<sub>0</sub>-D<sub>4</sub> are used to transmit the row dot data. The upper three bits (D<sub>5</sub>-D<sub>7</sub>) are ignored. D<sub>0</sub> (least significant bit) corresponds to the right most column of the 5 x 7 matrix and D<sub>4</sub> (most significant bit) corresponds to the left most column of the 5 x 7 matrix.

### Flash RAM

Figure 5 shows the logic levels needed to access the Flash RAM. The Flash RAM has one bit associated with each location of the Character RAM. The Flash input is used to select the Flash RAM while address lines A<sub>3</sub>-A<sub>4</sub> are ignored. Address lines A<sub>0</sub>-A<sub>2</sub> are used to select the location in the Flash RAM to store the attribute. D<sub>0</sub> is used to store or remove the flash attribute. D<sub>0</sub> = "1" stores the attribute and D<sub>0</sub> = "0" removes the attribute.

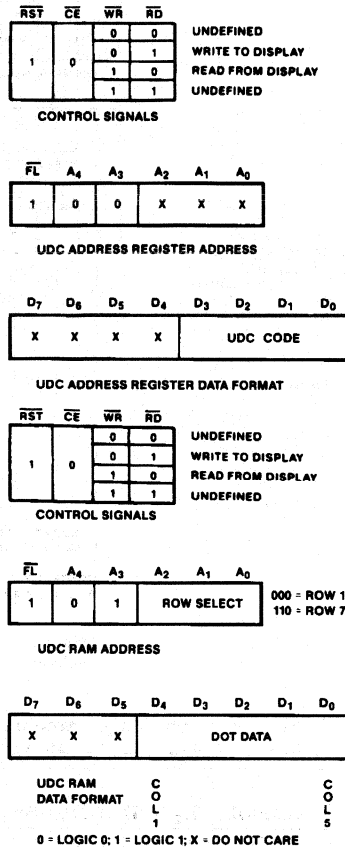

Figure 3. Logic Levels to Access a UDC Character.

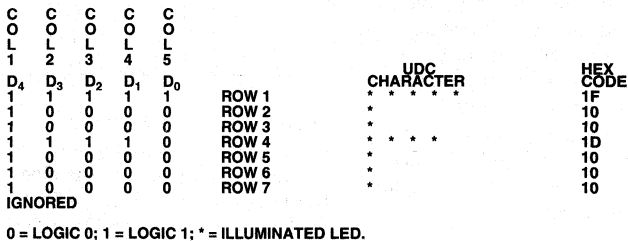

Figure 4. Data to Load "F" into the UDC RAM.

When the attribute is enabled through bit 3 of the Control Word and a "1" is stored in the Flash RAM, the corresponding character will flash at approxi-

mately 2 Hz. The actual rate is dependent on the clock frequency. For an external clock the flash rate can be calculated by dividing the clock frequency by 28,672.

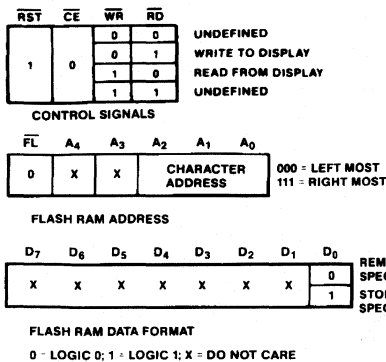

Figure 5. Logic Levels to Access the Flash RAM.

### Control Word Register

Figure 6 shows how to access the Control Word Register. This 8-bit register performs five functions: Brightness control, Flash RAM control, Blinking, Self Test, and Clear. Each function is independent of the others; however, all bits are updated during each Control Word write cycle.

#### Brightness (Bits 0-2)

Bits 0-2 of the Control Word adjust the brightness of the display. Bits 0-2 are interpreted as a three bit binary code with code (000) corresponding to maximum brightness and code (111) corresponding to a blanked display. In addition to varying the display brightness, bits 0-2 also vary the average value of  $I_{DD}$ .  $I_{DD}$  can be calculated at any brightness level by multiplying the percent brightness level by the value of  $I_{DD}$  at the 100% brightness level. These values of  $I_{DD}$  are shown in Table 2.

#### Flash Function (Bit 3)

Bit 3 determines whether the flashing character attribute is on or off. When bit 3 is a "1," the output of the Flash RAM is checked. If the content of a location in the Flash RAM is a "1," the associated digit will flash at

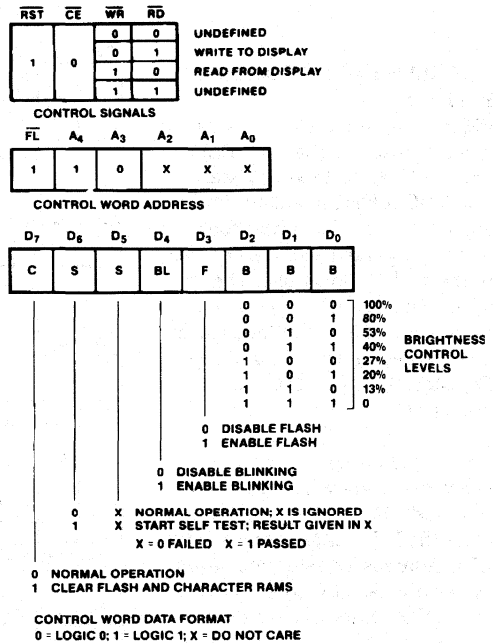

Figure 6. Logic Levels to Access the Control Word Register

Table 2. Current Requirements at Different Brightness Levels  $V_{DD} = 5.0$  V

Symbol	D <sub>2</sub>	D <sub>1</sub>	D <sub>0</sub>	% Brightness	Current at 25°C Typ.	Units
$I_{DD}$ (V)	0	0	0	100	200	mA
	0	0	1	80	160	mA
	0	1	0	53	106	mA
	0	1	1	40	80	mA
	1	0	0	27	54	mA
	1	0	1	20	40	mA
	1	1	0	13	26	mA

approximately 2 Hz. For an external clock, the blink rate can be calculated by driving the clock frequency by 28,672. If the flash enable bit of the Control Word is a "0," the content of the Flash RAM is ignored. To use this function with multiple display systems, see the Display Reset section.

#### Blink Function (Bit 4)

Bit 4 of the Control Word is used to synchronize blinking of all

eight digits of the display. When this bit is a "1" all eight digits of the display will blink at approximately 2 Hz. The actual rate is dependent on the clock frequency. For an external clock, the blink rate can be calculated by dividing the clock frequency by 28,672. This function will override the Flash function when it is active. To use this function with multiple display systems, see the Display Reset section.

**Self Test Function (Bits 5, 6)**

Bit 6 of the Control Word Register is used to initiate the self test function. Results of the internal self test are stored in bit 5 of the Control Word. Bit 5 is a read only bit where bit 5 = "1" indicates a passed self test and bit 5 = "0" indicates a failed self test.

Setting bit 6 to a logic 1 will start the self test function. The built-in self test function of the IC consists of two internal routines which exercise major portions of the IC and illuminate all of the LEDs. The first routine cycles the ASCII decoder ROM through all states and performs a checksum on the output. If the checksum agrees with the correct value, bit 5 is set to "1." The second routine provides a visual test of the LEDs using the drive circuitry. This is accomplished by writing checkered and inverse checkered patterns to the display. Each pattern is displayed for approximately 2 seconds.

During the self test function the display must not be accessed. The time needed to execute the self test function is calculated by multiplying the clock period by 262,144. For example, assume a clock frequency of 58 KHz, then the time to execute the self test function frequency is equal to  $(262,144/58,000) = 4.5$  second duration.

At the end of the self test function, the Character RAM is loaded with blanks, the Control Word Register is set to zeros except for bit 5, the Flash RAM is cleared, and the UDC Address Register is set to all ones.

**Clear Function (Bit 7)**

Bit 7 of the Control Word will clear the Character RAM and the Flash RAM. Setting bit 7 to a "1" will start the clear function. Three clock cycles (110 ms minimum using the internal refresh clock) are required to complete the clear function. The display must not be accessed while the display is being cleared. When the clear function has been completed, bit 7 will be reset to a "0." The ASCII character code for a space (20H) will be loaded into the Character RAM to blank the display and the Flash RAM will be loaded with "0"s. The UDC RAM, UDC Address Register, and the remainder of the Control Word are unaffected.

**Display Reset**

Figure 7 shows the logic levels needed to Reset the display. The display should be Reset on Power-up. The external Reset clears the Character RAM, Flash RAM, Control Word and resets the internal counters. After the rising edge of the Reset signal, three clock cycles (110  $\mu$ s minimum using the internal refresh clock) are required to complete the reset sequence. The display must not be accessed while the display is being reset. The ASCII Character code for a

$\overline{\text{RST}}$	$\overline{\text{CE}}$	$\overline{\text{WR}}$	$\overline{\text{RD}}$	$\overline{\text{FL}}$	$A_4-A_0$	$D_7-D_0$
0	1	X	X	X	X	X

0 - LOGIC 0; 1 - LOGIC 1; X - DO NOT CARE  
NOTE:  
IF RST, CE AND WR ARE LOW, UNKNOWN  
DATA MAY BE WRITTEN INTO THE DISPLAY.

**Figure 7. Logic Levels to Reset the Display.**

space (20H) will be loaded into the Character RAM to blank the display. The Flash RAM and Control Word Register are loaded with all "0"s. The UDC RAM and UDC Address Register are unaffected. All displays which operate with the same clock source must be simultaneously reset to synchronize the Flashing and Blinking functions.

**Mechanical and Electrical Considerations**

The HDSP-210X/-211X/-250X are 28 pin dual-in-line packages with 26 external pins. The devices can be stacked horizontally and vertically to create arrays of any size. The HDSP-210X/-211X/-250X are designed to operate continuously from -45°C to +85°C with a maximum of 20 dots on per character at 5.25 V. Illuminating all thirty-five dots at full brightness is not recommended.

The HDSP-210X/-211X/-250X are assembled by die attaching and wire bonding 280 LED chips and a CMOS IC to a thermally conductive printed circuit board. A polycarbonate lens is placed over the PC board creating an air gap over the LED wire bonds. A protective cap creates an air gap over the CMOS IC. Backfill epoxy environmentally seals the display package. This package construction makes the display highly tolerant to temperature cycling and allows wave soldering.

The inputs to the IC are protected against static discharge and input current latchup. However, for best results standard CMOS handling precautions should be

used. Prior to use, the HDSP-210X/-211X/-250X should be stored in antistatic tubes or in conductive material. During assembly, a grounded conductive work area should be used, and assembly personnel should wear conductive wrist straps. Lab coats made of synthetic material should be avoided since they are prone to static buildup. Input current latchup is caused when the CMOS inputs are subjected to either a voltage below ground ( $V_{IN} < \text{ground}$ ) or to a voltage higher than  $V_{DD}$  ( $V_{IN} > V_{DD}$ ) and when a high current is forced into the input. To prevent input current latchup and ESD damage, unused inputs should be connected either to ground or to  $V_{DD}$ . Voltages should not be applied to the inputs until  $V_{DD}$  has been applied to the display.

### Thermal Considerations

The HDSP-210X/-211X/250X have been designed to provide a low thermal resistance path for the CMOS IC to the 26 package pins. Heat is typically conducted through the traces of the printed circuit board to free air. For most applications no additional heatsinking is required.

Measurements were made on a 32 character display string to determine the thermal resistance of the display assembly. Several display boards were constructed using 0.062 in. thick printed circuit material, and one ounce copper 0.020 in. traces. Some of the device pins were connected to a heatsink formed by etching a copper area on the printed circuit board surrounding the display. A maximally metallized printed circuit board was also evaluated.

The junction temperature was measured for displays soldered directly to these PC boards, displays installed in sockets, and finally displays installed in sockets with a filter over the display to restrict airflow. The results of these thermal resistance measurements,  $R\theta_{J-A}$  are shown in Table 3 and include the effects of  $R\theta_{J-C}$ .

### Ground Connections

Two ground pins are provided to keep the internal IC logic ground clean. The designer can, when necessary, route the analog ground for the LED drivers separately from the logic ground until an appropriate ground plane is available. On long interconnections between the display and the host system, the designer can keep voltage drops on the analog ground from affecting the display logic levels by isolating the two grounds.

The logic ground should be connected to the same ground potential as the logic interface circuitry. The analog ground and the logic ground should be connected at a common ground

which can withstand the current introduced by the switching LED drivers. When separate ground connections are used, the analog ground can vary from -0.3 V to +0.3 V with respect to the logic ground. Voltage below -0.3 V can cause all dots to be on. Voltage above +0.3 V can cause dimming and dot mismatch.

### Soldering and Post Solder Cleaning Instructions for the HDSP-210X/-211X/-250X

The HDSP-210X/-211X/-250X may be hand soldered or wave soldered with SN63 solder. When hand soldering, it is recommended that an electronically temperature controlled and securely grounded soldering iron be used. For best results, the iron tip temperature should be set at 315°C (600°F). For wave soldering, a rosin-based RMA flux can be used. The solder wave temperature should be set at 245°C ± 5°C (473°F ± 9°F), and the dwell in the wave should be set between 1½ to 3 seconds for optimum soldering. The preheat temperature should not exceed 105°C (221°F) as measured on the solder side of the PC board.

**Table 3. Thermal Resistance,  $\theta_{JA}$ , Using Various Amounts of Heatsinking Material**

Heatsinking Metal per Device sq. in.	W/Sockets W/O Filter (Avg.)	W/O Sockets W/O Filter (Avg.)	W/Sockets W/Filter (Avg.)	Units
0	31	30	35	°C/W
1	31	28	33	°C/W
3	30	26	33	°C/W
Max. Metal	29	25	32	°C/W
4 Board Avg	30	27	33	°C/W

For additional information on soldering and post solder cleaning, see Application Note 1027, *Soldering LED Components*.

### **Contrast Enhancement**

The objective of contrast enhancement is to provide good readability in a variety of ambient lighting conditions. For information on contrast enhancement see Application Note 1015, *Contrast Enhancement Techniques for LED Displays*.

# CMOS 5 x 7 Alphanumeric Displays

## Technical Data

### HCMS-200X Series HCMS-230X Series

#### Features

- **On-Board Low Power CMOS IC:**  
Integrated Shift Register with Constant Current LED Drivers
- **Wide Operating Temperature Range:**  
-40°C to +85°C
- **Compact Glass Ceramic 4 Character Package:**  
HCMS-200X Series End Stackable  
HCMS-230X Series X-Y Stackable
- **Five Colors:**  
Standard Red  
High Efficiency Red  
Orange  
Yellow  
High Performance Green
- **5 X 7 LED Matrix Displays Full ASCII Set**
- **Two Character Heights:**  
3.8mm (0.15 inch)  
5.0mm (0.20 inch)
- **Wide Viewing Angle:**  
X Axis =  $\pm 50^\circ$   
Y Axis =  $\pm 65^\circ$
- **Long Viewing Distance:**  
HCMS-200X Series to 2.6 Meters (8.6 Feet)  
HCMS-230X Series to 3.5 Meters (11.5 Feet)
- **Categorized for Luminous Intensity**

- **HCMS-2001/-2003, HCMS-2301/-2303:**  
Categorized for Color

#### Typical Applications

- Commercial Avionics
- Instrumentation
- Medical Instruments
- Business Machines

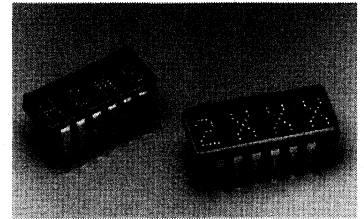

#### Description

The HCMS-200X and HCMS-230X series are 5x7 LED four character displays contained in 12 pin dual-in-line packages designed for displaying alphanumeric information. The character height for the HCMS-200X series displays is 3.8mm (0.15 inch), and for the

HCMS-230X series displays the character height is 5.0mm (0.20 inch). These displays are available in five LED colors: standard red, high efficiency red, orange, yellow and high performance green. The HCMS-200X series displays are end stackable and the HCMS-230X series displays are end/row stackable.

#### Display Selection Table

Part Number	Character Size	LED Color
HCMS-2000	3.8 mm (0.15 inch)	Standard Red
HCMS-2001	3.8 mm (0.15 inch)	Yellow
HCMS-2002	3.8 mm (0.15 inch)	High-Efficiency Red
HCMS-2003	3.8 mm (0.15 inch)	High-Performance Green
HCMS-2004	3.8 mm (0.15 inch)	Orange
HCMS-2300	5.0 mm (0.20 inch)	Standard Red
HCMS-2301	5.0 mm (0.20 inch)	Yellow
HCMS-2302	5.0 mm (0.20 inch)	High-Efficiency Red
HCMS-2303	5.0 mm (0.20 inch)	High-Performance Green
HCMS-2304	5.0 mm (0.20 inch)	Orange

ESD WARNING: STANDARD CMOS HANDLING PRECAUTIONS SHOULD BE OBSERVED.



These displays are designed with on-board CMOS integrated circuits for use in applications where conservation of power is important. The two CMOS ICs form an on-board serial-in-parallel-out 28-bit shift register with constant current output LED row drivers. Decoded column data is clocked into the on-board shift register for

each refresh cycle. Full character display is achieved with external column strobing.

**Compatibility with HDSP-200X/230X TTL IC Series Displays**

The HCMS-200X, HCMS-230X CMOS IC displays are "drop-in" replacements for the equivalent

HDSP-200X, HDSP-230X TTL IC displays. The 12 pin glass/ceramic package configuration, four digit character matrix and pin functions are identical.

**Package Dimensions**

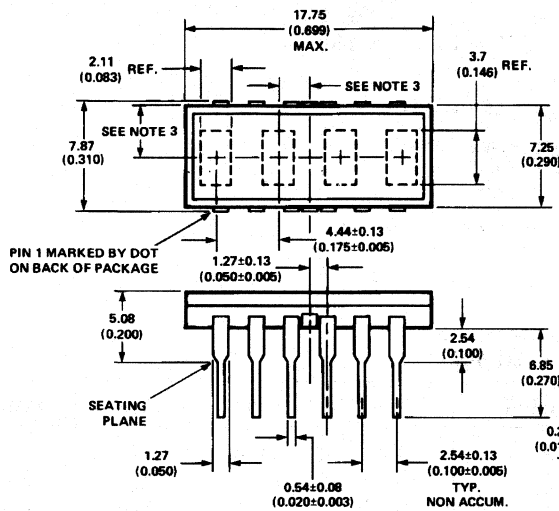

PIN	FUNCTION	PIN	FUNCTION
1	COLUMN 1	7	DATA OUT
2	COLUMN 2	8	V <sub>B</sub>
3	COLUMN 3	9	V <sub>DD</sub>
4	COLUMN 4	10	CLOCK
5	COLUMN 5	11	GROUND
6	INT. CONNECT*	12	DATA IN

\* DO NOT CONNECT OR USE

ALPHANUMERIC DISPLAYS

**HCMS-200X Series**

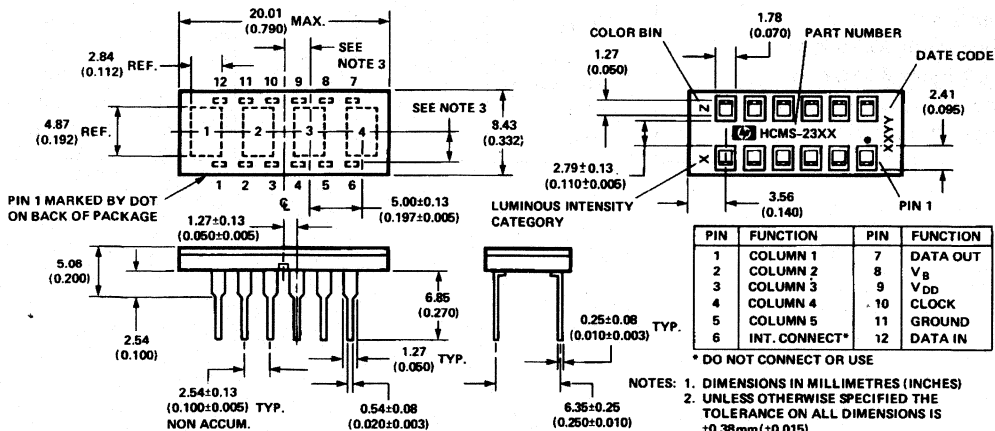

PIN	FUNCTION	PIN	FUNCTION
1	COLUMN 1	7	DATA OUT
2	COLUMN 2	8	V <sub>B</sub>
3	COLUMN 3	9	V <sub>DD</sub>
4	COLUMN 4	10	CLOCK
5	COLUMN 5	11	GROUND
6	INT. CONNECT*	12	DATA IN

\* DO NOT CONNECT OR USE

- NOTES:
1. DIMENSIONS IN MILLIMETRES (INCHES)
  2. UNLESS OTHERWISE SPECIFIED THE TOLERANCE ON ALL DIMENSIONS IS ±0.38mm (±0.015).
  3. CHARACTERS ARE CENTERED WITH RESPECT TO LEADS WITHIN ±0.13mm (±0.005").
  4. LEAD MATERIAL IS COPPER ALLOY, SOLDER DIPPED.

**HCMS-230X Series**

### Absolute Maximum Ratings

Supply Voltage $V_{DD}$ to Ground .....	-0.3 V to 7.0 V
Data Input, Data Output, $V_B$ .....	-0.3 V to $V_{DD}$
Column Input Voltage, $V_{COL}$ .....	-0.3 V to $V_{DD}$
Free Air Operating Temperature Range, $T_A$ .....	-40°C to +85°C
Storage Temperature Range, $T_S$ .....	-55°C to +100°C
Maximum Allowable Package Power Dissipation, $P_D$ <sup>[1,2]</sup>	
HCMS-2000/-2001/-2002/-2003/-2004 at $T_A = 78^\circ\text{C}$ .....	0.79 Watts
HCMS-2300 at $T_A = 85^\circ\text{C}$ .....	0.79 Watts
HCMS-2301/-2302/-2303/-2304 at $T_A = 85^\circ\text{C}$ .....	0.92 Watts
Maximum Solder Temperature	
1.59 mm (0.063") Below Seating Plane, $t < 5$ sec .....	260°C
ESD Protection @ 1.5 k $\Omega$ , 100 pF .....	$V_z = 4$ kV (each pin)

#### Notes:

- Maximum allowable power dissipation is derived from  $V_{DD} = 5.25$  V,  $V_B = 2.4$  V,  $V_{COL} = 3.5$  V, 20 LEDs on per character, 20% DF.
- The power dissipation for these displays should be derated as follows:  
 HCMS-200X series derate above 78°C at 18 mW/°C,  $R\theta_{JA} = 60^\circ\text{C/W}$ .  
 HCMS-230X series may be operated without derating up to  $T_A = 85^\circ\text{C}$ ,  
 $R\theta_{JA} = 45^\circ\text{C/W}$ .  
 Deratings based on  $R\theta_{PCA} = 35^\circ\text{C/W}$  per display for printed circuit board assembly. See Figure 1 for power derating.

### Recommended Operating Conditions over Operating Temperature Range (-40°C to +85°C)

Parameter	Symbol	Min.	Typ.	Max.	Units
Supply Voltage	$V_{DD}$	4.75	5.00	5.25	V
Data Out Current, Low State	$I_{OL}$			1.6	mA
Data Out Current, High State	$I_{OH}$			-0.5	mA
Column Input Voltage	$V_{COL}$	2.75	3.0	3.5	V
Setup Time	$t_{SETUP}$	10			ns
Hold Time	$t_{HOLD}$	25			ns
Clock Pulse Width High	$t_{WH(CLOCK)}$	50			ns
Clock Pulse Width Low	$t_{WL(CLOCK)}$	50			ns
Clock High to Low Transition	$t_{THL}$			200	ns
Clock Frequency	$f_{CLOCK}$			5	MHz

### Electrical Characteristics over Operating Temperature Range (-40°C to +85°C)

Parameter	Symbol	Test Conditions	Min.	Typ.*	Max.	Units
Supply Current, Dynamic <sup>[1]</sup>	$I_{DD}$	$f_{CLOCK} = 5 \text{ MHz}$		6.2	7.8	mA
Supply Current, Static <sup>[2]</sup>	$I_{DD\text{Soff}}$ $I_{DD\text{Son}}$	$V_B = 0.4 \text{ V}$ $V_B = 2.4 \text{ V}$		1.8 2.2	2.6 6.0	mA
Column Input Current	$I_{COL}$	$V_B = 0.4 \text{ V}$			10	$\mu\text{A}$
HCMS-2000/-2001/-2002/-2003/-2004		$V_B = 2.4 \text{ V}$		310	384	mA
HCMS-2300		$V_B = 2.4 \text{ V}$		310	384	
HCMS-2301/-2302/-2303/-2304		$V_B = 2.4 \text{ V}$		360	451	
Input Logic High Data, $V_B$ , Clock	$V_{IH}$	$V_{DD} = 4.75 \text{ V}$	2.0			V
Input Logic Low Data, $V_B$ , Clock	$V_{IL}$	$V_{DD} = 5.25 \text{ V}$			0.8	V
Input Current Data, Clock $V_B$	$I_I$	$V_{DD} = 5.25 \text{ V}$ $0 < V_I < 5.25 \text{ V}$ $0 < V_B < 5.25 \text{ V}$	-10 -40		+1 0	$\mu\text{A}$
Data Out Voltage	$V_{OH}$	$V_{DD} = 4.75 \text{ V}$ $I_{OH} = -0.5 \text{ mA}$ $I_{COL} = 0 \text{ mA}$	2.4	4.2		V
	$V_{OL}$	$V_{DD} = 5.25 \text{ V}$ $I_{OL} = 1.6 \text{ mA}$ $I_{COL} = 0 \text{ mA}$		0.2	0.4	V
Power Dissipation Per Package <sup>[3]</sup>	$P_D$	$V_{DD} = 5.0 \text{ V}$ $V_{COL} = 3.5 \text{ V}$ 17.5% DF		414		mW
HCMS-2000/-2001/-2002/-2003/-2004		$V_B = 2.4 \text{ V}$		414		
HCMS-2300		15 LEDs ON		481		
HCMS-2301/-2302/-2303/-2304		per Character				
Thermal Resistance IC Junction-to-Pin <sup>[4]</sup>	$R\theta_{J-PIN}$			25		$^{\circ}\text{C/W}$
HCMS-2000/-2001/-2002/-2003/-2004				10		
HCMS-2300/-2301/-2302/-2303/-2304						

\*All typical values specified at  $V_{DD} = 5.0 \text{ V}$  and  $T_A = 25^{\circ}\text{C}$ .

#### Notes:

- $I_{DD}$  Dynamic is the IC current while clocking column data through the on-board shift register at a clock frequency of 5MHz, the display is not illuminated.
- $I_{DD}$  Static is the IC current after column data is loaded and not being clocked through the on-board shift register.
- Four characters are illuminated with a typical ASCII character composed of 15 dots per character.
- IC junction temperature  $T_J(\text{IC}) = (P_D)(R\theta_{J-PIN} + R\theta_{PC-A}) + T_A$ .

## Optical Characteristics at $T_A = 25^\circ\text{C}$

### Standard Red HCMS-2000/-2300

Description	Symbol	Test Condition	Min.	Typ.*	Max.	Units
Peak Luminous Intensity per LED <sup>(5,9)</sup> HCMS-2000 HCMS-2300 (Character Average)	$I_{\nu\text{PEAK}}$	$V_{\text{DD}} = 5.0\text{ V}$ $V_{\text{COL}} = 3.5\text{ V}$ $V_{\text{B}} = 2.4\text{ V}$ $T_i = 25^\circ\text{C}^{(7)}$	105 130	200 300		$\mu\text{cd}$
Dominant Wavelength <sup>(6)</sup>	$\lambda_d$			639		nm
Peak Wavelength	$\lambda_{\text{PEAK}}$			655		nm

### Yellow HCMS-2001/-2301

Description	Symbol	Test Condition	Min.	Typ.*	Max.	Units
Peak Luminous Intensity per LED <sup>(5,9)</sup> HCMS-2001 HCMS-2301 (Character Average)	$I_{\nu\text{PEAK}}$	$V_{\text{DD}} = 5.0\text{ V}$ $V_{\text{COL}} = 3.5\text{ V}$ $V_{\text{B}} = 2.4\text{ V}$ $T_i = 25^\circ\text{C}^{(7)}$	400 650	750 1140		$\mu\text{cd}$
Dominant Wavelength <sup>(6,8)</sup>	$\lambda_d$			585		nm
Peak Wavelength	$\lambda_{\text{PEAK}}$			583		nm

### High Efficiency Red HCMS-2002/-2302

Description	Symbol	Test Condition	Min.	Typ.*	Max.	Unit
Peak Luminous Intensity per LED <sup>(5,9)</sup> HCMS-2002 HCMS-2302 (Character Average)	$I_{\nu\text{PEAK}}$	$V_{\text{DD}} = 5.0\text{ V}$ $V_{\text{COL}} = 3.5\text{ V}$ $V_{\text{B}} = 2.4\text{ V}$ $T_i = 25^\circ\text{C}^{(7)}$	400 650	1430 1430		$\mu\text{cd}$
Dominant Wavelength <sup>(6)</sup>	$\lambda_d$			625		nm
Peak Wavelength	$\lambda_{\text{PEAK}}$			635		nm

### High Performance Green HCMS-2003/-2303

Description	Symbol	Test Condition	Min.	Typ.*	Max.	Units
Peak Luminous Intensity per LED <sup>(5,9)</sup> HCMS-2003 HCMS-2303 (Character Average)	$I_{\nu\text{PEAK}}$	$V_{\text{DD}} = 5.0\text{ V}$ $V_{\text{COL}} = 3.5\text{ V}$ $V_{\text{B}} = 2.4\text{ V}$ $T_i = 25^\circ\text{C}^{(7)}$	850 1280	1550 2410		$\mu\text{cd}$
Dominant Wavelength <sup>(6,8)</sup>	$\lambda_d$			574		nm
Peak Wavelength	$\lambda_{\text{PEAK}}$			568		nm

## Orange HCMS-2004/-2304

Description	Symbol	Test Condition	Min.	Typ.*	Max.	Units
Peak Luminous Intensity per HCMS-2004 LED <sup>(5,9)</sup> HCMS-2304 (Character Average)	$I_{VPEAK}$	$V_{DD} = 5.0\text{ V}$ $V_{COL} = 3.5\text{ V}$ $V_B = 2.4\text{ V}$ $T_A = 25^\circ\text{C}^{(7)}$	400 650	1430 1430		$\mu\text{cd}$
Dominant Wavelength <sup>(8)</sup>	$\lambda_d$			602		nm
Peak Wavelength	$\lambda_{PEAK}$			600		nm

\*All typical values specified at  $V_{DD} = 5.0\text{ V}$  and  $T_A = 25^\circ\text{C}$  unless otherwise noted.

### Notes:

- These LED displays are categorized for luminous intensity, with the intensity category designated by a letter code on the back of the package.
- The HCMS-2001/-2301 and HCMS-2003/-2303 are categorized for color with the color category designated by a number on the back of the package.
- $T_i$  refers to the initial case temperature of the display immediately prior to the light measurement.
- Dominant wavelength,  $\lambda_d$ , is derived from the CIE Chromaticity Diagram, and represents the single wavelength which defines the color of the device.
- The luminous sterance of the individual LED pixels may be calculated using the following equations:

$$L_v(\text{cd/m}^2) = I_v(\text{Candela}) * \text{DF/A}(\text{Metre})^2$$

$$L_v(\text{Footlamberts}) = pI_v(\text{Candela}) * \text{DF/A}(\text{Foot})^2$$

Where: A = LED pixel area =  $5.3 \times 10^{-8}\text{M}^2$  or  $5.8 \times 10^{-7}\text{ft}^2$   
DF = LED on-time duty factor

## Switching Characteristics, $T_A = -40^\circ\text{C}$ to $+85^\circ\text{C}$

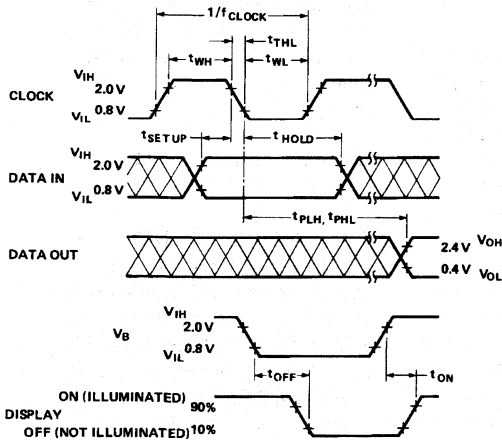

Parameter	Condition	Typ.	Max.	Units
$f_{CLOCK}$ CLOCK Rate			5	MHz
$t_{PLH}$ , $t_{PHL}$ Propagation Delay CLOCK to DATA OUT	$C_L = 15\text{ pF}$ $R_L = 2.4\text{ k}\Omega$		105	ns
$t_{OFF}$ $V_B$ (0.4 V) to Display OFF		4	5	$\mu\text{s}$
$t_{ON}$ $V_B$ (2.4 V) to Display ON		1	2	$\mu\text{s}$

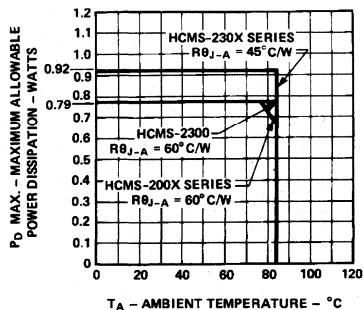

Figure 1. Maximum Allowable Power Dissipation vs Ambient Temperature as a Function of Thermal Resistance Junction-to-Ambient,  $R_{\theta J-A}$ . Derated Operation Assumes  $R_{\theta PC-A} = 35^{\circ}\text{C/W}$  Per Display for the Printed Circuit Board.  $T_j$  (IC) MAX =  $125^{\circ}\text{C}$ .

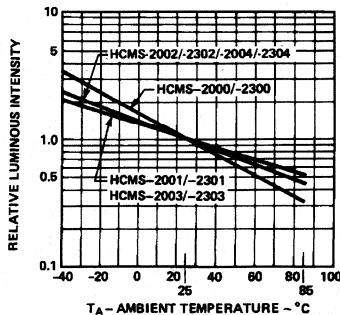

Figure 2. Relative Luminous Intensity vs Display Pin Temperature

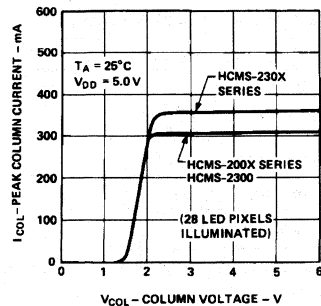

Figure 3. Peak Column Current vs Column Voltage

## Electrical Description

Each display device contains four  $5 \times 7$  LED dot matrix characters and two CMOS integrated circuits, as shown in Figure 4. The two CMOS integrated circuits form an on-board 28 bit serial-in-parallel-out shift register that will accept standard TTL logic levels. The Data Input, pin 12, is connected to bit position 1 and the Data Output, pin 7, is connected to bit position 28. The shift register outputs control constant current sinking LED row drivers. The nominal current sink per LED driver is 11mA for the HCMS-200X displays, 13 mA for the HCMS-230X. A logic 1 stored in the shift register enables the corresponding LED row driver and a logic 0 stored in the shift register disables the corresponding LED row driver.

The electrical configuration of these CMOS IC alphanumeric displays allows for an effective interface to a display controller

circuit that supplies decoded character information. The row data for a given column (one 7 bit byte per character) is loaded (bit serial) into the on-board 28 bit shift register with high to low transitions of the Clock input. To load decoded character information into the display, column data for character 4 is loaded first and the column data for character 1 is loaded last in the following manner. The 7 data bits for column 1, character 4, are loaded into the on-board shift register. Next, the 7 data bits for column 1, character 3, are loaded into the shift register, shifting the character 4 data over one character position. This process is repeated for the other two characters until all 28 bits of column data (four 7 bit bytes of character column data) are loaded into the on-board shift register. Then the column 1 input,  $V_{COL}$  pin 1, is energized to illuminate column 1 in all four characters. This process is repeated for columns 2, 3, 4 and

5. All  $V_{COL}$  inputs should be at logic low to insure the display is off when loading data. The display will be blanked when the blanking input  $V_B$ , pin 8, is at logic low regardless of the outputs of the shift register or whether one of the  $V_{COL}$  inputs is energized.

Refer to Application Note 1016 for drive circuit information.

## ESD Susceptibility

The HCMS-200X/-230X series displays have an ESD susceptibility ratings of CLASS 3 per DOD-STD-1686 and CLASS B per MIL-STD-883C. It is recommended that normal CMOS handling precautions be observed with these devices.

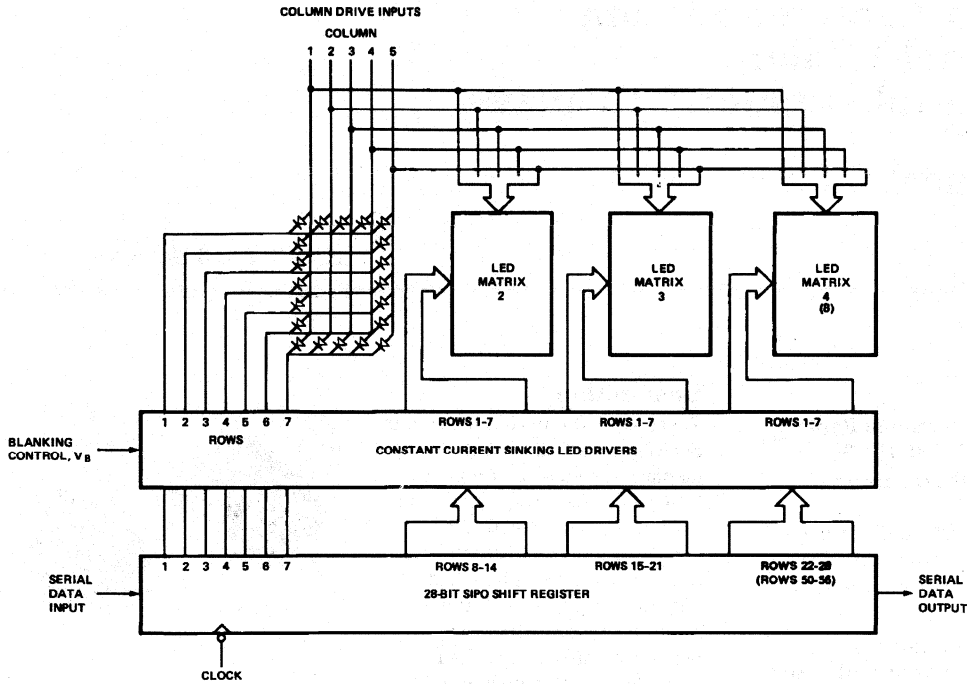

Figure 4. Block Diagram of an HCMS-2XXX Series LED Alphanumeric Display.

### Soldering and Post Solder Cleaning

These displays may be soldered with a standard wave solder process using either an RMA flux and solvent cleaning or an OA flux and aqueous cleaning. For optimum soldering, the solder wave temperature should be 245°C and the dwell time for any display lead passing through the wave should be 1 1/2 to 2 seconds. For more detailed information, refer to Application Note 1027 *Soldering LED Components*.

### Contrast Enhancement

When used with the proper contrast enhancement filters, the HCMS-200X/-230X series displays are readable in bright ambient. Refer to Application Note 1029 *Luminous Contrast and Sunlight Readability of the HDSP-235X Series Alphanumeric Displays for Military Applications* for contrast enhancement in bright ambient. Refer to Application Note 1015 *Contrast Enhancement Techniques for LED Displays* for information on contrast enhancement in moderate ambient.

### Controller Circuits, Power Calculations and Display Dimming

Refer to Application Note 1016 *Using the HDSP-2000 Alphanumeric Display Family* for information on controller circuits to drive these displays, how to do power calculations and a technique for display dimming.

# Four Character 5.0 mm (0.2 inch) Smart 5 x 7 Alphanumeric Displays

## Technical Data

### HDLX-2416 Series

#### Features

- **Enhanced Drop-in Replacement to HPDL-2416**
- **Smart Alphanumeric Display**  
Built-in RAM, ASCII Decoder, and LED Drive Circuitry
- **CMOS IC for Low Power Consumption**
- **Software Controlled Dimming Levels and Blank**
- **128 ASCII Character Set**
- **End-Stackable**
- **Categorized for Luminous Intensity; Yellow and Green Categorized for Color**
- **Low Power and Sunlight Viewable ALGaAs Versions**
- **Wide Operating Temperature Range**  
-40°C to +85°C
- **Excellent ESD Protection**
- **Wave Solderable**
- **Wide Viewing Angle (50° typ)**

#### Description

These are 5.0 mm (0.2 inch) four character 5 x 7 dot matrix displays driven by an on-board CMOS IC. These displays are pin for pin compatible with the HPDL-2416. The IC stores and decodes 7 bit ASCII data and displays it using a 5 x 7 font. Multiplexing circuitry, and drivers are also part of the IC. The IC has fast setup and hold times which makes it easy to interface to a microprocessor.

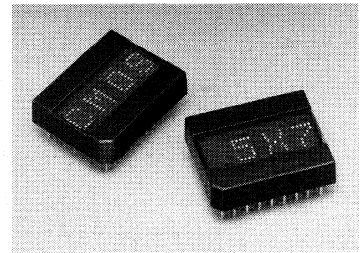

#### Absolute Maximum Ratings

Supply Voltage,  $V_{DD}$  to Ground<sup>[1]</sup> ..... -0.5 V to 7.0 V  
 Input Voltage, Any Pin to Ground ..... -0.5 V to  $V_{DD} + 0.5$  V  
 Free Air Operating Temperature Range,  $T_A$  ..... -40°C to +85°C  
 Storage Temperature,  $T_S$  ..... -40°C to 100°C  
 CMOS IC Junction Temperature,  $T_J$  (IC) ..... +150°C  
 Relative Humidity (non-condensing) at 65°C ..... 85%  
 Maximum Solder Temperature, 1.59 mm  
 (0.063 in.) below Seating Plane,  $t < 5$  sec. .... 260°C  
 ESD Protection,  $R = 1.5$  k $\Omega$ ,  $C = 100$  pF .....  $V_z = 2$  kV (each pin)

**Note:**

1. Maximum Voltage is with no LEDs illuminated.

#### Devices:

Standard Red	ALGaAs Red	High Efficiency Red	Orange	Yellow	Green
HDLR-2416	HDLS-2416	HDLO-2416	HDLA-2416	HDLY-2416	HDLG-2416
	HDLU-2416				

**ESD WARNING: STANDARD CMOS HANDLING PRECAUTIONS SHOULD BE OBSERVED WITH THE HDLX-2416**



The address and data inputs can be directly connected to the microprocessor address and data buses.

The HDLX-2416 has several enhancements over the HPDL-2416. These features include an expanded character set, internal 8 level dimming control, external dimming capability, and individual digit blanking. Finally, the extended functions can be

disabled which allows the HDLX-2416 to operate exactly like an HPDL-2416 by disabling all of the enhancements except the expanded character set.

The difference between the sunlight viewable HDLS-2416 and the low power HDLU-2416 occurs at power-on or at the default brightness level. Following power up, the HDLS-2416 operates at the 100% brightness level, while

the HDLU-2416 operates at the 27% brightness level. Power on sets the internal brightness control (bits 3-5) in the control register to binary code (000). For the HDLS-2416 binary code (000) corresponds to a 100% brightness level, and for the HDLU-2416 binary code (000) corresponds to a 27% brightness level. The other seven brightness levels are identical for both parts.

### Package Dimensions

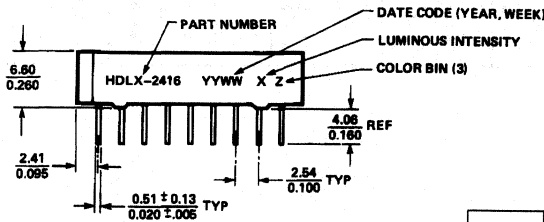
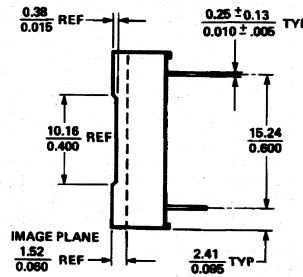
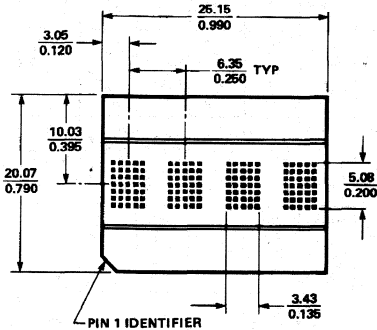

#### Notes:

1. Unless otherwise specified, the tolerance on all dimensions is  $\pm 0.254$  mm ( $\pm 0.010$ " )
2. All dimensions are in mm/inches.
3. For yellow and green displays only.

Pin No.	Function	Pin No.	Function
1	$\overline{CE}_1$ Chip Enable	10	GND
2	$\overline{CE}_2$ Chip Enable	11	D <sub>0</sub> Data Input
3	CLR Clear	12	D <sub>1</sub> Data Input
4	CUE Cursor Enable	13	D <sub>2</sub> Data Input
5	$\overline{CU}$ Cursor Select	14	D <sub>3</sub> Data Input
6	$\overline{WR}$ Write	15	D <sub>6</sub> Data Input
7	A <sub>1</sub> Address Input	16	D <sub>5</sub> Data Input
8	A <sub>0</sub> Address Input	17	D <sub>4</sub> Data Input
9	V <sub>DD</sub>	18	$\overline{BL}$ Display Blank

# Character Set

ASCII CODE				D0	0	1	0	1	0	1	0	1	0	1	0	1	0	1		
				D1	0	0	1	1	0	0	1	1	0	0	1	1	0	0	1	1
				D2	0	0	0	0	1	1	1	1	0	0	0	0	1	1	1	1
				D3	0	0	0	0	0	0	0	0	1	1	1	1	1	1	1	1
D6	D5	D4	Hex	0	1	2	3	4	5	6	7	8	9	A	B	C	D	E	F	
0	0	0	0	!	@	A	B	C	D	E	F	G	H	I	J	K	L	M	N	
0	0	1	1	o	p	q	r	s	t	u	v	w	x	y	z	[	\	]	^	
0	1	0	2			"}	~	?	^	]	[	{	}	~	?	^	]	[	{	
0	1	1	3	0	1	2	3	4	5	6	7	8	9	A	B	C	D	E	F	
1	0	0	4	G	H	I	J	K	L	M	N	O	P	Q	R	S	T	U	V	
1	0	1	5	P	Q	R	S	T	U	V	W	X	Y	Z	[	\	]	^	_	
1	1	0	6	g	h	i	j	k	l	m	n	o	p	q	r	s	t	u	v	
1	1	1	7	p	q	r	s	t	u	v	w	x	y	z	[	\	]	^	_	

NOTES: 1 = HIGH LEVEL  
0 = LOW LEVEL

**Recommended Operating Conditions**

Parameter	Symbol	Min.	Typ.	Max.	Unit
Supply Voltage	$V_{DD}$	4.5	5.0	5.5	V

**Electrical Characteristics over Operating Temperature Range**4.5 <  $V_{DD}$  < 5.5 V (unless otherwise specified)**All Devices**

Parameter	Symbol	Min.	25°C <sup>[1]</sup>		Max.	Units	Test Conditions
			Typ.	Max.			
$I_{DD}$ Blank	$I_{DD}(\text{blank})$		1.0		4.0	mA	All Digits Blanked
Input Current	$I_I$	-40			10	μA	$V_{IN} = 0\text{ V to }V_{DD}$ $V_{DD} = 5.0\text{ V}$
Input Voltage High	$V_{IH}$	2.0			$V_{DD}$	V	
Input Voltage Low	$V_{IL}$	GND			0.8	V	

**HDLO/HDLA/HDLY/HDLG-2416**

Parameter	Symbol	Min.	25°C <sup>[1]</sup>		Max.	Units	Test Conditions
			Typ.	Max.			
$I_{DD}$ 4 digits 20 dots/character <sup>[2,3]</sup>	$I_{DD}(\#)$		110	130	160	mA	"#" ON in all four locations
$I_{DD}$ Cursor all dots ON @ 50%	$I_{DD}(\text{CU})$		92	110	135	mA	Cursor ON in all four locations

**HDLS/HDLU-2416**

Part Number	Parameter	Symbol	25°C <sup>[1]</sup>		Max.	Units	Test Conditions
			Typ.	Max.			
HDLS-2416	$I_{DD}$ 4 digits 20 dots/character <sup>[2,3]</sup>	$I_{DD}(\#)$	125	146	180	mA	Four "#" ON in all four locations
HDLU-2416			34	42			
HDLS-2416	$I_{DD}$ Cursor all dots ON @ 50%	$I_{DD}(\text{CU})$	105	124	154	mA	Four cursors ON in all four locations
HDLU-2416			29	36			

**HDLR-2416**

Parameter	Symbol	Min.	25°C <sup>[1]</sup>		Max.	Units	Test Conditions
			Typ.	Max.			
$I_{DD}$ 4 digits 20 dots/character <sup>[2,3]</sup>	$I_{DD}(\#)$		125	146	180	mA	"#" ON in all four locations
$I_{DD}$ Cursor all dots ON @ 50%	$I_{DD}(\text{CU})$		105	124	154	mA	Cursor ON in all four locations

**Notes:**

- $V_{DD} = 5.0\text{ V}$
- Average  $I_{DD}$  measured at full brightness. Peak  $I_{DD} = 28/15 \times \text{Average } I_{DD}(\#)$ .
- $I_{DD}(\#)$  max. = 130 mA for HDLO/HDLA/HDLY/HDLG-2416, 146 mA for HDLR/HDLS-2416, and 42 mA for HDLU-2416 at default brightness, 150°C IC junction temperature and  $V_{DD} = 5.5\text{ V}$ .

## Optical Characteristics at 25°C<sup>[1]</sup>

V<sub>DD</sub> = 5.0 V at Full Brightness

### HDLR-2416

Parameter	Symbol	Min.	Typ.	Units	Test Conditions
Average Luminous Intensity per digit, Character Average	I <sub>v</sub>	0.5	1.1	mcd	"*" illuminated in all four digits. 19 dots ON
Peak Wavelength	λ <sub>PEAK</sub>		655	nm	
Dominant Wavelength <sup>[2]</sup>	λ <sub>d</sub>		640	nm	

### HDLS/HDLU-2416

Part Number	Parameter	Symbol	Min.	Typ.	Units	Test Conditions
HDLS-2416	Average Luminous Intensity per digit, Character Average	I <sub>v</sub>	4.0	12.7	mcd	"*" illuminated in all four digits, 19 dots ON per digit.
HDLU-2416			1.2	3.1	mcd	
All	Peak Wavelength	λ <sub>PEAK</sub>		645	nm	
	Dominant Wavelength <sup>[2]</sup>	λ <sub>d</sub>		637	nm	

### HDLO-2416

Parameter	Symbol	Min.	Typ.	Units	Test Conditions
Average Luminous Intensity per digit, Character Average	I <sub>v</sub>	1.2	3.5	mcd	"*" illuminated in all four digits. 19 dots ON
Peak Wavelength	λ <sub>PEAK</sub>		635	nm	
Dominant Wavelength <sup>[2]</sup>	λ <sub>d</sub>		626	nm	

### HDLA-2416

Parameter	Symbol	Min.	Typ.	Units	Test Conditions
Average Luminous Intensity per digit, Character Average	I <sub>v</sub>	1.2	3.5	mcd	"*" illuminated in all four digits. 19 dots ON
Peak Wavelength	λ <sub>PEAK</sub>		600	nm	
Dominant Wavelength <sup>[2]</sup>	λ <sub>d</sub>		602	nm	

### HDLY-2416

Parameter	Symbol	Min.	Typ.	Units	Test Conditions
Average Luminous Intensity per digit, Character Average	I <sub>v</sub>	1.2	3.7	mcd	"*" illuminated in all four digits. 19 dots ON
Peak Wavelength	λ <sub>PEAK</sub>		583	nm	
Dominant Wavelength <sup>[2]</sup>	λ <sub>d</sub>		585	nm	

## HDLG-2416

Parameter	Symbol	Min.	Typ.	Units	Test Conditions
Average Luminous Intensity per digit, Character Average	$I_V$	1.2	5.6	mcd	"*" illuminated in all four digits. 19 dots ON
Peak Wavelength	$\lambda_{PEAK}$		568	nm	
Dominant Wavelength <sup>(2)</sup>	$\lambda_d$		574	nm	

### Notes:

- Refers to the initial case temperature of the device immediately prior to the light measurement.
- Dominant wavelength,  $\lambda_d$ , is derived from the CIE chromaticity diagram, and represents the single wavelength which defines the color of the device.

## AC Timing Characteristics over Operating Temperature Range at $V_{DD} = 4.5 V$

Parameter	Symbol	Min	Units
Address Setup	$t_{AS}$	10	ns
Address Hold	$t_{AH}$	40	ns
Data Setup	$t_{DS}$	50	ns
Data Hold	$t_{DH}$	40	ns
Chip Enable Setup	$t_{CES}$	0	ns
Chip Enable Hold	$t_{CEH}$	0	ns
Write Time	$t_W$	75	ns
Clear	$t_{CLR}$	10	$\mu s$
Clear Disable	$t_{CLRD}$	1	$\mu s$

ALPHANUMERIC  
DISPLAYS

## Timing Diagram

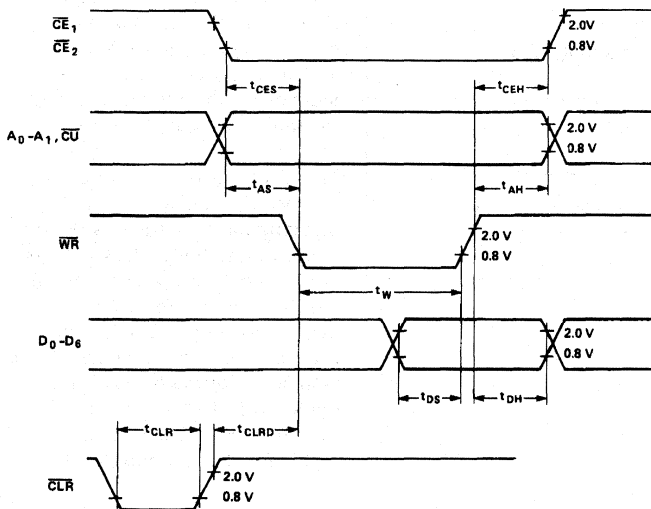

## Enlarged Character Font

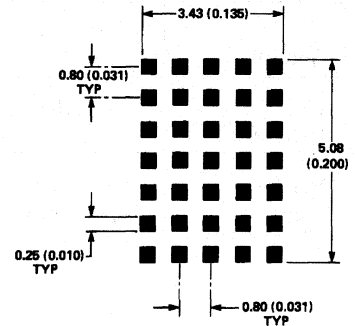

### Notes:

- Unless otherwise specified the tolerance on all dimensions is  $\pm 0.254$  mm (0.010").
- Dimensions are in mm (inches).

## Electrical Description

Pin Function	Description
Chip Enable ( $\overline{CE}_1$ and $\overline{CE}_2$ , pins 1 and 2)	$\overline{CE}_1$ and $\overline{CE}_2$ must be a logic 0 to write to the display.
Clear ( $\overline{CLR}$ , pin 3)	When $\overline{CLR}$ is a logic 0 the ASCII RAM is reset to 20hex (space) and the Control Register/Attribute RAM is reset to 00hex.
Cursor Enable (CUE pin 4)	CUE determines whether the IC displays the ASCII or the Cursor memory. (1 = Cursor, 0 = ASCII).
Cursor Select ( $\overline{CU}$ , pin 5)	$\overline{CU}$ determines whether data is stored in the ASCII RAM or the Attribute RAM/Control Register. (1 = ASCII, 0 = Attribute RAM/Control Register).
Write ( $\overline{WR}$ , pin 6)	$\overline{WR}$ must be a logic 0 to store data in the display.
Address Inputs ( $A_1$ and $A_0$ , pins 8 and 7)	$A_0$ - $A_1$ selects a specific location in the display memory. Address 00 accesses the far right display location. Address 11 accesses the far left location.
Data Inputs ( $D_0$ - $D_6$ , pins 11-17)	$D_0$ - $D_6$ are used to specify the input data for the display.
$V_{DD}$ (pin 9)	$V_{DD}$ is the positive power supply input.
GND (pin 10)	GND is the display ground.
Blanking Input ( $\overline{BL}$ , pin 18)	$\overline{BL}$ is used to flash the display, blank the display or to dim the display.

## Display Internal Block Diagram

Figure 1 shows the HDLX-2416 display internal block diagram. The CMOS IC consists of a 4 x 7 Character RAM, a 2 x 4 Attribute RAM, a 5 bit Control Register, a 128 character ASCII decoder and the refresh circuitry necessary to synchronize the decoding and driving of four 5 x 7 dot matrix displays.

Four 7 bit ASCII words are stored in the Character RAM. The IC reads the ASCII data and decodes it via the 128 character ASCII decoder. The ASCII decoder includes the 64 character set of the HPDL-2416, 32 lower case ASCII symbols, and 32 foreign language symbols.

A 5 bit word is stored in the Control Register. Three fields within the Control Register provide an 8 level brightness control, master blank, and extended functions disable.

For each display digit location, two bits are stored in the Attribute RAM. One bit is used to enable a cursor character at each digit location. A second bit is used to individually disable the blanking features at each digit location.

The display is blanked and dimmed through an internal blanking input on the row drivers. Logic within the IC allows the user to dim the display either through the  $\overline{BL}$  input or through the brightness control in the control register. Similarly the display can be blanked through the  $\overline{BL}$  input, the Master Blank in the Control Register, or the Digit Blank Disable in the Attribute RAM.

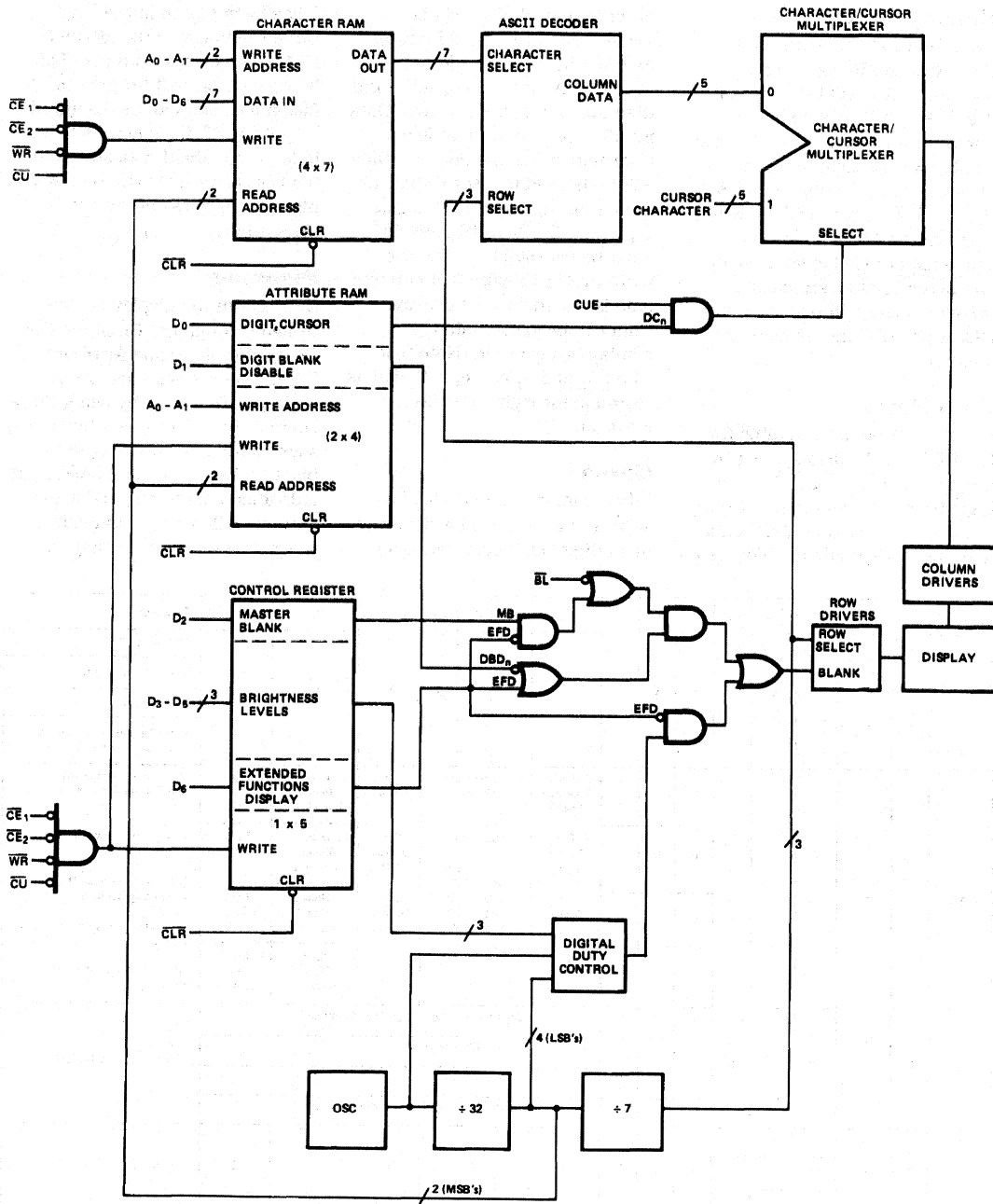

ALPHANUMERIC  
DISPLAYS

Figure 1. Internal Block Diagram

## Display Clear

Data stored in the Character RAM, Control Register, and Attribute RAM will be cleared if the clear ( $\overline{\text{CLR}}$ ) is held low for a minimum of 10  $\mu\text{s}$ . Note that the display will be cleared regardless of the state of the chip enables ( $\overline{\text{CE}}_1, \overline{\text{CE}}_2$ ). After the display is cleared, the ASCII code for a space (20hex) is loaded into all character RAM locations and 00hex is loaded into all Attribute RAM/Control Register memory locations.

## Data Entry

Figure 2 shows a truth table for the HDLX-2416 display. Setting the chip enables ( $\overline{\text{CE}}_1, \overline{\text{CE}}_2$ ) to logic 0 and the cursor select ( $\overline{\text{CU}}$ ) to logic 1 will enable ASCII data loading. When cursor select ( $\overline{\text{CU}}$ )

is set to logic 0, data will be loaded into the Control Register and Attribute RAM. Address inputs  $A_0$ - $A_1$  are used to select the digit location in the display. Data inputs  $D_0$ - $D_6$  are used to load information into the display. Data will be latched into the display on the rising edge of the  $\overline{\text{WR}}$  signal.  $D_0$ - $D_6, A_0$ - $A_1, \overline{\text{CE}}_1, \overline{\text{CE}}_2$ , and  $\overline{\text{CU}}$  must be held stable during the write cycle to ensure that correct data is stored into the display. Data can be loaded into the display in any order. Note that when  $A_0$  and  $A_1$  are logic 0, data is stored in the right most display location.

## Cursor

When cursor enable (CUE) is a logic 1, a cursor will be displayed in all digit locations where a logic

1 has been stored in the Digit Cursor memory in the Attribute RAM. The cursor consists of all 35 dots ON at half brightness. A flashing cursor can be displayed by pulsing CUE. When CUE is a logic 0, the ASCII data stored in the Character RAM will be displayed regardless of the Digit Cursor bits.

## Blanking

Blanking of the display is controlled through the  $\overline{\text{BL}}$  input, the Control Register and Attribute RAM. The user can achieve a variety of functions by using these controls in different combinations, such as full hardware display blank, software blank, blanking of individual characters, and synchronized flashing of individual characters or entire display (by

CUE	$\overline{\text{BL}}$	$\overline{\text{CLR}}$	$\overline{\text{CE}}_1$	$\overline{\text{CE}}_2$	$\overline{\text{WR}}$	$\overline{\text{CU}}$	$A_1$	$A_0$	$D_6$	$D_5$	$D_4$	$D_3$	$D_2$	$D_1$	$D_0$	Function
0	1	1														Display ASCII
1	1	1														Display Stored Cursor
X	X	0	X	X	X	X	X	X	X	X	X	X	X	X	X	Reset RAMs
X	0	1														Blank Display but do not reset RAMs and Control Register
X	X	1	0	0	0	0	0	0	0	Extended Functions Disable 000 = 100%* 001 = 60% 010 = 40% 011 = 27% 100 = 17% 101 = 10% 110 = 7% 111 = 3%	Intensity Control	Master Blank 0 = Display ON 1 = Display Blanked	Digit Blank Disable 0	Digit Cursor 0	Write to Attribute RAM and Control Register	
							0	0	1							0 = $\text{DBD}_n = 0$ , Allows Digit n to be blanked
							0	1	0							1 = $\text{DBD}_n = 1$ Prevents Digit n from being blanked.
							0	1	1							$\text{DC}_n = 0$ Removes cursor from Digit n $\text{DC}_n = 1$ Stores cursor at Digit n
X	X	1	0	0	0	0	1	0	0	Digit 0 ASCII Data (Right Most Character)	Digit 1 ASCII Data	Digit 2 ASCII Data	Digit 3 ASCII Data (Left Most Character)	Write to Character RAM		
							1	0	1							
							1	1	0							
							1	1	1							
X	X	1	1	X	X	X	X	X	X	X	X	X	X	X	X	No Change
			X	1	X											
			X	X	1											

0 = Logic 0; 1 = Logic 1; X = Do Not Care; \* 000 = 27% for HDLU-2416

Figure 2. Display Truth Table



strobing the blank input). All of these blanking modes affect only the output drivers, maintaining the contents and write capability of the internal RAMs and Control Register, so that normal loading of RAMs and Control Register can take place even with the display blanked.

Figure 3 shows how the Extended Function Disable (bit  $D_6$  of the Control Register), Master Blank (bit  $D_2$  of the Control Register), Digit Blank Disable (bit  $D_1$  of the Attribute RAM), and  $\overline{BL}$  input can be used to blank the display.

When the Extended Function Disable is a logic 1, the display can be blanked only with the  $\overline{BL}$  input. When the Extended Function Disable is a logic 0, the display can be blanked through the  $\overline{BL}$  input, the Master Blank, and the Digit Blank Disable. The entire display will be blanked if either the  $\overline{BL}$  input is logic 0 or the Master Blank is logic 1, providing all Digit Blank Disable bits are logic 0. Those digits with Digit Blank Disable bits a logic 1 will ignore both blank signals and remain ON. The Digit Blank Disable bits allow individual characters to be blanked or flashed in synchronization with the  $\overline{BL}$  input.

EFD	MB	DBD <sub>n</sub>	$\overline{BL}$	
0	0	0	0	Display Blanked by BL
0	0	X	1	Display ON
0	X	1	0	Display Blanked by BL. Individual characters "ON" based on "1" being stored in DBD <sub>n</sub>
0	1	0	X	Display Blanked by MB
0	1	1	1	Display Blanked by MB. Individual characters "ON" based on "1" being stored in DBD <sub>n</sub>
1	X	X	0	Display Blanked by BL
1	X	X	1	Display ON

Figure 3. Display Blanking Truth Table

### Dimming

Dimming of the display is controlled through either the  $\overline{BL}$  input or the Control Register. A pulse width modulated signal can be applied to the  $\overline{BL}$  input to dim the display. A three bit word in the Control Register generates an internal pulse width modulated signal to dim the display. The internal dimming feature is enabled only if the Extended Function Disable is a logic 0.

Bits 3-5 in the Control Register provide internal brightness control. These bits are interpreted as a three bit binary code, with code (000) corresponding to the maximum brightness and code (111) to the minimum brightness. In addition to varying the display brightness, bits 3-5 also vary the average value of  $I_{DD}$ .  $I_{DD}$  can be specified at any brightness level as shown in Table 1.

Table 1. Current Requirements at Different Brightness Levels

Symbol	$D_5$	$D_4$	$D_3$	Brightness	25°C Typ.	25°C Max.	Max. over Temp.	Units
$I_{DD}(\#)$	0	0	0	100%	110	130	160	mA
	0	0	1	60%	66	79	98	mA
	0	1	0	40%	45	53	66	mA
	0	1	1	27%	30	37	46	mA
	1	0	0	17%	20	24	31	mA
	1	0	1	10%	12	15	20	mA
	1	1	0	7%	9	11	15	mA
	1	1	1	3%	4	6	9	mA

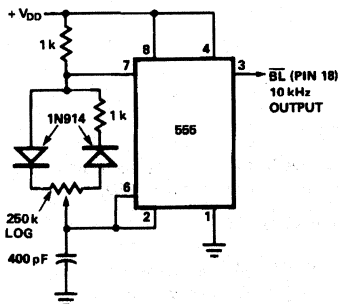

**Figure 4. Intensity Modulation Control Using an Astable Multivibrator** (reprinted with permission from *Electronics* magazine, Sept. 19, 1974, VNU Business pub. Inc.)

Figure 4 shows a circuit designed to dim the display from 98% to 2% by pulse width modulating the  $\overline{BL}$  input. A logarithmic or a linear potentiometer may be used to adjust the display intensity. However, a logarithmic potentiometer matches the response of the human eye and therefore provides better resolution at low intensities. The circuit frequency should be designed to operate at 10 kHz or higher. Lower frequencies may cause the display to flicker.

### Extended Function Disable

Extended Function Disable (bit  $D_6$  of the Control Register) disables the extended blanking and dimming functions in the HDLX-2416. If the Extended Function Disable is a logic 1, the internal brightness control, Master Blank, and Digit Blank Disable bits are ignored. However the  $\overline{BL}$  input and Cursor control are still active. This allows downward compatibility to the HPDL-2416.

### Mechanical and Electrical Considerations

The HDLX-2416 is an 18 pin DIP package that can be stacked horizontally and vertically to create arrays of any size. The HDLX-2416 is designed to operate continuously from  $-40^\circ\text{C}$  to  $+85^\circ\text{C}$  for all possible input conditions.

The HDLX-2416 is assembled by die attaching and wire bonding 140 LEDs and a CMOS IC to a high temperature printed circuit board. A polycarbonate lens is placed over the PC board creating an air gap environment for the LED wire bonds. Backfill epoxy environmentally seals the display package. This package construction makes the display highly tolerant to temperature cycling and allows wave soldering.

The inputs to the CMOS IC are protected against static discharge and input current latchup. However, for best results standard CMOS handling precautions should be used. Prior to use, the HDLX-2416 should be stored in anti-static tubes or conductive material. During assembly a grounded conductive work area should be used, and assembly personnel should wear conductive wrist straps. Lab coats made of synthetic material should be avoided since they are prone to static charge build-up.

Input current latchup is caused when the CMOS inputs are subjected either to a voltage below ground ( $V_{in} < \text{ground}$ ) or to a voltage higher than  $V_{DD}$  ( $V_{in} > V_{DD}$ ) and when a high current is forced into the input. To prevent input current latchup and ESD damage, unused inputs should be

connected either to ground or to  $V_{DD}$ . Voltages should not be applied to the inputs until  $V_{DD}$  has been applied to the display. Transient input voltages should be eliminated.

### Soldering and Post Solder Cleaning Instructions for the HDLX-2416

The HDLX-2416 may be hand soldered or wave soldered with SN63 solder. When hand soldering it is recommended that an electronically temperature controlled and securely grounded soldering iron be used. For best results, the iron tip temperature should be set at  $315^\circ\text{C}$  ( $600^\circ\text{F}$ ). For wave soldering, a rosin-based RMA flux can be used. The solder wave temperature should be set at  $245^\circ\text{C} \pm 5^\circ\text{C}$  ( $473^\circ\text{F} \pm 9^\circ\text{F}$ ), and dwell in the wave should be set between 1 1/2 to 3 seconds for optimum soldering. The preheat temperature should not exceed  $110^\circ\text{C}$  ( $230^\circ\text{F}$ ) as measured on the solder side of the PC board.

For further information on soldering and post solder cleaning, see Application Note 1027, *Soldering LED Components*.

### Contrast Enhancement

The objective of contrast enhancement is to provide good readability in the end user's ambient lighting conditions. The concept is to employ both luminance and chrominance contrast techniques. These enhance readability by having the OFF-dots blend into the display background and the ON-dots vividly stand out against the same background. For additional information on contrast enhancement, see Application Note 1015.

---

# Four Character Smart Alphanumeric Displays

## Technical Data

**HPDL-1414  
HPDL-2416**

---

### Features

- **Smart Alphanumeric Display**  
Built-in RAM, ASCII Decoder and LED Drive Circuitry
- **Wide Operating Temperature Range**  
-40°C to +85°C
- **Fast Access Time**  
160 ns
- **Excellent ESD Protection**  
Built-in Input Protection Diodes
- **CMOS IC for Low Power Consumption**
- **Full TTL Compatibility Over Operating Temperature Range**  
 $V_{IL} = 0.8 V$   
 $V_{IH} = 2.0 V$
- **Wave Solderable**
- **Rugged Package Construction**
- **End-Stackable**
- **Wide Viewing Angle**

### Typical Applications

- **Portable Data Entry Devices**
- **Medical Equipment**

- **Process Control Equipment**
- **Test Equipment**
- **Industrial Instrumentation**
- **Computer Peripherals**
- **Telecommunication Instrumentation**

### Description

The HPDL-1414 and 2416 are smart, four character, sixteen-segment, red GaAsP displays. The HPDL-1414 has a character height of 2.85 mm (0.112"). The HPDL-2416 has a character height of 4.10 mm (0.160"). The on-board CMOS IC contains memory, ASCII decoder, multiplexing circuitry and drivers. The monolithic LED characters are magnified by an immersion lens which increases both character size and luminous intensity. The encapsulated dual-in-line package provides a rugged, environmentally sealed unit.

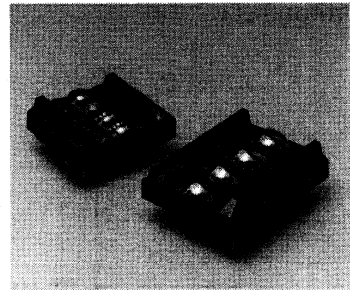

The HPDL-1414 and 2416 incorporate many improvements over competitive products. They have a wide operating temperature range, very fast IC access time, and improved ESD protection. The displays are also fully TTL compatible, wave solderable, and highly reliable. These displays are ideally suited for industrial and commercial applications where a good-looking, easy-to-use alphanumeric display is required.

ALPHANUMERIC  
DISPLAYS

**ESD WARNING: STANDARD CMOS HANDLING PRECAUTIONS SHOULD BE OBSERVED WITH THE HPDL-1414 AND HPDL-2416.**

## Absolute Maximum Ratings

Supply Voltage, $V_{DD}$ to Ground.....	-0.5 V to 7.0 V
Input Voltage, Any Pin to Ground.....	-0.5 V to $V_{DD} + 0.5$ V
Free Air Operating Temperature Range, $T_A$ <sup>[1]</sup> .....	-40°C to +85°C
Relative Humidity (non-condensing) at 65°C.....	90%
Storage Temperature, $T_S$ .....	-40°C to +85°C
Maximum Solder Temperature, 1.59 mm (0.063 in.) below Seating Plane, $t < 5$ sec. ....	260°C
ESD Protection @ 1.5 k $\Omega$ , 100 pF.....	$V_Z = 2$ kV (each Pin)

\*All typicals at  $T_A = 25^\circ\text{C}$ .

## Package Dimensions

### HPDL-1414

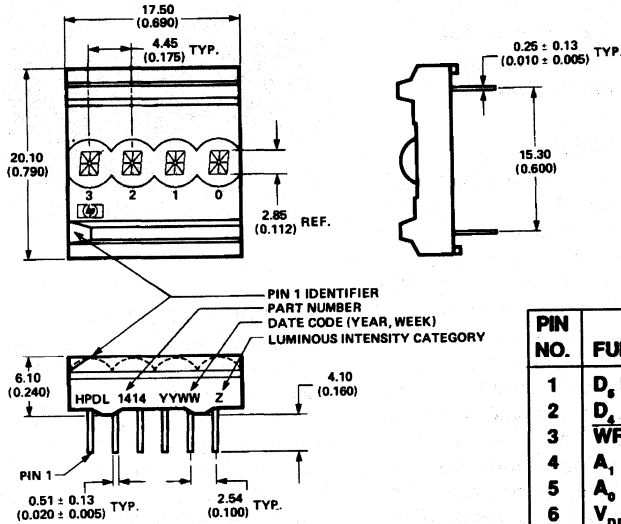

PIN NO.	FUNCTION	PIN NO.	FUNCTION
1	$D_5$ DATA INPUT	7	GND
2	$D_4$ DATA INPUT	8	$D_0$ DATA INPUT
3	$WR$ WRITE	9	$D_1$ DATA INPUT
4	$A_1$ DIGIT SELECT	10	$D_2$ DATA INPUT
5	$A_0$ DIGIT SELECT	11	$D_3$ DATA INPUT
6	$V_{DD}$	12	$D_4$ DATA INPUT

#### NOTES:

- UNLESS OTHERWISE SPECIFIED, THE TOLERANCE ON ALL DIMENSIONS IS 0.254 mm (0.010 in.).
- DIMENSIONS IN mm (Inches).

# HPDL-2416

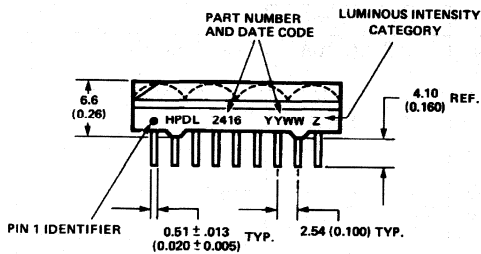
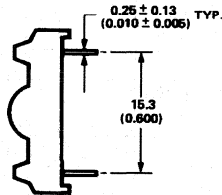
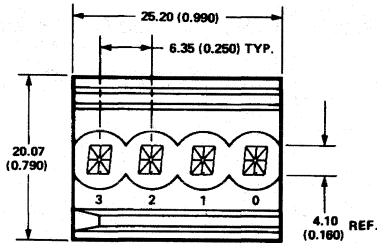

PIN NO.	FUNCTION	PIN NO.	FUNCTION
1	$\overline{CE}$ CHIP ENABLE	10	GND
2	$\overline{CE}$ CHIP ENABLE	11	D <sub>0</sub> DATA INPUT
3	CLR CLEAR	12	D <sub>1</sub> DATA INPUT
4	CUE CURSOR ENABLE	13	D <sub>2</sub> DATA INPUT
5	$\overline{CU}$ CURSOR SELECT	14	D <sub>3</sub> DATA INPUT
6	WR WRITE	15	D <sub>4</sub> DATA INPUT
7	ADDRESS INPUT A <sub>1</sub>	16	D <sub>5</sub> DATA INPUT
8	ADDRESS INPUT A <sub>0</sub>	17	D <sub>6</sub> DATA INPUT
9	V <sub>DD</sub>	18	BL DISPLAY BLANK

- NOTES:  
 1. UNLESS OTHERWISE SPECIFIED, THE TOLERANCE ON ALL DIMENSIONS IS 0.254 mm (0.010 in.).  
 2. DIMENSIONS IN mm (inches).

## Recommended Operating Conditions

Parameter	Sym.	Min.	Nom.	Max.	Units
Supply Voltage	V <sub>DD</sub>	4.5	5.0	5.5	V

ALPHANUMERIC DISPLAYS

### DC Electrical Characteristics over Operating Temperature Range

Parameter	Sym.	Min.	25°C Typ.	25°C Max.	Max. <sup>[1]</sup>	Units	Test Conditions
Input Current HPDL-1414	I <sub>IL</sub>		17	30	50	μA	V <sub>DD</sub> = 5.0 V, $\overline{BL}$ = 0.8 V
HPDL-2416			17	30	40	μA	
I <sub>DD</sub> Blank HPDL-1414	I <sub>DD</sub> ( $\overline{BL}$ )		1.2	2.3	4.0	mA	V <sub>DD</sub> = 5.0 V, $\overline{BL}$ = 0.8 V
HPDL-2416			1.5	3.5	8.0	mA	
I <sub>DD</sub> 4 Digits ON (10 Segments/digit) <sup>[2,3]</sup> HPDL-1414	I <sub>DD</sub>		70	90	130	mA	V <sub>DD</sub> = 5.0 V
HPDL-2416			85	115	170	mA	
I <sub>DD</sub> 4 Digits ON Cursor <sup>[4]</sup> HPDL-2416	I <sub>DD</sub> (CU)		125	165	232	mA	V <sub>DD</sub> = 5.0 V
Input Voltage High	V <sub>IH</sub>	2.0			V <sub>DD</sub>	V	
Input Voltage Low	V <sub>IL</sub>	GND			0.8	V	
Power Dissipation <sup>[5]</sup> HPDL-1414	P <sub>D</sub>		350	450	715	mW	V <sub>DD</sub> = 5.0 V
HPDL-2416			425	575	910	mW	

**Notes:**

- V<sub>DD</sub> = 5.5 V.
- "%" illuminated in all four characters.
- Measured at five seconds.
- Cursor character is sixteen segments and DP ON.
- Power Dissipation = (V<sub>DD</sub>)(I<sub>DD</sub>) for 10 segments ON.

### Optical Characteristics at 25°C<sup>[6]</sup>

Parameter	Sym.	Min.	Typ.	Units	Test Conditions	
Peak Luminous Intensity per Digit, 8 segments ON (character average) HPDL-1414	I <sub>V</sub> Peak		0.4	1.0	mcd	V <sub>DD</sub> = 5.0 V, "%" illuminated in all 4 digits
HPDL-2416			0.5	1.25	mcd	
Peak Wavelength	λ <sub>Peak</sub>		655	nm		
Dominant Wavelength	λ <sub>d</sub>		640	nm		
Off Axis Viewing Angle HPDL-1414			± 40	degrees		
HPDL-2416			± 50	degrees		

**AC Timing Characteristics over Operating Temperature Range at  $V_{CC} = 4.5\text{ V}$**

Parameter	Symbol	-20°C $t_{MIN}$	25°C $t_{MIN}$	70°C $t_{MIN}$	Units
Address Setup Time	$t_{AS}$	90	115	150	ns
Write Delay Time	$t_{WD}$	10	15	20	ns
Write Time	$t_W$	80	100	130	ns
Data Setup Time	$t_{DS}$	40	60	80	ns
Data Hold Time	$t_{DH}$	40	45	50	ns
Address Hold Time	$t_{AH}$	40	45	50	ns
Chip Enable Hold Time <sup>[1]</sup>	$t_{CEH}$	40	45	50	ns
Chip Enable Setup Time <sup>[1]</sup>	$t_{CES}$	90	115	150	ns
Clear Time <sup>[1]</sup>	$t_{CLR}$	2.4	3.5	4.0	ms
Access Time		130	160	200	ns
Refresh Rate		420-790	310-630	270-550	Hz

**Note:**

1. HPDL-2416 only.

**Timing Diagram**

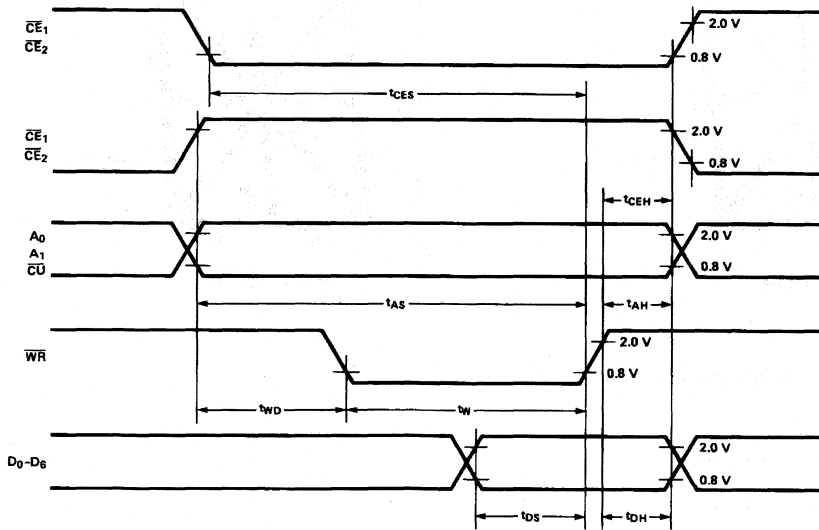

### Character Set

BITS		D <sub>3</sub>	D <sub>2</sub>	D <sub>1</sub>	D <sub>0</sub>	0	1	2	3	4	5	6	7	8	9	A	B	C	D	E	F
D <sub>6</sub>	D <sub>5</sub> D <sub>4</sub>	0	0	0	0	0	0	0	0	0	0	0	0	0	0	0	0	0	0	0	0
0	1	0	0	0	0	0	1	1	1	1	1	1	1	1	0	0	0	0	1	1	1
0	1	0	0	1	0	0	0	0	0	0	0	1	0	0	0	1	0	0	0	0	0
0	1	1	3	(space)	!	"	#	\$	%	&	'	<	>	*	+	,	-	.	/		
1	0	0	4	0	1	2	3	4	5	6	7	8	9	-	=	>	?				
1	0	1	5	P	Q	R	S	T	U	V	W	X	Y	Z	[	\	]	^	_		

### Magnified Character Font Description

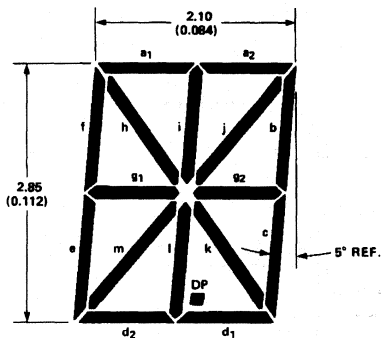

HPDL-1414

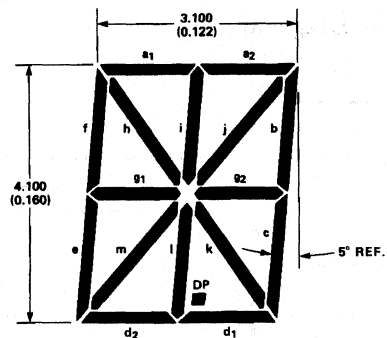

HPDL-2416

### Relative Luminous Intensity vs. Temperature

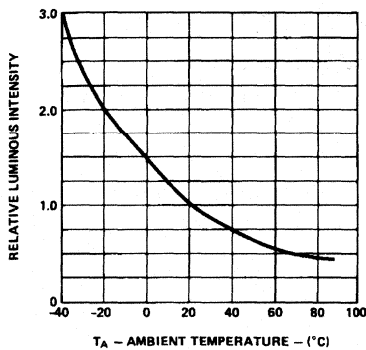



## Electrical Description

### Display Internal Block Diagram HPDL-1414

Figure 1 shows the internal block diagram of the HPDL-1414. It consists of two parts: the display LEDs and the CMOS IC. The CMOS IC consists of a four-word ASCII memory, a 64-word character generator, 17 segment drivers, four digit drivers, and the scanning circuitry necessary to multiplex the four monolithic LED characters. In normal

operation, the divide-by-four counter sequentially accesses each of the four RAM locations and simultaneously enables the appropriate display digit driver. The output of the RAM is decoded by the character generator which, in turn, enables the appropriate display segment drivers. Seven-bit ASCII data is stored in RAM. Since the display uses a 64-character decoder, half of the possible 128 input combinations are invalid. For each display location where  $D_5 = D_6$  in the

ASCII RAM, the display character is blanked.

### Data Entry HPDL-1414

Figure 2 shows a truth table for the HPDL-1414. Data is loaded into the display through the DATA inputs ( $D_6-D_0$ ), ADDRESS inputs ( $A_1-A_0$ ), and WRITE ( $\overline{WR}$ ). After a character has been written to memory, the IC decodes the ASCII data, drives the display and refreshes it without any external hardware or software.

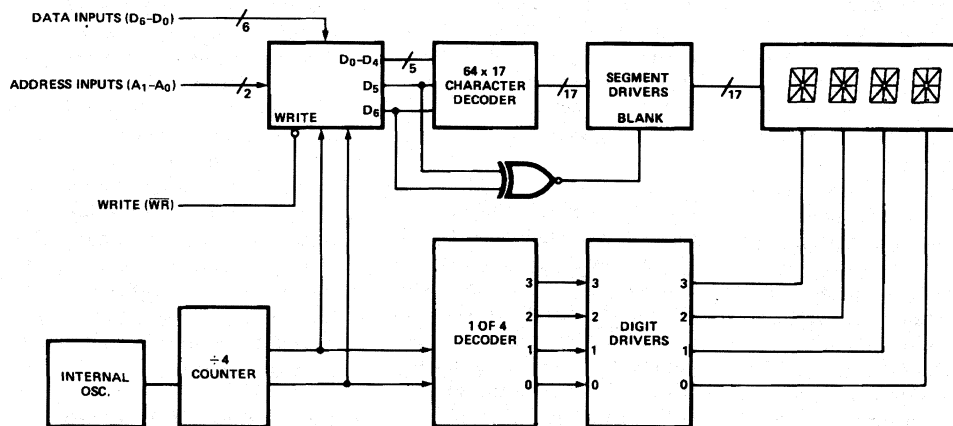

Figure 1. HPDL-1414 Internal Block Diagram.

$\overline{WR}$	$A_1$	$A_0$	$D_6$	$D_5$	$D_4$	$D_3$	$D_2$	$D_1$	$D_0$	$DIG_3$	$DIG_2$	$DIG_1$	$DIG_0$
L	L	L	a	a	a	a	a	a	a	NC	NC	NC	F
L	L	H	b	b	b	b	b	b	b	NC	NC	B	NC
L	H	L	c	c	c	c	c	c	c	NC	C	NC	NC
L	H	H	d	d	d	d	d	d	d	I	NC	NC	NC
H	X	X	X	X	X	X	X	X	X	Previously Written Data			

L = LOGIC LOW INPUT  
H = LOGIC HIGH INPUT  
X = DON'T CARE  
"a" = ASCII CODE CORRESPONDING TO SYMBOL "A"  
NC = NO CHANGE

Figure 2. HPDL-1414 Write Truth Table.

### Display Internal Block Diagram HPDL-2416

Figure 3 shows the internal block diagram for the HPDL-2416 display. The CMOS IC consists of a four-word ASCII memory, a four-word cursor memory, a 64-word character generator, 17 segment drivers, four digit drivers, and the scanning circuitry necessary to multiplex the four monolithic LED characters. In normal operation, the divide-by-four counter sequentially accesses each of the four RAM locations and simultaneously enables the appropriate display digit driver. The output of the RAM is decoded by the character generator which, in turn, enables the appropriate display segment drivers. For each display location, the cursor enable (CUE) selects whether the data from the ASCII RAM (CUE = 0) or the stored cursor (CUE = 1) is to be displayed. The cursor character is denoted by all sixteen segments and the DP ON. Seven-bit ASCII data is stored in RAM. Since the display utilizes a 64-character

decoder, half of the possible 128 input combinations are invalid. For each display location where  $D_5 = D_6$  in the ASCII RAM, the display character is blanked. The entire display is blanked when  $BL = 0$ .

Data is loaded into the display through the data inputs ( $D_6 - D_0$ ), address inputs ( $A_1, A_0$ ), chip enables ( $\overline{CE}_1, \overline{CE}_2$ ), cursor select ( $\overline{CU}$ ), and write ( $\overline{WR}$ ). The cursor select ( $\overline{CU}$ ) determines whether data is stored in the ASCII RAM ( $\overline{CU} = 1$ ) or cursor memory ( $\overline{CU} = 0$ ). When  $\overline{CE}_1 = \overline{CE}_2 = \overline{WR} = 0$  and  $\overline{CU} = 1$ , the information on the data inputs is stored in the ASCII RAM at the location specified by the address inputs ( $A_1, A_0$ ). When  $\overline{CE}_1 = \overline{CE}_2 = \overline{WR} = 0$  and  $\overline{CU} = 0$ , information on the data input,  $D_0$ , is stored in the cursor at the location specified by the address inputs ( $A_1, A_0$ ). If  $D_0 = 1$ , a cursor character is stored in the cursor memory. If  $D_0 = 0$ , a previously stored cursor character will be removed from the cursor memory.

If the clear input ( $\overline{CLR}$ ) equals zero for one internal display cycle (4 ms minimum), the data in the ASCII RAM will be rewritten with zeroes and the display will be blanked. Note that the blanking input ( $\overline{BL}$ ) must be equal to logical one during this time.

### Data Entry HPDL-2416

Figure 4 shows a truth table for the HPDL-2416 display. Setting the chip enables ( $\overline{CE}_1, \overline{CE}_2$ ) to their low state and the cursor select ( $\overline{CU}$ ) to its high state will enable data loading. The desired data inputs ( $D_6 - D_0$ ) and address inputs ( $A_1, A_0$ ) as well as the chip enables ( $\overline{CE}_1, \overline{CE}_2$ ) and cursor select ( $\overline{CU}$ ) must be held stable during the write cycle to ensure that the correct data is stored into the display. Valid ASCII data codes are shown in Figure 1. The display accepts standard seven-bit ASCII data. Note that  $D_6 \neq D_5$  for the codes shown in Figure 4. If  $D_6 = D_5$  during the write cycle, then a blank will be stored in the display. Data can be loaded into the display in any order. Note that when  $A_1 = A_0 = 0$ , data is stored in the furthest right-hand display location.

### Cursor Entry HPDL-2416

As shown in Figure 4, setting the chip enables ( $\overline{CE}_1, \overline{CE}_2$ ) to their low state and the cursor select ( $\overline{CU}$ ) to its low state will enable cursor loading. The cursor character is indicated by the display symbol having all 16 segments and the DP ON. The least significant data input ( $D_0$ ), the address inputs ( $A_1, A_0$ ), the chip enables ( $\overline{CE}_1, \overline{CE}_2$ ), and the cursor select ( $\overline{CU}$ ) must be held stable during the write cycle to

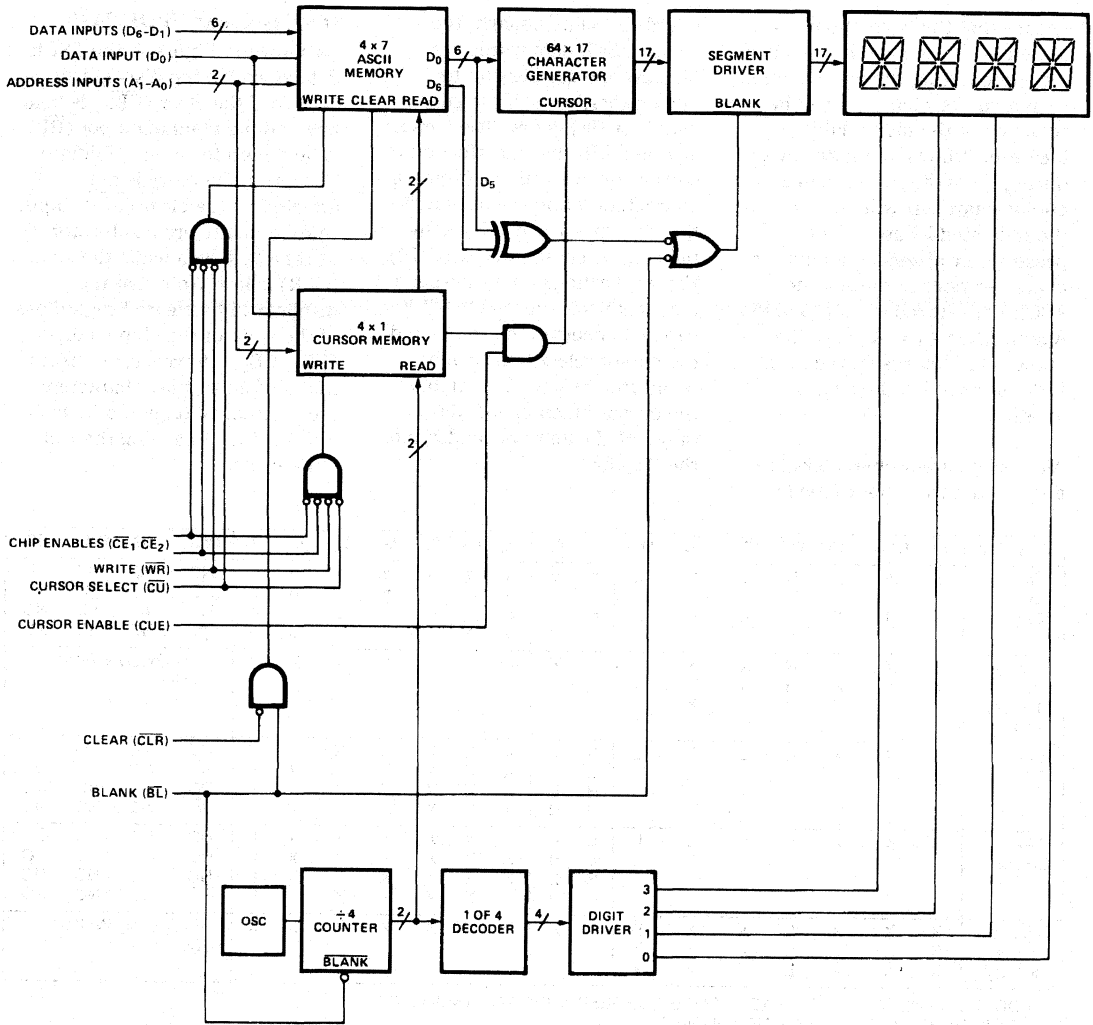

ALPHANUMERIC  
DISPLAYS

Figure 3. HPDL-2416 Internal Block Diagram.

ensure that the correct data is stored in the display. If  $D_0$  is in a low state during the write cycle, then a cursor character will be removed at the indicated location. If  $D_0$  is in a high state during the write cycle, then a cursor character will be stored at the indicated location. The presence or absence of a cursor character does not affect the ASCII data stored at that location. Again, when  $A_1 = A_0 = 0$ , the cursor character is stored in the furthest right-hand display location.

All stored cursor characters are displayed if the cursor enable

(CUE) is high. Similarly, the stored ASCII data words are displayed, regardless of the cursor characters, if the cursor enable (CUE) is low. The cursor enable (CUE) has no effect on the storage or removal of the cursor characters within the display. A flashing cursor is displayed by pulsing the cursor enable (CUE). For applications not requiring a cursor, the cursor enable (CUE) can be connected to ground and the cursor select ( $\overline{CU}$ ) can be connected to  $V_{CC}$ . This inhibits the cursor function and allows only ASCII data to be loaded into the display.

### Display Clear HPDL-2416

As shown in Figure 4, the ASCII data stored in the display will be cleared if the clear ( $\overline{CLR}$ ) is held low and the blanking input ( $\overline{BL}$ ) is held high for 4 ms minimum. The cursor memory is not affected by the clear ( $\overline{CLR}$ ) input. Cursor characters can be stored or removed even while the clear ( $\overline{CLR}$ ) is low. Note that the display will be cleared regardless of the state of the chip enables ( $\overline{CE}_1, \overline{CE}_2$ ). However, to ensure that all four display characters are cleared,  $\overline{CLR}$  should be held low for 4 ms following the last write cycle.

Function	$\overline{BL}$	$\overline{CLR}$	CUE	$\overline{CU}$	$\overline{CE}_1$	$\overline{CE}_2$	WR	$A_1$	$A_0$	$D_6$	$D_5$	$D_4$	$D_3$	$D_2$	$D_1$	$D_0$	DIG <sub>3</sub>	DIG <sub>2</sub>	DIG <sub>1</sub>	DIG <sub>0</sub>
Write Data Memory	L	X	X	H	L	L	L	L	L	a	a	a	a	a	a	a	NC	NC	NC	F
	X	H	X	H	L	L	L	L	L	b	b	b	b	b	b	b	NC	NC	B	NC
Disable Data Memory Write	X	X	X	H	X	X	H	X	X	X	X	X	X	X	X	X	NC	NC	C	NC
	X	X	X	H	H	X	X	X	X	c	c	c	c	c	c	c	NC	NC	I	NC
Write Cursor	X	X	X	L	L	L	L	L	L	X	X	X	X	X	X	H	NC	NC	NC	⊗
	X	X	X	L	L	L	L	L	L	X	X	X	X	X	X	H	NC	NC	⊗	NC
Clear Cursor	X	X	X	L	L	L	L	L	L	X	X	X	X	X	X	L	NC	NC	NC	□
	X	X	X	L	L	L	L	L	L	X	X	X	X	X	X	L	NC	NC	□	NC
Disable Cursor Memory	X	X	X	L	X	X	H	X	X	X	X	X	X	X	X	X	NC	NC	NC	NC
	X	X	X	L	H	X	X	X	X	X	X	X	X	X	X	X	NC	NC	NC	NC

L = LOGIC LOW INPUT  
H = LOGIC HIGH INPUT  
X = DON'T CARE  
"a" = ASCII CODE CORRESPONDING TO SYMBOL "A"  
NC = NO CHANGE  
⊗ = CURSOR CHARACTER (ALL SEGMENTS ON)

Figure 4a. Cursor/Data Memory Write Truth Table.

Function	$\overline{BL}$	$\overline{CLR}$	CUE	$\overline{CU}$	$\overline{CE}_1$	$\overline{CE}_2$	WR	DIG <sub>3</sub>	DIG <sub>2</sub>	DIG <sub>1</sub>	DIG <sub>0</sub>
CUE	H	H	L	X	X	X	X	F	B	C	I
	H	H	H	X	X	X	X	⊗	⊗	⊗	⊗
Clear	H	L	X	X	X	X	X*	□	□	□	□
	*NOTE: CLR should be held low for 4 ms following the last WRITE cycle to ensure all data is cleared.										
Blanking	L	X	X	X	X	X	X	□	□	□	□

Figure 4b. Displayed Data Truth Table.

### Display Blank HPDL-2416

As shown in Figure 4, the display will be blanked if the blanking input ( $\overline{BL}$ ) is held low. Note that the display will be blanked regardless of the state of the chip enables ( $\overline{CE}_1$ ,  $\overline{CE}_2$ ) or write ( $\overline{WR}$ ) inputs. The ASCII data stored in the display and the cursor memory are not affected by the blanking input. ASCII data and cursor data can be stored even while the blanking input ( $\overline{BL}$ ) is low. Note that while the blanking input ( $\overline{BL}$ ) is low, the clear ( $\overline{CLR}$ ) function is inhibited. A flashing display can be obtained by applying a low frequency square wave to the blanking input ( $\overline{BL}$ ). Because the blanking input ( $\overline{BL}$ ) also resets the internal display multiplex counter, the frequency applied to the blanking input ( $\overline{BL}$ ) should be much slower than the display multiplex rate. Finally, dimming of the display through the blanking input ( $\overline{BL}$ ) is not recommended.

For further application information please consult Application Note 1026.

### Optical Considerations/ Contrast Enhancement

The HPDL-1414 and HPDL-2416 displays use a precision aspheric immersion lens to provide excellent readability and low off-axis distortion. For the HPDL-1414, the aspheric lens produces a magnified character height of 2.85 mm (0.112 in.) and a viewing angle of  $\pm 40^\circ$ . For the HPDL-2416, the aspheric lens produces a magnified character height of 4.1 mm (0.160 in.) and a viewing angle of  $\pm 50^\circ$ . These features provide excellent readability at distances up to 1.5 metres (4 feet) for the HPDL-

1414 and 2 metres (6 feet) for the HPDL-2416.

Each HPDL-1414/2416 display is tested for luminous intensity and marked with an intensity category on the side of the display package. To ensure intensity matching for multiple package applications, mixing intensity categories for a given panel is not recommended.

The HPDL-1414/2416 display is designed to provide maximum contrast when placed behind an appropriate contrast enhancement filter. For further information on contrast enhancement, see Hewlett-Packard Application Note 1015.

### Mechanical and Electrical Considerations

The HPDL-1414/2416 are dual in-line packages that can be stacked horizontally and vertically to create arrays of any size. These displays are designed to operate continuously between  $-40^\circ\text{C}$  to  $+85^\circ\text{C}$  with a maximum of 10 segments on per digit.

During continuous operation of all four Cursors the operating temperature should be limited to  $-40^\circ\text{C}$  to  $+55^\circ\text{C}$ . At temperatures above  $+55^\circ\text{C}$ , the maximum number of Cursors illuminated continuously should be reduced as follows: No Cursors illuminated at operating temperatures above  $75^\circ\text{C}$ . One Cursor can be illuminated continuously at operating temperatures below  $75^\circ\text{C}$ . Two Cursors can be illuminated continuously at operating temperatures below  $68^\circ\text{C}$ . Three Cursors can be illuminated continuously at operating temperatures below  $60^\circ\text{C}$ .

The HPDL-1414/2416 are assembled by die attaching and wire bonding the four GaAsP/GaAs monolithic LED chips and the CMOS IC to a high temperature printed circuit board. An immersion lens is formed by placing the PC board assembly into a nylon lens filled with epoxy. A plastic cap creates an air gap to protect the CMOS IC. Backfill epoxy environmentally seals the display package. This package construction provides the display with a high tolerance to temperature cycling.

The inputs to the CMOS IC are protected against static discharge and input current latchup. However, for best results standard CMOS handling precautions should be used. Prior to use, the HPDL-1414/2416 should be stored in anti-static tubes or conductive material. During assembly a grounded conductive work area should be used, and assembly personnel should wear conductive wrist straps. Lab coats made of synthetic material should be avoided since they are prone to static charge build-up. Input current latchup is caused when the CMOS inputs are subjected either to a voltage below ground ( $V_{IN} < \text{ground}$ ) or to a voltage higher than  $V_{DD}$  ( $V_{IN} > V_{DD}$ ) and when a high current is forced into the input. To prevent input current latchup and ESD damage, unused inputs should be connected either to ground or to  $V_{DD}$ . Voltages should not be applied to the inputs until  $V_{DD}$  has been applied to the display. Transient input voltages should be eliminated.

### **Soldering and Post Solder Cleaning Instructions**

The HPDL-1414/2416 may be hand soldered or wave soldered with SN63 solder. Hand soldering may be safely performed only with an electronically temperature-controlled and securely grounded soldering iron. For best results, the iron tip temperature should be set at

315°C (600°F). For wave soldering, a rosin-based RMA flux can be used. The solder wave temperature should be 245°C ± 5°C (473°F ± 9°F), and the dwell in the wave should be set at 1½ to 3 seconds for optimum soldering. Preheat temperature should not exceed 93°C (200°F) as measured on the solder side of the PC board.

For further information on soldering and post solder cleaning, see Application Note 1027, *Soldering LED Components*.

# Hexadecimal and Numeric Indicators

## Technical Data

**5082-7300**  
**5082-7302**  
**5082-7304**  
**5082-7340**

### Features

- **Numeric 5082-7300/-7302**  
 0-9, Test State, Minus Sign, Blank States  
 Decimal Point  
 7300 Right Hand D.P.  
 7302 Left Hand D.P.
- **Hexadecimal 5082-7340**  
 0-9, A-F, Base 16 Operation  
 Blanking Control, Conserves Power  
 No Decimal Point
- **DTL/TTL Compatible**
- **Includes Decoder/Driver With 5-Bit Memory**  
 8421 Positive Logic Input
- **4 x 7 Dot Matrix Array**  
 Shaped Character, Excellent Readability

- **Standard Dual-in-Line Package Including Contrast Filter**  
 15.2 mm x 10.2 mm (0.6 inch x 0.4 inch)
- **Categorized for Luminous Intensity**  
 Assures Uniformity of Light Output From Unit to Unit Within a Single Category

### Description

Hewlett-Packard's 5082-7300 series solid state numeric and hexadecimal indicators with on-board decoder/driver and memory provide 7.4 mm (0.29 inch) displays for reliable, low-cost methods of displaying digital information.

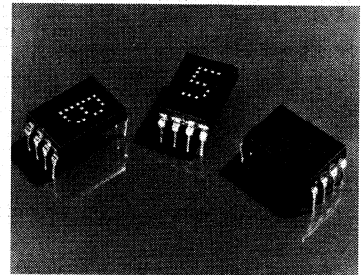

ALPHANUMERIC DISPLAYS

The 5082-7300 numeric indicator decodes positive 8421 BCD logic inputs into characters 0-9, a "—" sign, a test pattern, and four blanks in the invalid BCD states. The unit employs a right-hand decimal point.

### Package Dimensions

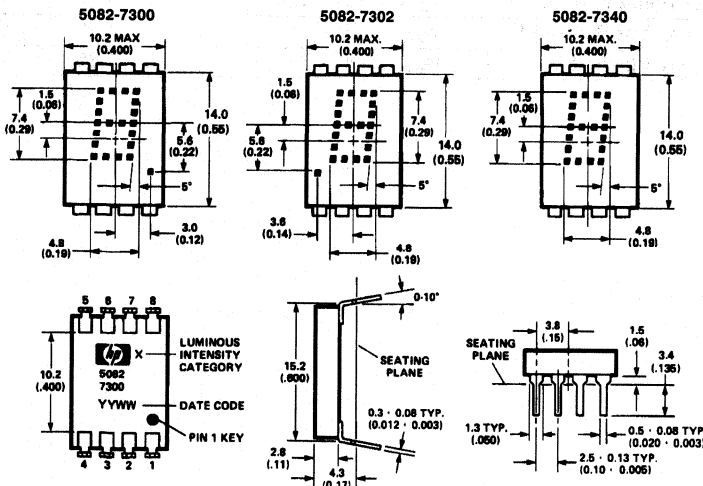

Pin	Function	
	5082-7300 and 7302 Numeric	5082-7340 Hexadecimal
1	Input 2	Input 2
2	Input 4	Input 4
3	Input 8	Input 8
4	Decimal Point	Blanking Control
5	Latch Enable	Latch Enable
6	Ground	Ground
7	V <sub>CC</sub>	V <sub>CC</sub>
8	Input 1	Input 1

- Notes:**
1. Dimensions in millimeters and (inches).
  2. Unless otherwise specified, the tolerance on all dimensions is  $\pm 0.38$  mm ( $\pm 0.015$  inch).
  3. Digit center line is  $\pm 0.25$  mm ( $\pm 0.01$  inch) from package center line.

The 5082-7302 is the same as the 5082-7300, except that the decimal point is located on the left-hand side of the digit.

The 5082-7340 hexadecimal indicator decodes positive 8421 logic inputs into 16 states, 0-9 and A-F. In place of the decimal point

an input is provided for blanking the display (all LEDs off), without losing the contents of the memory. Applications include terminals and computer systems using the base-16 character set.

The 5082-7304 is a ( $\pm 1$ ) overrange display including a right-hand decimal point.

### Applications

Typical applications include point-of-sale terminals, instrumentation, and computer systems.

### Absolute Maximum Ratings

Description	Symbol	Min.	Max.	Unit
Storage Temperature, Ambient	$T_s$	-40	+100	°C
Operating Temperature, Case	$T_c$	-20	+85	°C
$V_{CC}$ Pin Potential to Ground Pin	$V_{CC}$	-0.5	+7.0	V
Voltage Applied to Input Logic Pins and Decimal Point <sup>[1]</sup>				
Voltage Applied to Latch Enable	$V_E$	-0.5	+5.5	V
Voltage Applied to Blanking Control <sup>[2]</sup>	$V_B$	-0.5	+5.5	V

**Notes:**

1. Decimal point applies only to 7300/7302.
2. Applies only to 7340.

### Recommended Operating Conditions

Description	Symbol	Min.	Nom.	Max.	Unit
Supply Voltage	$V_{CC}$	4.5	5.0	5.5	V
Logic Voltage "0" State	$V_{IN(0)}$	0		0.8	V
Logic Voltage "1" State	$V_{IN(1)}$	2.0		5.25	V
Latch Enable Voltage – Data Being Entered	$V_{E(0)}$	0		0.8	V
Latch Enable Voltage – Data Not Being Entered	$V_{E(1)}$	2.0		5.25	V
Blanking Control Voltage – Display Not Blanked <sup>[1]</sup>	$V_{B(0)}$	0		0.8	V
Blanking Control Voltage – Display Blanked <sup>[1]</sup>	$V_{B(1)}$	3.5		5.25	V

**Note:**

1. Applies only to 7340.



**Electrical/Optical Characteristics** ( $T_A = -20^{\circ}\text{C}$  to  $+85^{\circ}\text{C}$ , Unless Otherwise Specified)

Description	Symbol	Test Conditions	Min.	Typ.	Max.	Unit
Supply Current	$I_{CC}$	$V_{CC} = 5.5\text{ V}$		94 <sup>[1]</sup>	170 <sup>[2]</sup>	mA
Power Dissipation	$P_T$	$V_{CC} = 5.5\text{ V}$		470 <sup>[1]</sup>	935 <sup>[2]</sup>	mW
Luminous Intensity per LED (Digit Average) <sup>[3]</sup>	$I_V$	$V_{CC} = 5.5\text{ V}, T_C = 25^{\circ}\text{C}$	32	70		$\mu\text{cd}$
Minimum Time Data Must Be Presented to Logic Input Prior to Enable Rising	$t_{SETUP}$	$V_{CC} = 5.0\text{ V}, V_{E(0)} = 0.4\text{ V}$ $V_{IN(0)} = 0.4\text{ V}, V_{E(1)} = 2.4\text{ V}$ $V_{IN(1)} = 2.4\text{ V}, T_C = 25^{\circ}\text{C}$		30	50	ns
Minimum Time Data Must Be Held After Enable Rises	$t_{HOLD}$	$V_{CC} = 5.0\text{ V}, V_{E(0)} = 0.4\text{ V}$ $V_{IN(0)} = 0.4\text{ V}, V_{E(1)} = 2.4\text{ V}$ $V_{IN(1)} = 2.4\text{ V}, T_C = 25^{\circ}\text{C}$		30	50	ns
Time Required for 90% Change in Display Luminous Intensity After Change of State of $F_B$ <sup>[4]</sup>	$t_{BLANK}$	$V_{CC} = 5.0\text{ V}, T_C = 25^{\circ}\text{C}$			500	ns
Blanking Control Current "0" State <sup>[4]</sup>	$I_{B(0)}$	$V_{CC} = 5.5\text{ V}, V_{B(0)} = 0.8\text{ V}$			200	$\mu\text{A}$
Blanking Control Current "1" State <sup>[4]</sup>	$I_{B(1)}$	$V_{CC} = 5.5\text{ V}, V_{B(1)} = 4.5\text{ V}$			2.0	mA
Logic and Latch Enable Currents "0" State	$I_{IN(0)},$ $I_{E(0)}$	$V_{CC} = 5.5\text{ V}$ $V_{IN}, V_E = 0.4\text{ V}$			-1.6	mA
Logic and Latch Enable Currents "1" State	$I_{IN(1)},$ $I_{E(1)}$	$V_{CC} = 5.5\text{ V}$ $V_{IN}, V_E = 2.4\text{ V}$			+250	$\mu\text{A}$
Peak Wavelength	$\lambda_{PEAK}$	$T_C = 25^{\circ}\text{C}$		655		nm
Spectral Halfwidth	$\Delta\lambda_{1/2}$	$T_C = 25^{\circ}\text{C}$		30		nm
Weight				0.8		gm

**Notes:**

- $V_{CC} = 5.0\text{ V}$  with statistical average number of LEDs lit.
- Worst case condition excluding test state on 5082-7300/-7302.
- The digits are categorized for luminous intensity such that the variation from digit to digit within a category is not discernible to the eye. Intensity categories are designated by a letter located on the reverse side of the package contiguous with the Hewlett-Packard logo marking.
- Applies only to -7340.

**Truth Table for 5082-7300 Series Devices**

Character		Input						Character	Inputs						
5082-7300/7302 Numeric	5082-7340 Hex.	X8	X4	X2	X1	E	B <sup>[1]</sup>	5082-7300/7302 Numeric	5082-7340 Hex.	X8	X4	X2	X1	E	B <sup>[1]</sup>
0	0	L	L	L	L	L		Test	A	H	L	H	L	L	L
1	1	L	L	L	H	L	L	Blank	B	H	L	H	H	L	L
2	2	L	L	H	H	L	L	Minus	D	H	H	L	H	L	L
3	3	L	L	H	H	L	L	Minus	D	H	H	L	H	L	L
4	4	L	H	L	L	L	L	Blank	E	H	H	H	L	L	L
5	5	L	H	L	H	L	L	Blank	F	H	H	H	H	L	L
6	6	L	H	H	L	L	L	Hold	Hold	d	d	d	d	H	d
7	7	L	H	H	H	L	L	-	Blank <sup>[1]</sup>	d	d	d	d	d	H
8	8	H	L	L	L	L	L	Decimal pt. on <sup>[2]</sup>	-	DP <sub>IN</sub> = L					
9	9	H	L	L	H	L	L	Decimal pt. off <sup>[2]</sup>	-	DP <sub>IN</sub> = H					

**Notes:**

- The blanking control input, B, pertains to the 5082-7340 Hexadecimal Indicator only.
- The decimal point input pertains to the 5082-7300 and -7302 Numeric Indicators only.
- H = logic '1'; L = logic '0'; d = 'don't care.'

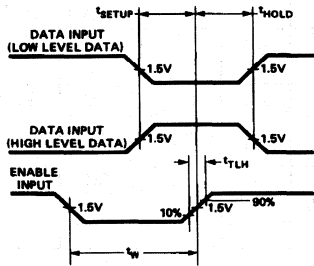

Figure 1. Timing Diagram of 5082-7300 Series Logic.

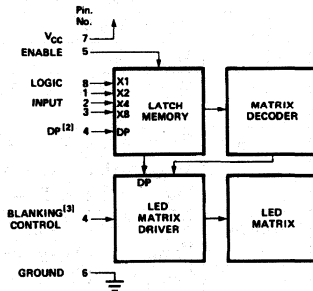

Figure 2. Block Diagram of 5082-7300 Series Logic.

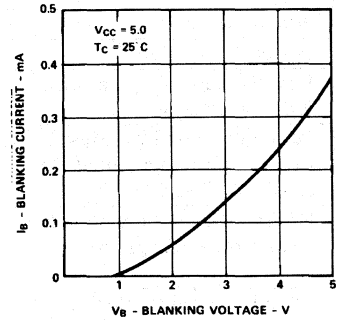

Figure 3. Typical Blanking Control Current vs. Voltage for 5082-7340 Only.

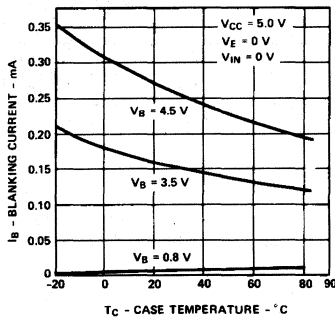

Figure 4. Typical Blanking Control Input Current vs. Ambient Temperature, 5082-7340.

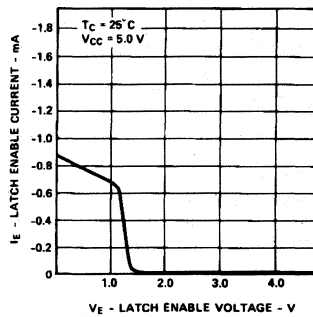

Figure 5. Typical Latch Enable Input Current vs. Voltage for the 5082-7300 Series Devices.

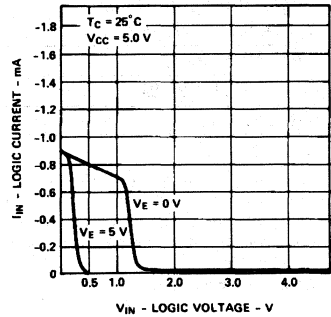

Figure 6. Typical Logic and Decimal Point Input Current vs. Voltage for the 5082-7300 Series Devices. Decimal Point Applies to 5082-7300 and -7302 Only.

TRUTH TABLE					
BCD DATA <sup>(1)</sup>				5082-7300/7302	5082-7340
X <sub>8</sub>	X <sub>4</sub>	X <sub>2</sub>	X <sub>1</sub>		
L	L	L	L	0	0
L	L	L	H	1	1
L	L	H	L	2	2
L	L	H	H	3	3
L	H	L	L	4	4
L	H	L	H	5	5
L	H	H	L	6	6
L	H	H	H	7	7
H	L	L	L	8	8
H	L	L	H	9	9
H	L	H	L	A	A
H	L	H	H	(BLANK)	B
H	H	L	L	(BLANK)	C
H	H	L	H	----	D
H	H	H	L	(BLANK)	E
H	H	H	H	(BLANK)	F
DECIMAL PT. <sup>(2)</sup>	ON	V <sub>DP</sub> = L			
	OFF	V <sub>DP</sub> = H			
ENABLE <sup>(1)</sup>	LOAD DATA	V <sub>E</sub> = L			
	LATCH DATA	V <sub>E</sub> = H			
BLANKING <sup>(3)</sup>	DISPLAY-ON	V <sub>B</sub> = L			
	DISPLAY-OFF	V <sub>B</sub> = H			

### Solid State Over Range Character

For display applications requiring a ±, 1, or decimal point designation, the 5082-7304 over range character is available. This display module comes in the same package as the 5082-7300 series numeric indicator and is completely compatible with it.

**Notes:**

- H = Logic High; L = Logic Low. With the enable input at logic high changes in BCD input logic levels or D.P. input have no effect upon display memory, displayed character, or D.P.
- The decimal point input, DP, pertains only to the 5082-7300 and 5082-7302 displays.
- The blanking control input, B, pertains only to the 5082-7340 hexadecimal display. Blanking input has no effect upon display memory.

### Package Dimensions

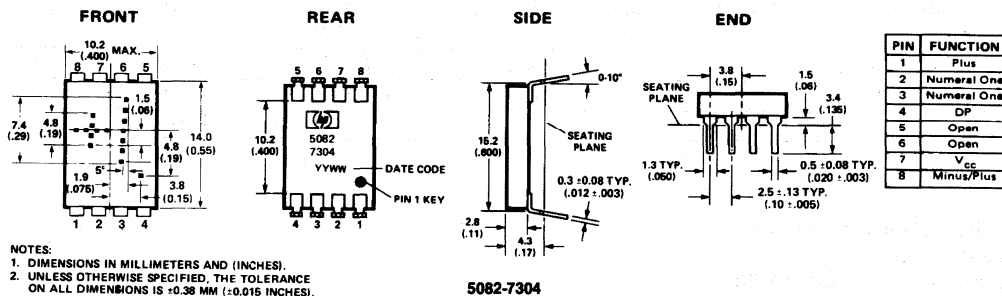

5082-7304

### Truth Table for 5082-7304

Character	Pin			
	1	2, 3	4	8
+	1	d	d	1
-	0	d	d	1
1	d	1	d	d
Decimal Point	d	d	1	d
Blank	0	0	0	0

**Notes:**

- L: Line switching transistor in Figure 7 cutoff.  
 H: Line switching transistor in Figure 7 saturated.  
 X: 'Don't care.'

### Typical Driving Circuit for 5082-7304

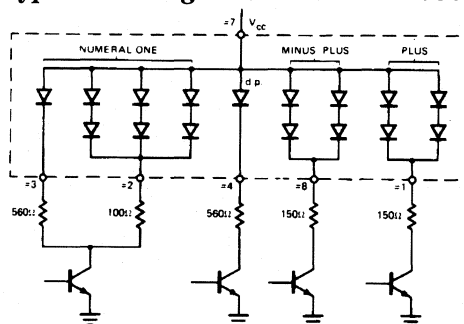

Figure 7.

## Absolute Maximum Ratings

Description	Symbol	Min.	Max.	Unit
Storage Temperature, Ambient	$T_S$	-40	+100	°C
Operating Temperature, Case	$T_C$	-20	+85	°C
Forward Current, Each LED	$I_F$		10	mA
Reverse Voltage, Each LED	$V_R$		4	V

## Recommended Operating Conditions

Description	Symbol	Min.	Nom.	Max.	Unit
LED Supply Voltage	$V_{CC}$	4.5	5.0	5.5	V
Forward Current, Each LED	$I_F$		5.0	10	mA

**Note:**

LED current must be externally limited. Refer to Figure 7 for recommended resistor values.

## Recommended Operating Conditions

( $T_A = -20^\circ\text{C}$  to  $70^\circ\text{C}$ , Unless Otherwise Specified)

Description	Symbol	Test Conditions	Min.	Typ.	Max.	Unit
Forward Voltage per LED	$V_F$	$I_F = 10\text{ mA}$		1.6	2.0	V
Power Dissipation	$P_T$	$I_F = 10\text{ mA}$ All Diodes Lit		250	320	mW
Luminous Intensity per LED (Digit Average)	$I_V$	$I_F = 6\text{ mA}$ $T_C = 25^\circ\text{C}$	32	70		$\mu\text{cd}$
Peak Wavelength	$\lambda_{\text{PEAK}}$	$T_C = 25^\circ\text{C}$		655		nm
Dominant Wavelength	$\lambda_d$	$T_C = 25^\circ\text{C}$		30		nm
Weight				0.8		gm

For further information concerning electrical and mechanical implementation of the 5082-7300 series devices, please refer to Application Note 934.

# Hexadecimal and Numeric Displays for Industrial Applications

## Technical Data

**HDSP-076X Series**  
**HDSP-077X Series**  
**HDSP-086X Series**  
**HDSP-096X Series**

### Features

- **Three Colors**
  - High-Efficiency Red
  - Yellow
  - High Performance Green
- **Two High-Efficiency Red Options**
  - Low Power
  - High Brightness
- **Three Character Options**
  - Numeric
  - Hexadecimal
  - Over Range
- **Performance Guaranteed over Temperature**

- **Memory Latch/Decoder/Driver**
  - TTL Compatible
- **4 x 7 Dot Matrix Character**
- **Categorized for Luminous Intensity**
- **Yellow and Green Categorized for Color**

### Typical Applications

- **Industrial Equipment**
- **Computer Peripherals**
- **Instrumentation**
- **Telecommunication Equipment**

### Device Selection Guide

Part Number HDSP-	Color	Description	Front View
0760	High-Efficiency	Numeric, Right Hand DP	A
0761	Red	Numeric, Left Hand DP	B
0762	Low Power	Hexadecimal	C
0763		Over Range $\pm 1$	D
0770	High-Efficiency	Numeric, Right Hand DP	A
0771	Red	Numeric, Left Hand DP	B
0772	High Brightness	Hexadecimal	C
0763		Over Range $\pm 1$	D
0860	Yellow	Numeric, Right Hand DP	A
0861		Numeric, Left Hand DP	B
0862		Hexadecimal	C
0863		Over Range $\pm 1$	D
0960	Green	Numeric, Right Hand DP	A
0961		Numeric, Left Hand DP	B
0962		Hexadecimal	C
0963		Over Range $\pm 1$	D

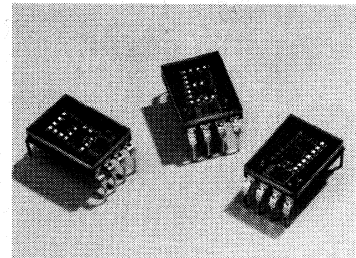

ALPHANUMERIC DISPLAYS

### Description

These solid state display devices are designed and tested for use in adverse industrial environments. The character height is 7.4 mm (0.29 inch). The numeric and hexadecimal devices incorporate an on-board IC that contains the data memory, decoder and display driver functions.

The numeric BCD devices decode positive BCD logic into characters "0-9", a "-" sign, decimal point, and a test pattern. The hexadecimal devices decode positive BCD logic into 16 characters, "0-9, A-F." An input is provided on the hexadecimal devices to blank the display (all LEDs off) without losing the contents of the memory.

The over range device displays " $\pm 1$ " and right hand decimal point and is typically driven via external switching transistors.

# Package Dimensions

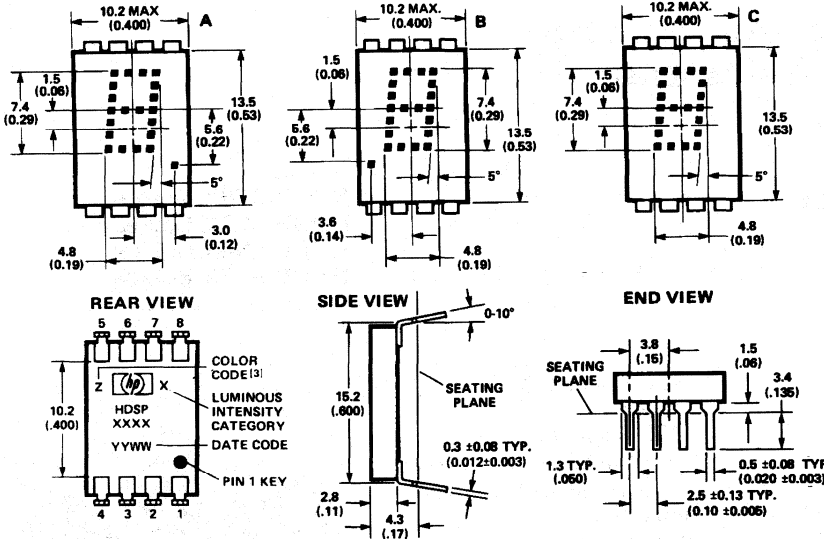

PIN	FUNCTION	
	NUMERIC	HEXA-DECIMAL
1	Input 2	Input 2
2	Input 4	Input 4
3	Input 8	Input 8
4	Decimal point	Blanking control
5	Latch enable	Latch enable
6	Ground	Ground
7	V <sub>CC</sub>	V <sub>CC</sub>
8	Input 1	Input 1

- NOTES:  
 1. Dimensions in millimetres and (inches).  
 2. Digit center line is ±0.38 mm (±0.015 inch) from package center line.  
 3. Unless otherwise specified, the tolerance on all dimensions is ±0.38 mm (±0.015 inch).  
 4. HDSP-0860 and HDSP-0860 series.

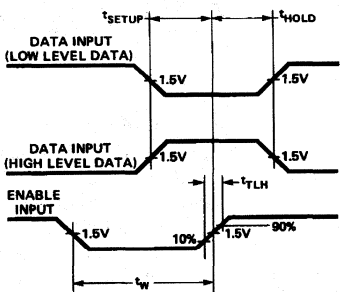
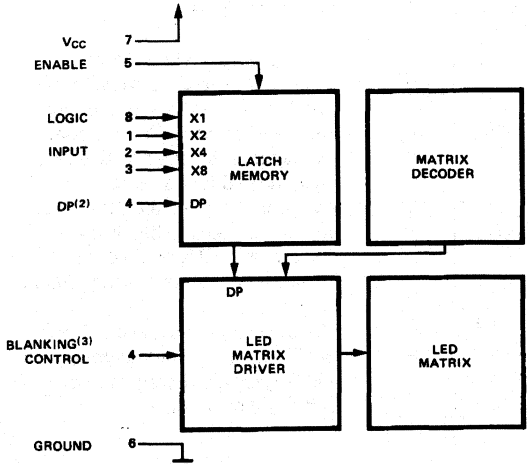

Figure 1. Timing Diagram

BCD DATA <sup>(1)</sup>				TRUTH TABLE	
X <sub>8</sub>	X <sub>4</sub>	X <sub>2</sub>	X <sub>1</sub>	NUMERIC	HEXA-DECIMAL
L	L	L	L	0	0
L	L	L	H	1	1
L	L	H	L	2	2
L	L	H	H	3	3
L	H	L	L	4	4
L	H	L	H	5	5
L	H	H	L	6	6
L	H	H	H	7	7
H	L	L	L	8	8
H	L	L	H	9	9
H	L	H	L	(BLANK)	0
H	L	H	H	(BLANK)	0
H	H	L	L	(BLANK)	0
H	H	L	H	(BLANK)	0
H	H	H	L	(BLANK)	0
H	H	H	H	(BLANK)	0
DECIMAL PT. <sup>(2)</sup>				ON	V <sub>DP</sub> = L
DECIMAL PT. <sup>(2)</sup>				OFF	V <sub>DP</sub> = H
ENABLE <sup>(1)</sup>				LOAD DATA	V <sub>E</sub> = L
ENABLE <sup>(1)</sup>				LATCH DATA	V <sub>E</sub> = H
BLANKING <sup>(3)</sup>				DISPLAY-ON	V <sub>B</sub> = L
BLANKING <sup>(3)</sup>				DISPLAY-OFF	V <sub>B</sub> = H



- Notes:  
 1. H = Logic High; L = Logic Low. With the enable input at logic high changes in BCD input logic levels have no effect upon display memory, displayed character, or DP.  
 2. The decimal point input, DP, pertains only to the numeric displays.  
 3. The blanking control input, B, pertains only to the hexadecimal displays. Blanking input has no effect upon display memory.

Figure 2. Logic Block Diagram.

## Absolute Maximum Ratings

Description	Symbol	Min.	Max.	Unit
Storage Temperature, Ambient	$T_S$	-65	+100	°C
Operating Temperature, Ambient <sup>[1]</sup>	$T_A$	-55	+85	°C
Supply Voltage <sup>[2]</sup>	$V_{CC}$	-0.5	+7.0	V
Voltage Applied to Input Logic, dp and Enable Pins	$V_I, V_{DP}, V_E$	-0.5	$V_{CC}$	V
Voltage Applied to Blanking Input <sup>[2]</sup>	$V_B$	-0.5	$V_{CC}$	V
Maximum Solder Temperature at 1.59 mm (0.062 inch) Below Seating Plane, $t \leq 5$ seconds			260	°C

## Recommended Operating Conditions

Description	Symbol	Min.	Nom.	Max.	Unit
Supply Voltage <sup>[2]</sup>	$V_{CC}$	4.5	5.0	5.5	V
Operating Temperature, Ambient <sup>[1]</sup>	$T_A$	-55		+85	°C
Enable Pulse Width	$t_W$	100			nsec
Time Data Must Be Held Before Positive Transition of Enable Line	$t_{SETUP}$	50			nsec
Time Data Must Be Held After Positive Transition of Enable Line	$t_{HOLD}$	50			nsec
Enable Pulse Rise Time	$t_{TLH}$			1.0	msec

## Optical Characteristics at $T_A = 25^\circ\text{C}$ , $V_{CC} = 5.0\text{ V}$

Device	Description	Symbol	Min.	Typ.	Max.	Unit
HDSP-0760 Series	Luminous Intensity per LED (Digit Average) <sup>[3,4]</sup>	$I_V$	65	140		$\mu\text{cd}$
	Peak Wavelength	$\lambda_{PEAK}$		635		nm
	Dominant Wavelength <sup>[5]</sup>	$\lambda_d$		626		nm
HDSP-0770 Series	Luminous Intensity per LED (Digit Average) <sup>[3,4]</sup>	$I_V$	260	620		$\mu\text{cd}$
	Peak Wavelength	$\lambda_{PEAK}$		635		nm
	Dominant Wavelength <sup>[5]</sup>	$\lambda_d$		626		nm
HDSP-0860 Series	Luminous Intensity per LED (Digit Average) <sup>[3,4]</sup>	$I_V$	215	490		$\mu\text{cd}$
	Peak Wavelength	$\lambda_{PEAK}$		583		nm
	Dominant Wavelength <sup>[5,6]</sup>	$\lambda_d$		585		nm
HDSP-0960 Series	Luminous Intensity per LED (Digit Average) <sup>[3,4]</sup>	$I_V$	298	1100		$\mu\text{cd}$
	Peak Wavelength	$\lambda_{PEAK}$		568		nm
	Dominant Wavelength <sup>[5,6]</sup>	$\lambda_d$		574		nm

### Notes:

- The nominal thermal resistance of a display mounted in a socket that is soldered onto a printed circuit board is  $R_{\theta_{JA}} = 50^\circ\text{C/W}$ /device. The device package thermal resistance is  $R_{\theta_{J-PIN}} = 15^\circ\text{C/W}$ /device. The thermal resistance device pin-to-ambient through the PC board should not exceed  $35^\circ\text{C/W}$ /device for operation at  $T_A = +85^\circ\text{C}$ .
- Voltage values are with respect to device ground, pin 6.
- These displays are categorized for luminous intensity with the intensity category designated by a letter code located on the back of the display package. Case temperature of the device immediately prior to the light measurement is equal to  $25^\circ\text{C}$ .

**Electrical Characteristics;**  $T_A = -55^\circ\text{C}$  to  $+85^\circ\text{C}$

Description	Symbol	Test Conditions	Min.	Typ. <sup>[7]</sup>	Max.	Unit
Supply Current HDSP-0760 Series	$I_{CC}$	$V_{CC} = 5.5\text{ V}$ (Characters "5." or "B" Displayed)		78	105	mA
HDSP-0770 Series HDSP-0860 Series HDSP-0960 Series				120	175	
Power Dissipation HDSP-0760 Series			$P_T$		390	
HDSP-0770 Series HDSP-0860 Series HDSP-0960 Series		690		963		
Logic, Enable and Blanking Low-Level Input Voltage	$V_{IL}$	$V_{CC} = 4.5\text{ V}$				0.8
Logic, Enable and Blanking High-Level Input Voltage	$V_{IH}$		2.0			V
Logic and Enable Low-Level Input Current	$I_{IL}$	$V_{CC} = 5.5\text{ V}$			-1.6	mA
Blanking Low-Level Input Current	$I_{BL}$	$V_{IL} = 0.4\text{ V}$			-10	$\mu\text{A}$
Logic, Enable and Blanking High-Level Input Current	$I_{IH}$	$V_{CC} = 5.5\text{ V}$ $V_{IH} = 2.4\text{ V}$			+40	$\mu\text{A}$
Weight				1.0		gm
Leak Rate					$5 \times 10^{-8}$	cc/sec

**Notes:**

4. The luminous intensity at a specific operating ambient temperature,  $I_V(T_A)$  may be approximated from the following exponential equation:  $I_V(T_A) = I_V(25^\circ\text{C}) e^{[k(T_A - 25^\circ\text{C})]}$ .

Device	K
HDSP-0760 Series	-0.0131/ $^\circ\text{C}$
HDSP-0770 Series	-0.0112/ $^\circ\text{C}$
HDSP-0860 Series	-0.0112/ $^\circ\text{C}$
HDSP-0960 Series	-0.0104/ $^\circ\text{C}$

- The dominant wavelength,  $\lambda_{dt}$ , is derived from the CIE Chromaticity Diagram and is that single wavelength which defines the color of the device.
- The HDSP-0860 and HDSP-0960 series devices are categorized as to dominant wavelength with the category designated by a number on the back of the display package.
- All typical values at  $V_{CC} = 5.0\text{ V}$  and  $T_A = 25^\circ\text{C}$ .



## Operational Considerations

### Electrical

These devices use a modified 1 x 7 dot matrix light emitting diode to display decimal/hexadecimal numeric information. The high efficiency red and yellow LEDs are GaAsP epitaxial layer on a GaP transparent substrate. The green LEDs are GaP epitaxial layer on a GaP transparent substrate. The LEDs are driven by constant current drivers, BCD information is accepted by the display memory when the enable line is at logic low and the data is latched when the enable is at logic high. Using the enable pulse width and data setup and hold times listed in the Recommended Operating Conditions allows data to be clocked into an array of displays at a 6.7 MHz rate.

The decimal point input is active low true and this data is latched into the display memory in the same fashion as the BCD data. The decimal point LED is driven by the on-board IC.

The blanking control input on the hexadecimal displays blanks (turns off) the displayed information without disturbing the contents of display memory. The display is blanked at a minimum threshold level of 2.0 volts. When blanked, the display standby power is nominally 250 mW at  $T_A = 25^\circ\text{C}$ .

### Mechanical

The primary thermal path for power dissipation is through the device leads. Therefore, to insure reliable operation up to an ambient temperature of  $+85^\circ\text{C}$ , it is important to maintain a case-to-ambient thermal resistance of less than  $35^\circ\text{C}$  watt/device as measured on top of display pin 3.

For information on soldering and post solder cleaning see Application Note 1027, *Soldering LED Components*.

### Contrast Enhancement

These display devices are designed to provide an optimum ON/OFF contrast when placed behind an appropriate contrast enhancement filter. For further information, please refer to Application Note 1015, *Contrast Enhancement Techniques for LED Displays*.

### Over Range Display

The over range devices display "± 1" and decimal point. The character height and package configuration are the same as the numeric and hexadecimal devices. Character selection is obtained via external switching transistors and current limiting resistors.

## Package Dimensions

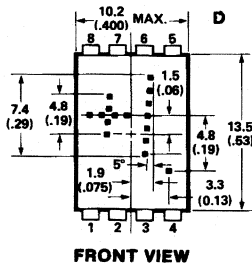

NOTE: 1. DIMENSIONS IN MILLIMETRES AND (INCHES).

Pin	Function
1	Plus
2	Numeral One
3	Numeral One
4	DP.
5	Open
6	Open
7	V <sub>CC</sub>
8	Minus/Plus

Character	Pin			
	1	2,3	4	8
+	1	X	X	1
-	0	X	X	1
1	X	1	X	X
Decimal Point	X	X	1	X
Blank	0	0	0	0

#### Notes:

- 0: Line switching transistor in Figure 7 cutoff.
- 1: Line switching transistor in Figure 7 saturated.
- X: 'don't care'

### Absolute Maximum Ratings

Description	Symbol	Min.	Max.	Unit
Storage Temperature, Ambient	$T_S$	-65	+100	°C
Operating Temperature, Ambient	$T_A$	-55	+85	°C
Forward Current, Each LED	$I_F$		10	mA
Reverse Voltage, Each LED	$V_R$		5	V

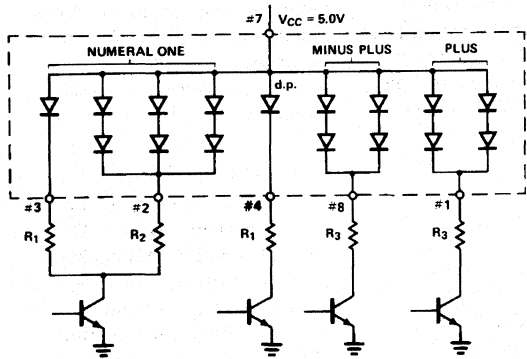

Figure 3. Typical Driving Circuit.

### Recommended Operating Conditions $V_{CC} = 5.0\text{ V}$

Device	Forward Current Per LED, mA	Resistor Value			
		$R_1$	$R_2$	$R_3$	
HDSP-0763	Low Power	2.8	1300	200	300
	High Brightness	8	360	47	68
HDSP-0863	8	360	36	56	
HDSP-0963	8	360	30	43	

### Luminous Intensity per LED

(Digit Average)<sup>[3,4]</sup> at  $T_A = 25^\circ\text{C}$

Device	Test Conditions	Min.	Typ.	Units
HDSP-0763	$I_F = 2.8\text{ mA}$	65	140	$\mu\text{cd}$
	$I_F = 8\text{ mA}$		620	$\mu\text{cd}$
HDSP-0863	$I_F = 8\text{ mA}$	215	490	$\mu\text{cd}$
HDSP-0963	$I_F = 8\text{ mA}$	298	1100	$\mu\text{cd}$

**Electrical Characteristics:**  $T_A = -55^\circ\text{C}$  to  $+85^\circ\text{C}$

Device	Description	Symbol	Test Conditions	Min.	Typ.	Max.	Unit
HDSP-0763	Power Dissipation (All LEDs illuminated)	$P_T$	$I_F = 2.8 \text{ mA}$		72		mW
			$I_F = 8 \text{ mA}$		224	282	
	Forward Voltage per LED	$V_F$	$I_F = 2.8 \text{ mA}$		1.6		V
			$I_F = 8 \text{ mA}$		1.75	2.2	
HDSP-0863	Power Dissipation (All LEDs illuminated)	$P_T$	$I_F = 8 \text{ mA}$		237	282	mW
	Forward Voltage per LED	$V_F$			1.90	2.2	V
HDSP-0963	Power Dissipation (All LEDs illuminated)	$P_T$	$I_F = 8 \text{ mA}$		243	282	mW
	Forward Voltage per LED	$V_F$			1.85	2.2	V

# Large 5 X 7 Dot Matrix Alphanumeric Displays 17.3/26.5 mm Character Heights

## Technical Data

**HDSP-440X Series**  
**HDSP-450X Series**  
**HDSP-470X Series**  
**HDSP-510X Series**  
**HDSP-540X Series**  
**HDSP-L10X Series**  
**HDSP-L20X Series**  
**HDSP-M10X Series**

### Features

- Multiple Colors Available
- Large Character Height
- 5 X 7 Dot Matrix Font
- Viewable Up to 18 Meters (26.5 mm Display)
- X-Y Stackable
- Ideal for Graphics Panels
- Available in Common Row Anode and Common Row Cathode Configurations
- AlGaAs Displays Suitable for Low Power or Bright Ambients

Typical Intensity 1650 mcd  
at 2 mA Average Drive  
Current

- Categorized for Intensity
- Mechanically Rugged
- Green Categorized for Color

### Description

The large 5 X 7 dot matrix alphanumeric display family consists of 26.5 mm (1.04 inch) and 17.3 mm (0.68 inch) character height packages. These devices have excellent viewability; the 26.5 mm character can be read at up to 18 meters (12 meters for the 0.68 inch part).

The 26.5 mm font has a 10.2 mm (0.4 inch) dual-in-line (DIP) configuration, while the 17.3 mm font has an industry standard 7.6 mm (0.3 inch) DIP configuration.

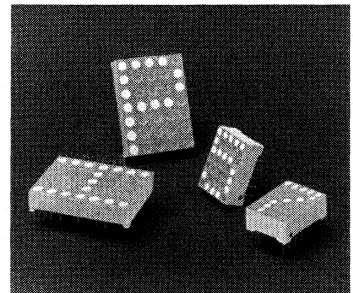

Applications include electronic instrumentation, computer peripherals, point of sale terminals, weighing scales, and industrial electronics.

### Devices

Standard Red	AlGaAs Red	High Efficiency Red	High Performance Green	Description
HDSP-4701	HDSP-L101	HDSP-L201	HDSP-5401	17.3 mm Common Row Anode
HDSP-4703	HDSP-L103	HDSP-L203	HDSP-5403	17.3 mm Common Row Cathode
HDSP-4401	HDSP-M101	HDSP-4501	HDSP-5101	26.5 mm Common Row Anode
HDSP-4403	HDSP-M103	HDSP-4503	HDSP-5103	26.5 mm Common Row Cathode

# Package Dimensions

## HDSP-470X/L10X/L20X/540X Series

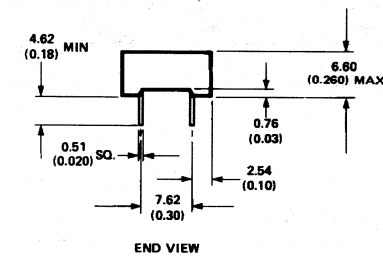
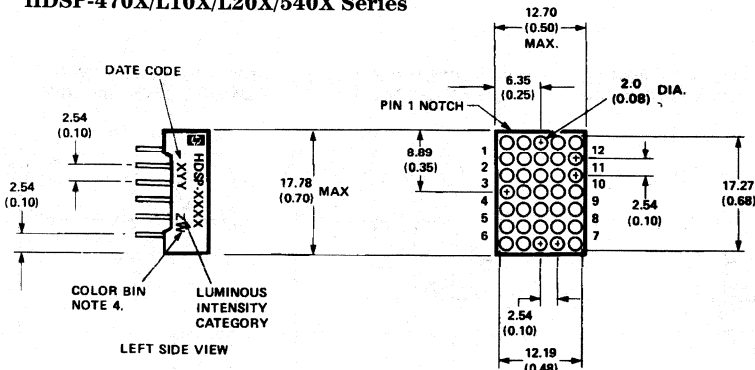

PIN	FUNCTION	
	HDSP-4701/5401/ L101/L201	HDSP-4703/5403/ L103/L203
1	COLUMN 1 CATHODE	ROW 1 CATHODE
2	ROW 3 ANODE	ROW 2 CATHODE
3	COLUMN 2 CATHODE	COLUMN 2 ANODE
4	ROW 5 ANODE	COLUMN 1 ANODE
5	ROW 6 ANODE	ROW 6 CATHODE
6	ROW 7 ANODE	ROW 7 CATHODE
7	COLUMN 4 CATHODE	COLUMN 3 ANODE
8	COLUMN 5 CATHODE	ROW 5 CATHODE
9	ROW 4 ANODE	COLUMN 4 ANODE
10	COLUMN 3 CATHODE	ROW 4 CATHODE
11	ROW 2 ANODE	ROW 3 CATHODE
12	ROW 1 ANODE	COLUMN 5 ANODE

- NOTES:
1. ALL DIMENSIONS IN MILLIMETRES (INCHES).
  2. ALL UNTOLERANCED DIMENSIONS ARE FOR REFERENCE ONLY.
  3. A NOTCH ON SCRAMBLER SIDE DENOTES PIN 1.
  4. FOR GREEN ONLY.

ALPHANUMERIC DISPLAYS

## HDSP-440X/M10X/450X/510X Series

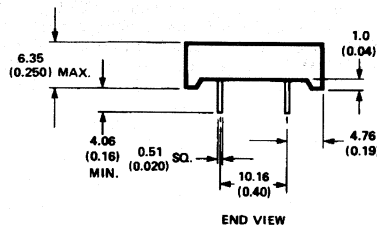
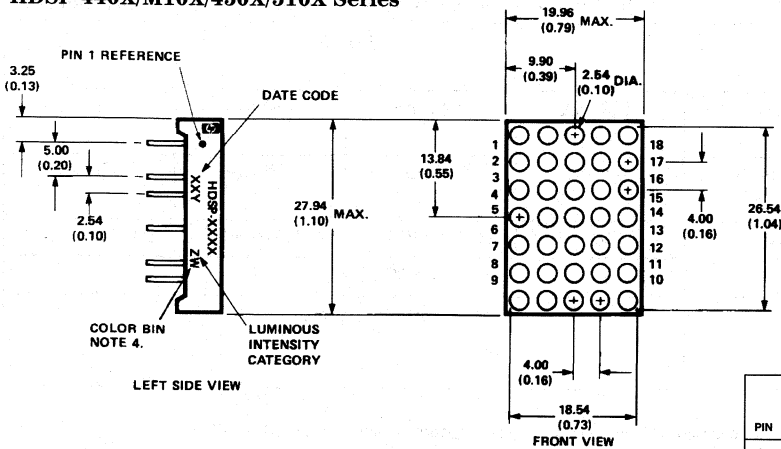

PIN	FUNCTION	
	HDSP-4401/M101/ -4501/5101	HDSP-4403/M103/ -4503/5103
1	COLUMN 1 CATHODE	ROW 1 CATHODE
2	NO PIN	NO PIN
3	ROW 3 ANODE	COLUMN 3 ANODE
4	COLUMN 2 CATHODE	ROW 3 CATHODE
5	NO PIN	NO PIN
6	ROW 5 ANODE	COLUMN 1 ANODE
7	NO PIN	NO PIN
8	ROW 6 ANODE	COLUMN 2 ANODE
9	ROW 7 ANODE	ROW 7 CATHODE
10	COLUMN 3 CATHODE	ROW 6 CATHODE
11	COLUMN 5 CATHODE	COLUMN 4 ANODE
12	NO PIN	NO PIN
13	ROW 4 ANODE	ROW 5 CATHODE
14	NO PIN	NO PIN
15	COLUMN 4 CATHODE	ROW 4 CATHODE
16	ROW 2 ANODE	ROW 2 CATHODE
17	NO PIN	NO PIN
18	ROW 1 ANODE	COLUMN 5 ANODE

- NOTES:
1. ALL DIMENSIONS IN MILLIMETRES (INCHES).
  2. ALL UNTOLERANCED DIMENSIONS ARE FOR REFERENCE ONLY.
  3. A BLACK DOT ON SCRAMBLER SIDE INDICATES PIN 1.
  4. FOR GREEN ONLY.

## Internal Circuit Diagrams

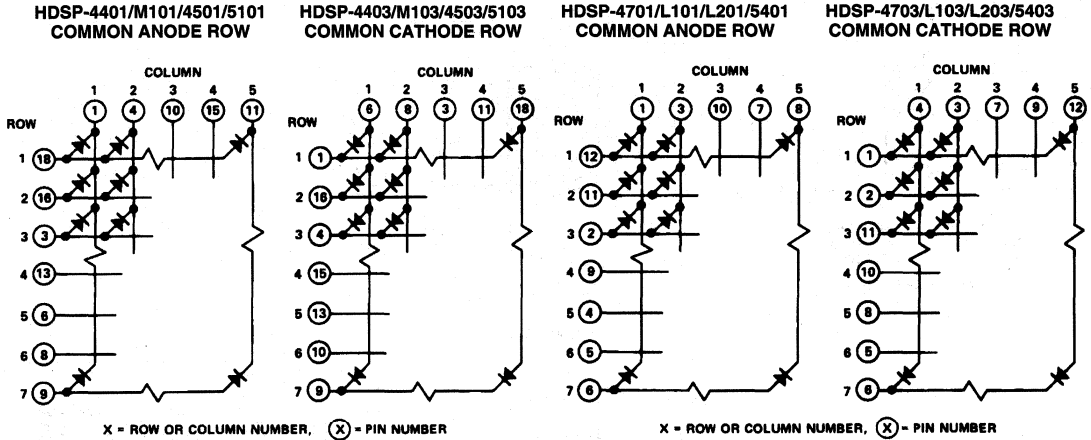

## Absolute Maximum Ratings at 25°C

Description	HDSP-470X/ 440X Series	HDSP-L10X/ M10X Series	HDSP-L20X/ 450X Series	HDSP-540X/ 510X Series
Average Power per Dot ( $T_A = 25^\circ\text{C}$ ) <sup>[1]</sup>	75 mW			
Peak Forward Current per Dot ( $T_A = 25^\circ\text{C}$ ) <sup>[1,2]</sup>	125 mA	125 mA	90 mA	90 mA
Average Forward Current per Dot ( $T_A = 25^\circ\text{C}$ ) <sup>[1,3]</sup>	32 mA	23 mA	15 mA	15 mA
Operating Temperature Range	-40°C to +85°C	-20°C to +85°C	-40°C to +85°C	-20°C to +85°C
Storage Temperature Range	-40°C to +85°C			
Lead Solder Temperature (1.59 mm [0.062 in.] below seating plane)	260°C for 3 s			

### Notes:

- Average power is based on 20 dots per character. Total package power dissipation should not exceed 1.5 W.
- Do not exceed maximum average current per dot.
- For the HDSP-440X/470X series displays, derate maximum average current above 35°C at 0.43 mA/°C. For the HDSP-L10X/M10X series displays, derate maximum average current above 35°C at 0.31 mA/°C. For the HDSP-L20X/450X series and HDSP-540X/510X series displays, derate maximum average current above 35°C at 0.2 mA/°C. This derating is based on a device mounted in a socket having a thermal resistance junction to ambient of 50°C/W per package.

## Electrical/Optical Characteristics at $T_A = 25^\circ\text{C}$

### Standard Red HDSP-440X/470X Series

Description	Symbol	Test Conditions	Min.	Typ.	Max.	Units
Luminous Intensity/Dot <sup>[4]</sup> (Digit Average) HDSP-470X (17.3 mm) HDSP-440X (26.5 mm)	$I_V$	100 mA pk: 1 of 5 Duty Factor (20 mA Avg.)	360	770		$\mu\text{cd}$
			400	800		
Peak Wavelength	$\lambda_{\text{PEAK}}$			655		nm
Dominant Wavelength <sup>[5]</sup>	$\lambda_d$			640		nm
Forward Voltage	$V_F$	$I_F = 100 \text{ mA}$		1.8	2.2	V
Reverse Voltage <sup>[6]</sup>	$V_R$	$I_R = 100 \mu\text{A}$	3.0	12		V
Temperature Coefficient of $V_F$	$\Delta V_F/^\circ\text{C}$			-2.0		mV/°C
Thermal Resistance LED Junction-to-Pin per package HDSP-470X HDSP-440X	$R\theta_{\text{J-PIN}}$			15		°C/W/ PACK
				13		

### AlGaAs Red HDSP-L10X/M10X Series

Description	Symbol	Test Conditions	Min.	Typ.	Max.	Units
Luminous Intensity/Dot <sup>[4]</sup> (Digit Average) HDSP-L10X (17.3 mm) HDSP-M10X (26.5 mm)	$I_V$	10 mA pk: 1 of 5 Duty Factor (2 mA Avg.)	730	1650		$\mu\text{cd}$
			760	1850		
Luminous Intensity/Dot <sup>[4]</sup> (Digit Average) HDSP-L10X HDSP-M10X	$I_V$	30 mA pk: 1 of 14 Duty Factor (2.1 mA Avg.)		1750		$\mu\text{cd}$
				1980		
Peak Wavelength	$\lambda_{\text{PEAK}}$			645		nm
Dominant Wavelength <sup>[5]</sup>	$\lambda_d$			637		nm
Forward Voltage	$V_F$	$I_F = 10 \text{ mA}$		1.7	2.1	V
Reverse Voltage <sup>[6]</sup>	$V_R$	$I_R = 100 \mu\text{A}$	3.0	15.0		V
Temperature Coefficient of $V_F$	$\Delta V_F/^\circ\text{C}$			-2.0		mV/°C
Thermal Resistance LED Junction-to-Pin per package HDSP-L10X HDSP-M10X	$R\theta_{\text{J-PIN}}$			20		°C/W/ PACK
				18		

### High Efficiency Red HDSP-450X/L20X Series

Description	Symbol	Test Conditions	Min.	Typ.	Max.	Units
Luminous Intensity/Dot <sup>[4]</sup> (Digit Average) HDSP-L20X (17.3 mm) HDSP-450X (26.5 mm)	I <sub>V</sub>	50 mA pk: 1 of 5 Duty Factor (10 mA Avg.)	1150	2800		μcd
			1400	3500		
Luminous Intensity/Dot <sup>[4]</sup> (Digit Average) HDSP-L20X HDSP-450X	I <sub>V</sub>	30 mA pk: 1 of 14 Duty Factor (2.1 mA Avg.)		740		μcd
				930		
Peak Wavelength	λ <sub>PEAK</sub>			635		nm
Dominant Wavelength <sup>[5]</sup>	λ <sub>d</sub>			626		nm
Forward Voltage	V <sub>F</sub>	I <sub>F</sub> = 50 mA		2.6	3.5	V
Reverse Voltage <sup>[6]</sup>	V <sub>R</sub>	I <sub>R</sub> = 100 μA	3.0	25.0		V
Temperature Coefficient of V <sub>F</sub>	ΔV <sub>F</sub> /°C			-2.0		mV/°C
Thermal Resistance LED Junction-to-Pin per package HDSP-L20X HDSP-450X	Rθ <sub>J-PIN</sub>			15		°C/W/ PACK
				13		

### High Performance Green HDSP-540X/510X Series

Description	Symbol	Test Conditions	Min.	Typ.	Max.	Units
Luminous Intensity/Dot <sup>[4]</sup> (Digit Average) HDSP-540X (17.3 mm) HDSP-510X (26.5 mm)	I <sub>V</sub>	50 mA pk: 1 of 5 Duty Factor (10 mA Avg.)	1290	4000		μcd
			1540	4500		
Luminous Intensity/Dot <sup>[4]</sup> (Digit Average) HDSP-540X HDSP-510X	I <sub>V</sub>	30 mA pk: 1 of 14 Duty Factor (2.1 mA Avg.)		570		μcd
				630		
Peak Wavelength	λ <sub>PEAK</sub>			566		nm
Dominant Wavelength <sup>[5,7]</sup>	λ <sub>d</sub>			571		nm
Forward Voltage	V <sub>F</sub>	I <sub>F</sub> = 50 mA		2.6	3.5	V
Reverse Voltage <sup>[6]</sup>	V <sub>R</sub>	I <sub>R</sub> = 100 μA	3.0	25.0		V
Temperature Coefficient of V <sub>F</sub>	ΔV <sub>F</sub> /°C			-2.0		mV/°C
Thermal Resistance LED Junction-to-Pin per package HDSP-540X HDSP-510X	Rθ <sub>J-PIN</sub>			15		°C/W/ PACK
				13		

**Notes:**

- The displays are categorized for luminous intensity with the intensity category designated by a letter on the left hand side of the package. The luminous intensity minimum and categories are determined by computing the numerical average of the individual dot intensities.
- The dominant wavelength is derived from the C.I.E. Chromaticity diagram and is that single wavelength which defines the color of the device.
- Typical specification for reference only. Do not exceed absolute maximum ratings.
- The displays are categorized for dominant wavelength with the category designated by a number adjacent to the intensity category letter.



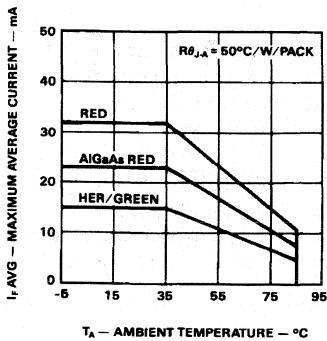

Figure 1. Maximum Allowable Average Current Per Dot as a Function of Ambient Temperature.

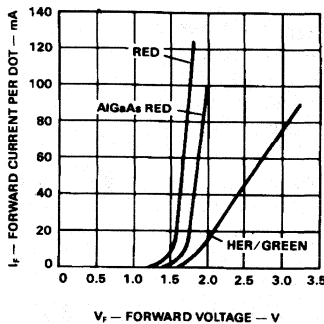

Figure 2. Forward Current vs. Forward Voltage.

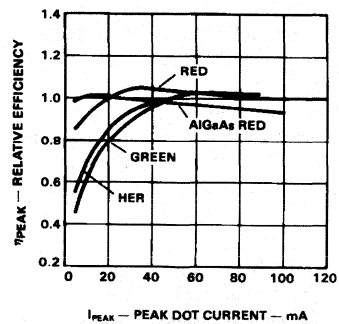

Figure 3. Relative Efficiency (Luminous Intensity per Unit Dot) vs. Peak Current per Dot.

## Operational Considerations

### Electrical Description

These display devices are composed of light emitting diodes, with the light from each LED optically stretched to form individual dots.

These display devices are well suited for strobed operation. The typical forward voltage values can be scaled from Figure 2. These values should be used to calculate the current limiting resistor value and the typical power dissipation. Expected maximum  $V_F$  values, for driver circuit design and maximum power dissipation, may be calculated using the following  $V_{FMAX}$  models:

Red (HDSP-440X/470X):

$$V_{FMAX} = 1.55 \text{ V} + I_{PEAK}(6.5 \Omega)$$

For  $I_{PEAK} \geq 5 \text{ mA}$

AlGaAs Red

(HDSP-L10X/M10X):

$$V_{FMAX} = 1.8 \text{ V} + I_{PEAK}(20 \Omega)$$

For  $I_{PEAK} \leq 20 \text{ mA}$

$$V_{FMAX} = 2.0 \text{ V} + I_{PEAK}(10 \Omega)$$

For  $I_{PEAK} \geq 20 \text{ mA}$

HER (HDSP-450X/L20X):

$$V_{FMAX} = 1.75 \text{ V} + I_{PEAK}(35 \Omega)$$

For  $I_{PEAK} \geq 5 \text{ mA}$

Green (HDSP-540X/510X):

$$V_{FMAX} = 1.75 \text{ V} + I_{PEAK}(38 \Omega)$$

For  $I_{PEAK} \geq 5 \text{ mA}$

Figure 3 allows the designer to calculate the luminous intensity at different peak and average currents. The following equation calculates intensity at different peak and average currents:

$$I_VAVG = (I_{FAVG}/I_{FAVG \text{ DATA SHEET}})(\eta_{PEAK})(I_V \text{ DATA SHEET})$$

Where:

$I_{FAVG}$  is the desired time averaged LED current.

$I_{FAVG \text{ DATA SHEET}}$  is the time averaged data sheet test current for  $I_V \text{ DATA SHEET}$ .

$\eta_{PEAK}$  is the relative efficiency at the peak current, scaled from Figure 3.

$I_V \text{ DATA SHEET}$  is the time averaged data sheet luminous intensity, resulting from  $I_{FAVG \text{ DATA SHEET}}$ .

$I_VAVG$  is the calculated time averaged luminous intensity resulting from  $I_{FAVG}$ .

For example, what is the luminous intensity of an AlGaAs Red (HDSP-L10X) driven at 50 mA peak 1/5 duty factor?

$$I_{FAVG} = 50 \text{ mA} * 0.2 = 10 \text{ mA}$$

$$I_{FAVG \text{ DATA SHEET}} = 2 \text{ mA}$$

$$\eta_{PEAK} = 0.98$$

$$I_V \text{ DATA SHEET} = 1650 \mu\text{cd}$$

Therefore

$$I_VAVG = (10 \text{ mA}/2 \text{ mA})(0.98)(1650 \mu\text{cd}) = 8085 \mu\text{cd}$$

## Thermal Considerations

The device thermal resistance may be used to calculate the junction temperature of the central LED. The equation below calculates the junction temperature of the central (hottest) LED.

$$\begin{aligned}T_J &= T_A + (P_D)(R_{\theta_{J-A}})(N) \\P_D &= (V_{FMAX})(I_{FAVG}) \\R_{\theta_{J-A}} &= R_{\theta_{J-PIN}} + R_{\theta_{PIN-A}}\end{aligned}$$

$T_J$  is the junction temperature of the central LED.

$T_A$  is the ambient temperature.

$P_D$  is the power dissipated by one LED.

$N$  is the number of LEDs ON per character.

$V_{FMAX}$  is calculated using the appropriate  $V_F$  model.

$R_{\theta_{J-A}}$  is the package thermal resistance from the central LED to the ambient.

$R_{\theta_{J-PIN}}$  is the package thermal resistance from the central LED to pin.

$R_{\theta_{PIN-A}}$  is the package thermal resistance from the pin to the ambient.

For example, what is the maximum ambient temperature an HDSP-L10X can operate with the following conditions:

$$\begin{aligned}I_{PEAK} &= 125 \text{ mA} \\I_{FAVG} &= 10 \text{ mA} \\R_{\theta_{J-A}} &= 50^\circ\text{C/W} \\N &= 35 \\T_{JMAX} &= 110^\circ\text{C}\end{aligned}$$

$$\begin{aligned}V_{FMAX} &= 2.0 \text{ V} + (0.125 \text{ A})(10) \\&= 3.25 \text{ V}\end{aligned}$$

$$\begin{aligned}P_D &= (3.25 \text{ V})(0.01 \text{ A}) \\&= 0.0325 \text{ W}\end{aligned}$$

$$\begin{aligned}T_A &= 110^\circ\text{C} - \\&\quad (50^\circ\text{C/W})(0.0325 \text{ W})(35) \\&= 53^\circ\text{C}\end{aligned}$$

The maximum number of dots ON for the ASCII character set is 20. What is the maximum ambient temperature an HDSP-L10X can operate with the following conditions:

$$\begin{aligned}I_{PEAK} &= 125 \text{ mA} \\I_{FAVG} &= 10 \text{ mA} \\R_{\theta_{J-A}} &= 50^\circ\text{C/W} \\N &= 20 \\T_{JMAX} &= 110^\circ\text{C}\end{aligned}$$

$$\begin{aligned}V_{FMAX} &= 3.25 \text{ V} \\P_D &= 0.0325 \text{ W} \\T_A &= 110^\circ\text{C} - \\&\quad (50^\circ\text{C/W})(0.0325 \text{ W})(20) \\&= 77^\circ\text{C}\end{aligned}$$

Therefore, the maximum ambient temperature can be increased by reducing the average number of dots ON from 35 to 20 dots ON per display.

## Contrast Enhancement

For information on contrast enhancement please see Application Note 1015.

## Soldering/Cleaning

For Soldering/Cleaning information on soldering LEDs please refer to Application Note 1027.

# LED Glass/Ceramic Displays

---

## LED Glass/Ceramic Displays



In addition to commercial solid state displays, Hewlett-Packard offers a selection of environmentally sealed glass/ceramic packages for industrial and high reliability applications. These packages consist of numeric and hexadecimal displays, 5 x 7 dot matrix alphanumeric displays with extended temperature ranges, and fully intelligent monolithic 16 segment displays

with extended temperature ranges and on board CMOS ICs. Similar to the commercial display product selection, the glass/ceramic display products are offered in a variety of character sizes and colors: standard red, high efficiency red, yellow, and high performance green. Orange displays are sometimes available upon request.

---

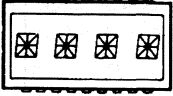

Integrated numeric and hexadecimal displays (with on-board ICs) solve the designer's decoding/driving problems. They are available in plastic packages for general purpose usage and glass/ceramic packages for industrial applications. This family of displays has been designed for ease of use in a wide range of environments.

## Glass/Ceramic Alphanumeric Displays

Device	P/N	Description	Color	Application	Page No.
	HDSP-2131	5.0 mm (0.20 in.) 5 x 7 Eight Character Smart Alphanumeric Display	Yellow	<ul style="list-style-type: none"> <li>• High Reliability Applications</li> <li>• Avionics</li> <li>• I/O Terminals</li> <li>• Industrial Equipment</li> </ul>	3-224
	HDSP-2132		High Efficiency Red		
	HDSP-2133	32 pin Ceramic 7.62 mm (0.3 in.) DIP with Untinted Glass Lens	High Performance Green		
	HDSP-2179	Operating Temperature Range: -55°C to +85°C	Orange		
	HMDL-2416	4.1 mm (0.16 in.) Four Character Monolithic Smart Alphanumeric Display  CMOS IC  32 pin Ceramic 15.24 mm (0.6 in.) DIP with Untinted Glass Lens  Operating Temperature Range: -55°C to +100°C	Standard Red		*
	HCMS-2351	5.0 mm (0.20 in.) 5 x 7 Four Character Alphanumeric Sunlight Viewable Display	Yellow		3-240
	HCMS-2352		High Efficiency Red		
	HCMS-2353	CMOS IC	High Performance Green		
	HCMS-2354	12 pin Ceramic 6.35 mm (0.25 in.) DIP with Untinted Glass Lens  Operating Temperature Range: -55°C to +100°C	Orange		



\*Contact your local Hewlett-Packard sales representative for information regarding this product.

### Glass/Ceramic Alphanumeric Displays (Cont.)

Device	P/N	Description	Color	Application	Page No.
	HCMS-2010	3.7 mm (0.15 in.) 5 x 7 Four Character Alphanumeric	Standard Red, Red Glass Contrast Filter	<ul style="list-style-type: none"> <li>• Extended Temperature Applications Requiring High Reliability</li> <li>• I/O Terminals</li> <li>• Avionics</li> </ul>	3-240
	HCMS-2011	CMOS IC	Yellow		
	HCMS-2012	12-pin Ceramic 7.62 mm (0.3 in.) DIP with Glass Lens	High Efficiency Red		
	HCMS-2013	Operating Temperature Range: -55°C to +100°C	High Performance Green		
	HCMS-2310	5.0 mm (0.20 in.) 5 x 7 Four Character Alphanumeric	Standard Red		
	HCMS-2311		Yellow		
	HCMS-2312	CMOS IC	High Efficiency Red		
	HCMS-2313	12 Pin Ceramic 6.35 mm (0.25 in.) DIP with untinted glass lens	High Performance Green		
	HCMS-2314	Operating Temperature Range: -55°C to +100°C	Orange		
	HDSP-2351	4.87 mm (0.19 in.) 5 x 7 Four Character Alphanumeric Sunlight Viewable Display	Yellow		*
	HDSP-2352		High Efficiency Red		
	HDSP-2353	12 pin Ceramic 6.35 mm (0.25 in.) DIP with Untinted Glass Lens	High Performance Green		
		Operating Temperature Range: -55°C to +100°C			

\*Contact your local Hewlett-Packard sales representative for information regarding this product.

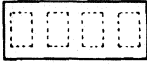

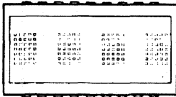
**Glass/Ceramic Alphanumeric Displays (Cont.)**

Device	P/N	Description	Color	Application	Page No.
	HDSP-2010	3.7 mm (0.15 in.) 5 x 7 Four Character Alphanumeric  12 pin 7.62 mm (0.3 in.) Ceramic DIP with Red Glass Lens  Operating Temperature Range: -40°C to +85°C	Standard Red, Red Glass Contrast Filter	<ul style="list-style-type: none"> <li>• Extended Temperature Applications Requiring High Reliability</li> <li>• I/O Terminals</li> <li>• Avionics</li> <li>• Ground Support, Shipboard Systems</li> </ul>	*
	HDSP-2310	5.0 mm (0.20 in.) 5 x 7 Four Character Alphanumeric	Standard Red	For further information see Application Note 1016.	*
	HDSP-2311	12 Pin Ceramic 6.35 mm (0.25 in.) DIP with Untinted Glass Lens	Yellow		
	HDSP-2312		High Efficiency Red		
	HDSP-2313	Operating Temperature Range: -55°C to +85°C	High Performance Green		
	HDSP-2450	6.9 mm (0.27 in.) 5 x 7 Four Character Alphanumeric	Standard Red		*
	HDSP-2451	28 Pin Ceramic 15.24 mm (0.6 in.) DIP with Untinted Glass Lens	Yellow		
	HDSP-2452		High Efficiency Red		
	HDSP-2453	Operating Temperature Range: -55°C to +85°C	High Performance Green		
	HDSP-6650	5.0 mm (0.20 in.) 5 x 7 Four Character Dot Matrix	Orange		3-213
	HDSP-6651	Fully Intelligent Display	Yellow		
	HDSP-6652	18 pin Ceramic 15.24 mm (0.6 in.) DIP with Untinted Glass Lens	High Efficiency Red		
	HDSP-6653	Operating Temperature Range: -55°C to +85°C	Green		

GLASS/CERAMIC DISPLAYS

\*Contact your local Hewlett-Packard sales representative for information regarding this product.

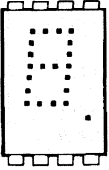
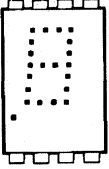
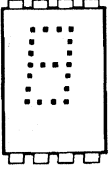
### Glass/Ceramic Hexadecimal and Numeric Dot Matrix Displays

Device	P/N	Description	Package	Applications	Page No.
 (A)	4N51 (A)	Numeric RHDP Decoder/Driver/Memory	8 Pin Hermetic Built-in 15.2 mm (0.6 in.) DIP with Gold Plated Leads	<ul style="list-style-type: none"> <li>• High Reliability Applications</li> <li>• Avionics</li> <li>• Fire Control Systems</li> <li>• Ground Support, Shipboard Equipment</li> </ul>	3-249
	4N52 (B)	Numeric LHDP Built-in Decoder/Driver/Memory			
	4N54 (C)	Hexadecimal Built-in Decoder/Driver/Memory			
	4N53 (D)	Character Plus/Minus Sign			
 (B)	HDSP-0781 (A)	Numeric RHDP, Built-in Decoder/Driver Memory	High Efficiency Red Low Power		3-256
	HDSP-0782 (B)	Numeric LHDP, Built-in Decoder/Driver Memory			
	HDSP-0783 (D)	Ovrange $\pm 1$			
	HDSP-0784 (C)	Hexadecimal, Built-in Decoder/Driver Memory			
 (C)	HDSP-0791 (A)	Numeric RHDP, Built-in Decoder/Driver Memory	High Efficiency Red High Brightness	<ul style="list-style-type: none"> <li>• Ground, Airborne, Shipboard Equipment</li> <li>• Fire Control Systems</li> <li>• Industrial</li> </ul>	
	HDSP-0792 (B)	Numeric LHDP, Built-in Decoder/Driver Memory			
	HDSP-0793 (D)	Ovrange $\pm 1$			
	HDSP-0794 (C)	Hexadecimal, Built-in Decoder/Driver Memory			
 (D)	HDSP-0881 (A)	Numeric RHDP, Built-in Decoder/Driver Memory	Yellow		
	HDSP-0882 (B)	Numeric LHDP, Built-in Decoder/Driver Memory			
	HDSP-0883 (D)	Ovrange $\pm 1$			
	HDSP-0884 (C)	Hexadecimal, Built-in Decoder/Driver Memory			
7.4 mm (0.29 in.) 4 x 7 Single Digit Package 8 Pin Glass/Ceramic 15.2 mm (0.6 in.) DIP	HDSP-0981 (A)	Numeric RHDP, Built-in Decoder/Driver Memory	High Performance Green	<ul style="list-style-type: none"> <li>• Ground, Airborne, Shipboard Equipment</li> <li>• Fire Control Systems</li> <li>• Industrial</li> </ul>	
	HDSP-0982 (B)	Numeric LHDP, Built-in Decoder/Driver Memory			
	HDSP-0983 (C)	Ovrange $\pm 1$			
	HDSP-0984 (D)	Hexadecimal, Built-in Decoder/Driver Memory			



# Four Character 5 mm Glass/ Ceramic 5 x 7 Alphanumeric Displays for Avionic Applications

## Technical Data

### HDSP-665X Series

#### Features

- Readable in 8000 fc Daylight with Filter
- Wide 60° Viewing Angle
- Glass/Ceramic Package
- Operating Temperature Range: -55°C to +85°C
- On-Board CMOS IC
- Data RAM, Decoder, LED Drive Circuitry
- 128 ASCII Character Set
- Dimming and Blanking

#### Description

These devices are hermetic, 5.0 mm (0.20 in.) high, four character, 5 x 7 dot matrix alphanumeric LED displays designed specifically for use in avionic systems, both commercial and military. These displays are also ideal for use in other non-avionic high reliability and military applications. When used with the proper contrast enhancement filter, these displays are readable in an 8000 fc daylight ambient. Each display has an on-board CMOS IC that decodes and stores 7 bit ASCII data and drives the LED matrix within each charac-

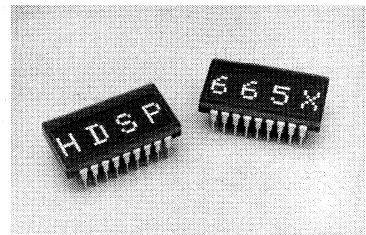

GLASS/CERAMIC  
DISPLAYS

ter. The IC may be interfaced to a microprocessor by connecting the inputs directly to the microprocessor address and data buses. Display blanking and eight levels of dimming are software controlled.

#### Device Selection Guide

Yellow	High Efficiency Red	High Performance Green	Orange
HDSP-6651	HDSP-6652	HDSP-6653	HDSP-6650

**ESD WARNING: NORMAL CMOS HANDLING PRECAUTIONS SHOULD BE OBSERVED TO AVOID STATIC DISCHARGE.**

## Absolute Maximum Ratings

Supply Voltage, $V_{DD}$ to Ground <sup>[1]</sup> .....	-0.5 V to 7.0 V
Input Voltage, Any Pin to Ground.....	-0.5 to $V_{DD} + 0.5$ V
Free Air Operating Temperature Range, $T_A$ .....	-55°C to +85°C
Storage Temperature Range, $T_S$ .....	-55°C to +100°C
CMOS IC Junction Temperature, $T_J$ (IC).....	+150°C
ESD Protection, $R = 1.5$ k $\Omega$ , $C = 100$ pF.....	$V_Z = 4$ kV (each pin)
Maximum Solder Temperature at Lead Seating Plane, $t < 5$ sec. ....	260°C

### Note:

1. Maximum voltage is with no LEDs illuminated.

## Package Dimensions

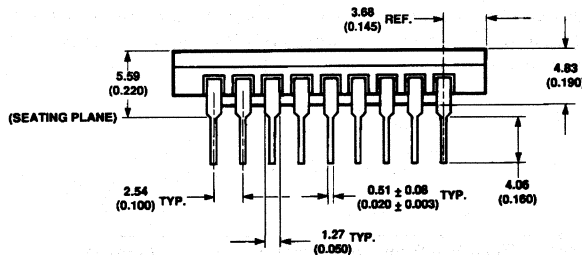
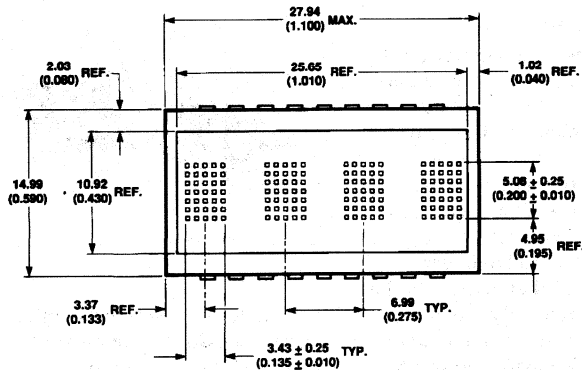

HDSP-665X

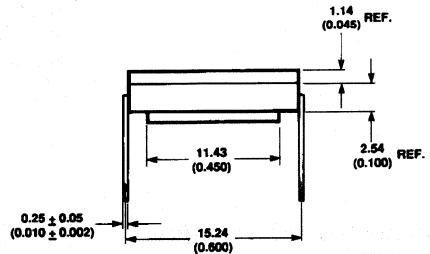
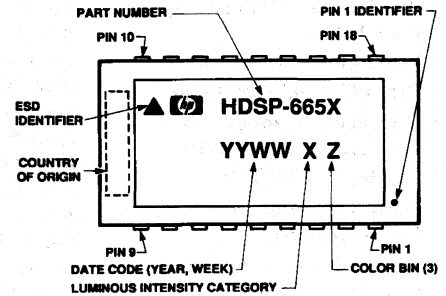

### Notes:

1. All dimensions are in mm (inches).
2. Unless otherwise specified, tolerance on dimensions is  $\pm 0.38$  mm ( $\pm 0.015$  in.).
3. For yellow and green devices only.
4. Leads are Alloy 42, solder dipped.

Pin No.	Function	Pin No.	Function
1	$\overline{CE}_1$ Chip Enable	10	GND
2	$\overline{CE}_2$ Chip Enable	11	$D_0$ Data Input
3	$\overline{CLR}$ Clear	12	$D_1$ Data Input
4	$\overline{CUE}$ Cursor Enable	13	$D_2$ Data Input
5	$\overline{CU}$ Cursor Select	14	$D_3$ Data Input
6	$\overline{WR}$ Write	15	$D_6$ Data Input
7	$A_1$ Address Input	16	$D_5$ Data Input
8	$A_0$ Address Input	17	$D_4$ Data Input
9	$V_{DD}$	18	$\overline{BL}$ Display Blank

# Character Set

ASCII CODE				D0	0	1	0	1	0	1	0	1	0	1	0	1	0	1		
				D1	0	0	1	1	0	0	1	1	0	0	1	1	0	0	1	1
				D2	0	0	0	0	1	1	1	1	0	0	0	0	1	1	1	1
				D3	0	0	0	0	0	0	0	0	1	1	1	1	1	1	1	1
D6	D5	D4	Hex	0	1	2	3	4	5	6	7	8	9	A	B	C	D	E	F	
0	0	0	0																	
0	0	1	1																	
0	1	0	2																	
0	1	1	3																	
1	0	0	4																	
1	0	1	5																	
1	1	0	6																	
1	1	1	7																	

**Notes:**

- 1. High = 1 level.
- 2. Low = 0 level.

GLASS/CERAMIC DISPLAYS

## Recommended Operating Conditions

Parameter	Symbol	Min.	Typ.	Max.	Unit
Supply Voltage	$V_{DD}$	4.5	5.0	5.5	V

## Electrical Characteristics over Operating Temperature Range

4.5 <  $V_{DD}$  < 5.5 V (unless otherwise specified)

### All Devices

Parameter	Symbol	Min.	25°C <sup>[1]</sup>		Max.	Units	Test Conditions
			Typ.	Max.			
$I_{DD}$ Blank	$I_{DD}$ (blk)		1.0		4.0	mA	All Digits Blanked
Input Current	$I_I$	-40			10	μA	$V_{IN} = 0$ V to $V_{DD}$ $V_{DD} = 5.0$ V
Input Voltage High	$V_{IH}$	2.0			$V_{DD}$	V	
Input Voltage Low	$V_{IL}$	GND			0.8	V	
$I_{DD}$ 4 digits 20 dots/character <sup>[2,3]</sup>	$I_{DD}$ (#)		110	130	160	mA	"#" ON in all four locations
$I_{DD}$ Cursor all dots ON @ 50%	$I_{DD}$ (CU)		92	110	135	mA	Cursor ON in all four locations
Thermal Resistance IC Junction to Pin	$R\theta_{J-PIN}$		11			°C/W	IC Junction to GND Pin 10.

### Notes:

- $V_{DD} = 5.0$  V.
- Average  $I_{DD}$  measured at full brightness. Peak  $I_{DD} = 28/15 \times$  Average  $I_{DD}(\#)$ .
- $I_{DD}(\#)$  max. = 130 mA at full brightness, 150°C IC junction temperature and  $V_{DD} = 5.5$  V.

## Optical Characteristics at 25°C<sup>[1]</sup>

V<sub>DD</sub> = 5.0 V at Full Brightness

### HDSP-6651 Yellow

Parameter	Symbol	Min.	Typ.	Units	Test Conditions
Average Luminous Intensity per digit, Character Average	I <sub>V</sub>	3.9	5.0	mcd	"*" illuminated in all four digits. 19 dots ON
Peak Wavelength	λ <sub>PEAK</sub>		583	nm	
Dominant Wavelength <sup>[2]</sup>	λ <sub>d</sub>		585	nm	

### HDSP-6652 High Efficiency Red

Parameter	Symbol	Min.	Typ.	Units	Test Conditions
Average Luminous Intensity per digit, Character Average	I <sub>V</sub>	3.9	5.0	mcd	"*" illuminated in all four digits. 19 dots ON
Peak Wavelength	λ <sub>PEAK</sub>		635	nm	
Dominant Wavelength <sup>[2]</sup>	λ <sub>d</sub>		626	nm	

### HDSP-6653 Green

Parameter	Symbol	Min.	Typ.	Units	Test Conditions
Average Luminous Intensity per digit, Character Average	I <sub>V</sub>	5.55	7.40	mcd	"*" illuminated in all four digits. 19 dots ON
Peak Wavelength	λ <sub>PEAK</sub>		568	nm	
Dominant Wavelength <sup>[2]</sup>	λ <sub>d</sub>		572	nm	

### HDSP-6650 Orange

Parameter	Symbol	Min.	Typ.	Units	Test Conditions
Average Luminous Intensity per digit, Character Average	I <sub>V</sub>	3.9	5.0	mcd	"*" illuminated in all four digits. 19 dots ON
Peak Wavelength	λ <sub>PEAK</sub>		600	nm	
Dominant Wavelength <sup>[2]</sup>	λ <sub>d</sub>		602	nm	

#### Notes:

1. Refers to the initial case temperature of the device immediately prior to the light measurement.
2. Dominant wavelength, λ<sub>d</sub>, is derived from the CIE chromaticity diagram, and represents the single wavelength which defines the color of the device.

**AC Timing Characteristics over Operating Temperature Range at  $V_{DD} = 4.5\text{ V}$**

Parameter	Symbol	Min.	Units
Address Setup	$t_{AS}$	10	ns
Address Hold	$t_{AH}$	40	ns
Data Setup	$t_{DS}$	50	ns
Data Hold	$t_{DH}$	40	ns
Chip Enable Setup	$t_{CES}$	0	ns
Chip Enable Hold	$t_{CEH}$	0	ns
Write Time	$t_W$	75	ns
Clear	$t_{CLR}$	10	$\mu\text{s}$
Clear Disable	$t_{CLRD}$	1	$\mu\text{s}$

**Timing Diagram**

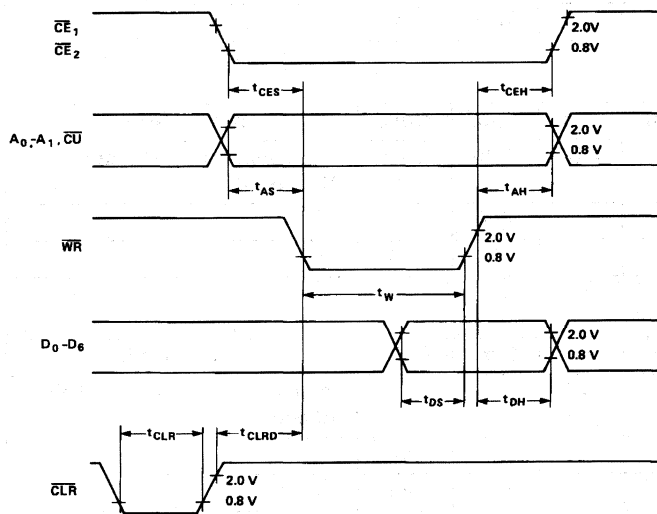

## Electrical Description

Pin Function	Description
Chip Enable ( $\overline{CE}_1$ and $\overline{CE}_2$ , pins 1 and 2)	$\overline{CE}_1$ and $\overline{CE}_2$ must be a logic 0 to write to the display.
Clear ( $\overline{CLR}$ , pin 3)	When $\overline{CLR}$ is a logic 0 the ASCII RAM is reset to 20hex (space) and the Control Register/Attribute RAM is reset to 00hex.
Cursor Enable (CUE pin 4)	CUE determines whether the IC displays the ASCII or the Cursor memory. (1 = Cursor, 0 = ASCII).
Cursor Select ( $\overline{CU}$ , pin 5)	$\overline{CU}$ determines whether data is stored in the ASCII RAM or the Attribute RAM/Control Register. (1 = ASCII, 0 = Attribute RAM/Control Register).
Write ( $\overline{WR}$ , pin 6)	$\overline{WR}$ must be a logic 0 to store data in the display.
Address Inputs ( $A_1$ and $A_0$ , pins 8 and 7)	$A_0$ - $A_1$ selects a specific location in the display memory. Address 00 accesses the far right display location. Address 11 accesses the far left location.
Data Inputs ( $D_0$ - $D_6$ , pins 11-17)	$D_0$ - $D_6$ are used to specify the input data for the display.
$V_{DD}$ (pin 9)	$V_{DD}$ is the positive power supply input.
GND (pin 10)	GND is the display ground.
Blanking Input ( $\overline{BL}$ , pin 18)	$\overline{BL}$ is used to flash the display, blank the display or to dim the display.

## Display Internal Block Diagram

Figure 1 shows the HDSP-665X display internal block diagram. The CMOS IC consists of a 4 x 7 Character RAM, a 2 x 4 Attribute RAM, a 5 bit Control Register, a 128 character ASCII decoder and the refresh circuitry necessary to synchronize the decoding and driving of four 5 x 7 dot matrix characters.

Four 7 bit ASCII words are stored in the Character RAM. The IC reads the ASCII data and decodes it via the 128 character ASCII decoder.

A 5 bit word is stored in the Control Register. Three fields within the Control Register provide an 8 level brightness control, master blank, and extended functions disable.

For each display digit location, two bits are stored in the Attribute RAM. One bit is used to enable a cursor character at each digit location. A second bit is used to individually disable the blanking features at each digit location.

The display is blanked and dimmed through an internal blanking input on the row drivers. Logic within the IC allows the user to dim the display either through the  $\overline{BL}$  input or through the brightness control in the control register. Similarly, the display can be blanked through the  $\overline{BL}$  input, the Master Blank in the Control Register, or the Digit Blank Disable in the Attribute RAM.

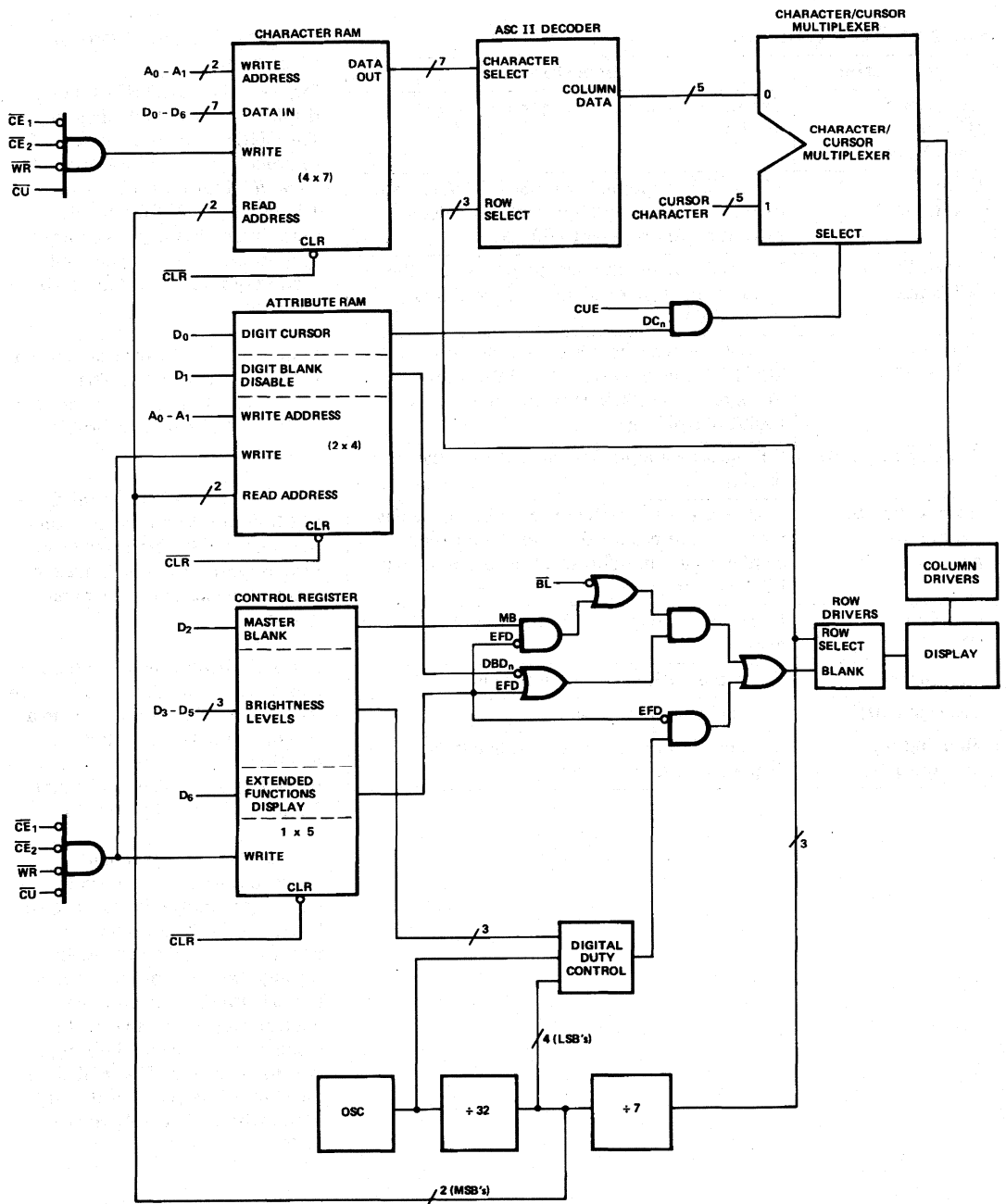

Figure 1. Internal Block Diagram



## Display Clear

Data stored in the Character RAM, Control Register, and Attribute RAM will be cleared if the clear ( $\overline{\text{CLR}}$ ) is held low for a minimum of 10  $\mu\text{s}$ . Note that the display will be cleared regardless of the state of the chip enables ( $\overline{\text{CE}}_1$ ,  $\overline{\text{CE}}_2$ ). After the display is cleared, the ASCII code for a space (20H) is loaded into all character RAM locations and 00H is loaded into all Attribute RAM/Control Register memory locations.

## Data Entry

Figure 2 shows the truth table for the HDSP-665X displays. Setting the chip enables ( $\overline{\text{CE}}_1$ ,  $\overline{\text{CE}}_2$ ) to logic 0 and the cursor select ( $\overline{\text{CU}}$ ) to logic 1 will enable ASCII data loading. When cursor select ( $\overline{\text{CU}}$ )

is set to logic 0, data will be loaded into the Control Register and Attribute RAM. Address inputs  $A_0$ - $A_1$  are used to select the digit location in the display. Data inputs  $D_0$ - $D_6$  are used to load information into the display. Data will be latched into the display on the rising edge of the  $\overline{\text{WR}}$  signal.  $D_0$ - $D_6$ ,  $A_0$ - $A_1$ ,  $\overline{\text{CE}}_1$ ,  $\overline{\text{CE}}_2$ , and  $\overline{\text{CU}}$  must be held stable during the write cycle to ensure that correct data is stored into the display. Data can be loaded into the display in any order. Note that when  $A_0$  and  $A_1$  are logic 0, data is stored in the right most display location.

## Cursor

When cursor enable (CUE) is a logic 1, a cursor will be displayed in all digit locations where a logic

1 has been stored in the Digit Cursor memory in the Attribute RAM. The cursor consists of all 35 dots ON at half brightness. A flashing cursor can be displayed by pulsing CUE. When CUE is a logic 0, the ASCII data stored in the Character RAM will be displayed regardless of the Digit Cursor bits.

## Blanking

Blanking of the display is controlled through the BL input, the Control Register and Attribute RAM. The user can achieve a variety of functions by using these controls in different combinations, such as full hardware display blank, software blank, blanking of individual characters, and synchronized

CUE	BL	$\overline{\text{CLR}}$	$\overline{\text{CE}}_1$	$\overline{\text{CE}}_2$	$\overline{\text{WR}}$	$\overline{\text{CU}}$	$A_1$	$A_0$	$D_6$	$D_5$	$D_4$	$D_3$	$D_2$	$D_1$	$D_0$	Function
0	1	1														Display ASCII
1	1	1														Display Stored Cursor
X	X	0														Reset RAMs
X	0	1														Blank Display but do not reset RAMs and Control Register
X	X	1	0	0	0	0	0	0	0	Extended Functions Disable 0 = Enable $D_7$ - $D_5$ 1 = Disable $D_7$ - $D_5$ $D_0$ Always Enabled	Intensity Control 000 = 100% 001 = 60% 010 = 40% 011 = 27% 100 = 17% 101 = 10% 110 = 7% 111 = 3%	Master Blank 0 = Display ON 1 = Display Blanked	Digit Blank Disable 0	Digit Cursor 0	Write to Attribute RAM and Control Register  DBD <sub>n</sub> = 0, Allows Digit n to be blanked  DBD <sub>n</sub> = 1 Prevents Digit n from being blanked.  DC <sub>n</sub> = 0 Removes cursor from Digit n  DC <sub>n</sub> = 1 Stores cursor at Digit n	
							0	0	1				Digit Blank Disable 1	Digit Cursor 1		
							0	1	0				Digit Blank Disable 2	Digit Cursor 2		
							0	1	1				Digit Blank Disable 3	Digit Cursor 3		
X	X	1	0	0	0	0	1	0	0	Digit 0 ASCII Data (Right Most Character)						Write to Character RAM
							1	0	1	Digit 1 ASCII Data						
							1	1	0	Digit 2 ASCII Data						
							1	1	1	Digit 3 ASCII Data (Left Most Character)						
X	X	1	1	X	X	X	X	X	X	X	X	X	X	X	X	No Change
			X	1	X											
			X	X	1											

0 = Logic 0; 1 = Logic 1; X = Do Not Care.

Figure 2. Display Truth Table

flashing of individual characters or entire display (by strobing the blank input). All of these blanking modes affect only the output drivers, maintaining the contents and write capability of the internal RAMs and Control Register, so that normal loading of RAMs and Control Register can take place even with the display blanked.

Figure 3 shows how the Extended Function Disable (bit D<sub>6</sub> of the Control Register), Master Blank (bit D<sub>2</sub> of the Control Register), Digit Blank Disable (bit D<sub>1</sub> of the Attribute RAM), and  $\overline{BL}$  input can be used to blank the display.

When the Extended Function Disable is a logic 1, the display can be blanked only with the  $\overline{BL}$  input. When the Extended Function Disable is a logic 0, the display can be blanked through the BL input, the Master Blank, and the Digit Blank Disable. The entire display will be blanked if either the BL input is logic 0 or the Master Blank is logic 1, providing all Digit Blank Disable bits are logic 0. Those digits with Digit Blank Disable bits a logic 1 will ignore both blank signals and remain ON. The Digit Blank

EFD	MB	DBD <sub>n</sub>	$\overline{BL}$	
0	0	0	0	Display Blanked by $\overline{BL}$
0	0	X	1	Display ON
0	X	1	0	Display Blanked by $\overline{BL}$ . Individual characters "ON" based on "1" being stored in DBD <sub>n</sub>
0	1	0	X	Display Blanked by MB
0	1	1	1	Display Blanked by MB. Individual characters "ON" based on "1" being stored in DBD <sub>n</sub>
1	X	X	0	Display Blanked by $\overline{BL}$
1	X	X	1	Display ON

Figure 3. Display Blanking Truth Table

Disable bits allow individual characters to be blanked or flashed in synchronization with the BL input.

### Dimming

Dimming of the display is controlled through either the  $\overline{BL}$  input or the Control Register. A pulse width modulated signal can be applied to the  $\overline{BL}$  input to dim the display. A three bit word in the Control Register generates an internal pulse width modulated signal to dim the display. The internal dimming feature is

enabled only if the Extended Function Disable is a logic 0.

Bits 3-5 in the Control Register provide internal brightness control. These bits are interpreted as a three bit binary code, with code (000) corresponding to the maximum brightness and code (111) to the minimum brightness. In addition to varying the display brightness, bits 3-5 also vary the average value of I<sub>DD</sub>. I<sub>DD</sub> can be specified at any brightness level as shown in Table 1:

Table 1. Current Requirements at Different Brightness Levels

Symbol	D <sub>5</sub>	D <sub>4</sub>	D <sub>3</sub>	Brightness	25°C Typ.	25°C Max.	Max. over Temp.	Units
I <sub>DD</sub> (#)	0	0	0	100%	110	130	160	mA
	0	0	1	60%	66	79	98	mA
	0	1	0	40%	45	53	66	mA
	0	1	1	27%	30	37	46	mA
	1	0	0	17%	20	24	31	mA
	1	0	1	10%	12	15	20	mA
	1	1	0	7%	9	11	15	mA
	1	1	1	3%	4	6	9	mA

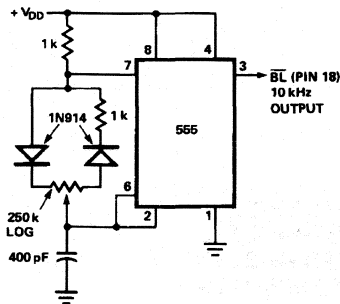

**Figure 4. Intensity Modulation Control Using an Astable Multivibrator (reprinted with permission from *Electronics* magazine, Sept. 19, 1974, VNU Business pub. Inc.)**

Figure 4 shows a circuit designed to dim the display from 98% to 2% by pulse width modulating the BL input. A logarithmic or a linear potentiometer may be used to adjust the display intensity. However, a logarithmic potentiometer matches the response of the human eye and therefore provides better resolution at low intensities. The circuit frequency should be designed to operate at 10 kHz or higher. Lower frequencies may cause the display to flicker.

### Mechanical and Electrical Considerations

These HDSP-665X series displays are 18 pin DIP class ceramic packages designed to meet the rugged reliability requirements of modern day avionic systems.

These displays may be stacked horizontally to form a character string of desired length. These displays are assembled by die attaching and wire bonding 140 LED dice and one CMOS IC to a ceramic substrate. A clear glass window is placed over the LEDs and sealed to form a hermetic air gap cavity. A similar window on the backside of the package forms a hermetic air gap cavity over the CMOS IC. Both windows permit post cap internal visual inspection of the LED dice and CMOS IC.

The inputs to the CMOS IC have protection against electrostatic discharge and input current latchup. However, for best results standard CMOS handling practice and precautions should be used. Prior to use, the HDSP-665X displays should be stored in anti-static or electrically conductive containers.

Input current latchup is caused when the CMOS inputs are subjected to either a voltage below ground ( $V_{in} < \text{ground}$ ), a higher voltage than  $V_{DD}$  ( $V_{in} > V_{DD}$ ), and when a high current is forced into the input. To prevent input current latchup and ESD damage, unused inputs should be connected to either ground or  $V_{DD}$ . Do not apply voltages to inputs until  $V_{DD}$  has been applied to the display.  $V_{DD}$  must be applied to the display prior to applying voltages to inputs in order to prevent latchup. Transient voltages should be eliminated from  $V_{DD}$  and data

lines. A 0.1  $\mu\text{F}$  capacitor placed between pin 9 ( $V_{DD}$ ) and pin 10 (GND) at each display will help eliminate extraneous noise from affecting the ICs. The impedance of the ground return line from pin 10 of each display to the power supply should be as close to zero as possible at a frequency of 200 Hz.

### ESD Susceptibility

These displays have an ESD susceptibility rating of CLASS 3 per MIL-HDBK-263A and CLASS 3 per MIL-STD-883C.

### Contrast Enhancement Filter Vendors

For information on contrast enhancement, see Application Note 1015, *Contrast Enhancement for LED Displays*.

### Soldering and Post Solder Cleaning

For information on soldering and post solder cleaning, see Application Note 1027 *Soldering LED Components*. These displays are fully compatible with semi-aqueous cleaning processes that use the terpene solvent BIOACT EC-7R.

### Night Vision Lighting

With the use of NVG/DV filters, the HDSP-6651/6653/6650 displays may be designed into NVG lighting applications. For further information, refer to Application Note 1030 *LED Displays and Indicators and Night Vision Imaging System Lighting*.

# Eight Character 5.0 mm (0.2 inch) Glass/Ceramic Smart 5 x 7 Alphanumeric Displays for Military Applications

## Technical Data

**HDSP-2131**  
**HDSP-2132**  
**HDSP-2133**  
**HDSP-2179**

### Features

- **Wide Operating Temperature Range** -55°C to +85°C
- **Smart Alphanumeric Display**  
On-Board CMOS IC  
Built-In RAM  
ASCII Decoder  
LED Drive Circuitry
- **128 ASCII Character Set**
- **16 User Definable Characters**
- **Programmable Features**  
Individual Character Flashing  
Full Display Blinking  
Multi-Level Dimming and Blanking  
Self Test  
Clear Function
- **Read/Write Capability**
- **Full TTL Compatibility**
- **HDSP-2131/-2133/-2179 Useable in Night Vision Lighting Applications**

- **Categorized for Luminous Intensity**
- **HDSP-2131/2133 Categorized for Color**
- **Excellent ESD Protection**
- **Wave Solderable**
- **X-Y Stackable**

### Description

The HDSP-2131 (yellow), HDSP-2179 (orange), HDSP-2132 (high efficiency red) and the HDSP-2133 (green) are eight-digit, 5 x 7 dot matrix, alphanumeric displays. The 5.0 mm (0.2 inch) high characters are packaged in a standard 7.64 mm (0.30 inch) 32 pin DIP. The on-board CMOS IC has the ability to decode 128 ASCII characters, which are permanently stored in ROM. In addition, 16 programmable symbols may be stored in an on-board RAM. Seven brightness

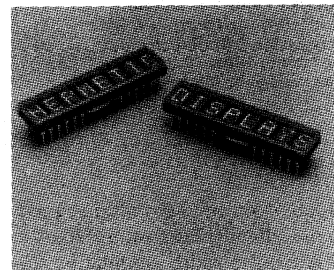

levels provide versatility in adjusting the display intensity and power consumption. The HDSP-213X is designed for standard microprocessor interface techniques. The display and special features are accessed through a bidirectional eight-bit data bus. These features make the HDSP-213X ideally suited for applications where a hermetic, low power alphanumeric display is required.

### Devices

Yellow	High Efficiency Red	High Performance Green	Orange
HDSP-2131	HDSP-2132	HDSP-2133	HDSP-2179

## Package Dimensions

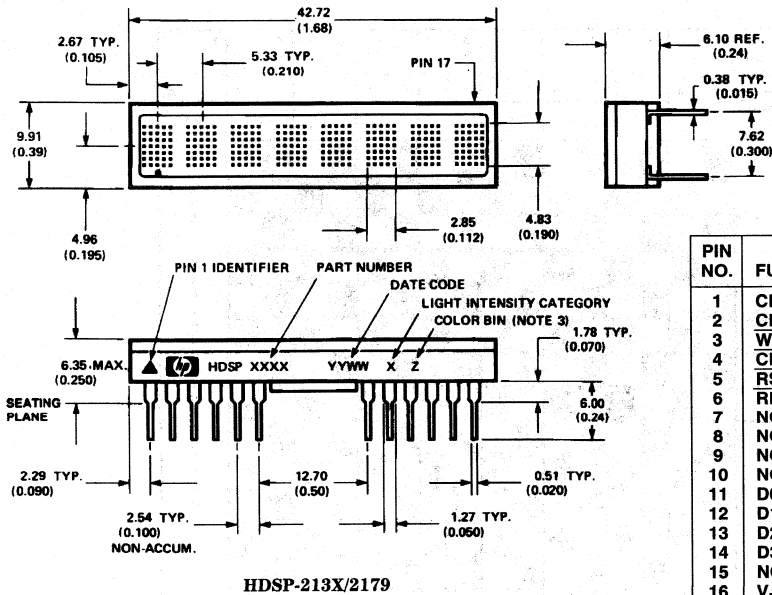

PIN NO.	FUNCTION	PIN NO.	FUNCTION
1	CLS	17	GND (SUPPLY)
2	CLK	18	GND (LOGIC)
3	WR	19	D4
4	CE	20	D5
5	RST	21	D6
6	RD	22	D7
7	NO PIN	23	NO PIN
8	NO PIN	24	NO PIN
9	NO PIN	25	NO PIN
10	NO PIN	26	NO PIN
11	D0	27	FL
12	D1	28	A0
13	D2	29	A1
14	D3	30	A2
15	NC	31	A3
16	V <sub>DD</sub>	32	A4

### Note:

1. All dimensions are in mm (inches).
2. Unless otherwise specified tolerance is  $\pm 0.30$  mm ( $\pm 0.015$ ).
3. For green and yellow devices only.
4. Leads are copper alloy, solder dipped.

### Absolute Maximum Ratings

Supply Voltage, V <sub>DD</sub> to Ground <sup>[1]</sup>	-0.3 to 7.0 V
Operating Voltage, V <sub>DD</sub> to Ground <sup>[2]</sup>	5.5 V
Input Voltage, Any Pin to Ground	-0.3 to V <sub>DD</sub> + 0.3 V
Free Air Operating Temperature Range, T <sub>A</sub>	-55°C to +85°C
Storage Temperature, T <sub>S</sub>	-55°C to +100°C
CMOS IC Junction Temperature, T <sub>J</sub> (IC)	+150°C
Maximum Solder Temperature	
at Seating Plane, t < 5 sec	260°C
ESD Protection @ 1.5 k $\Omega$ , 100 pF	V <sub>Z</sub> = 4 kV (each pin)

### Notes:

1. Maximum voltage is with no LEDs illuminated.
2. 20 dots ON in all locations at full brightness.

**ESD WARNING: STANDARD CMOS HANDLING PRECAUTIONS SHOULD BE OBSERVED WITH THE HDSP-2131, HDSP-2132, HDSP-2133, AND HDSP-2179.**

# Character Set

BITS		COLUMN								
D7	D6	D5	D4	D3	D2	D1	D0	ROW		
0	0	0	0	0	0	0	0	0	1	
0	0	0	0	1	0	1	0	1	X	
0	0	1	0	1	0	0	1	0	X	
0	1	0	1	0	1	1	1	1	X	
1	0	0	0	0	0	0	0	0		
1	0	0	0	0	0	0	0	1		
1	0	0	0	0	0	0	1	1		
1	0	0	0	0	0	1	0	1		
1	0	0	0	1	0	0	0	1		
1	0	0	1	0	1	1	1	1		
1	0	0	1	0	1	0	0	1		
1	0	1	0	1	0	0	0	1		
1	0	1	0	1	0	1	1	1		
1	1	0	0	0	0	0	0	0		
1	1	0	0	0	0	0	0	1		
1	1	0	0	0	0	1	0	1		
1	1	0	0	1	0	0	0	1		
1	1	0	0	1	0	1	1	1		
1	1	0	1	0	1	0	0	1		
1	1	0	1	0	1	1	1	1		
1	1	1	0	0	0	0	0	0		
1	1	1	0	0	0	0	0	1		
1	1	1	0	0	0	1	0	1		
1	1	1	0	0	1	0	0	1		
1	1	1	0	0	1	1	1	1		
1	1	1	1	0	0	0	0	0		
1	1	1	1	0	0	0	0	1		
1	1	1	1	0	0	1	0	1		
1	1	1	1	0	0	1	1	1		
1	1	1	1	1	0	0	0	0		
1	1	1	1	1	0	0	0	1		
1	1	1	1	1	0	1	0	1		
1	1	1	1	1	0	1	1	1		
1	1	1	1	1	1	0	0	0		
1	1	1	1	1	1	0	0	1		
1	1	1	1	1	1	1	0	1		
1	1	1	1	1	1	1	1	1		
0000	0									16 USER DEFINED CHARACTERS
0001	1									
0010	2									
0011	3									
0100	4									
0101	5									
0110	6									
0111	7									
1000	8									
1001	9									
1010	A									
1011	B									
1100	C									
1101	D									
1110	E									
1111	F									

**Recommended Operating Conditions**

Parameter	Symbol	Minimum	Nominal	Maximum	Units
Supply Voltage	$V_{DD}$	4.5	5.0	5.5	V

**Electrical Characteristics over Operating Temperature Range**4.5 <  $V_{DD}$  < 5.5 V (unless otherwise specified)

Parameter	Symbol	Min.	25°C Typ. <sup>[1]</sup>	25°C Max. <sup>[1]</sup>	Max. <sup>[2]</sup>	Units	Test Conditions
Input Leakage (Input without pullup)	$I_I$	-10.0			+10.0	$\mu$ A	$V_{IN} = 0$ to $V_{DD}$ , pins CLK, D <sub>0</sub> -D <sub>7</sub> , A <sub>0</sub> -A <sub>4</sub>
Input Current (Input with pullup)	$I_{IP}$	-30.0	11	18	30	$\mu$ A	$V_{IN} = 0$ to $V_{DD}$ , pins RST, CLS, WR, RD, CE, FL
$I_{DD}$ Blank	$I_{DD}$ (BLK)		0.5	1.5	2.0	mA	$V_{IN} = V_{DD}$
$I_{DD}$ 8 digits 12 dots/character <sup>[3]</sup>	$I_{DD}$ (V)		200	255	330	mA	"V" on in all 8 locations
$I_{DD}$ 8 digits 20 dots/character <sup>[3]</sup>	$I_{DD}$ (#)		300	370	430	mA	"#" on in all 8 locations
Input Voltage High	$V_{IH}$	2.0			$V_{DD}$ +0.3	V	$V_{DD} = 5.5$ V
Input Voltage Low	$V_{IL}$	GND -0.3 V			0.8	V	$V_{DD} = 4.5$ V
Output Voltage High	$V_{OH}$	2.4				V	$V_{DD} = 4.5$ V, $I_{OH} = -40$ $\mu$ A
Output Voltage Low D <sub>0</sub> -D <sub>7</sub>	$V_{OL}$				0.4	V	$V_{DD} = 4.5$ V, $I_{OL} = 1.6$ mA
Output Voltage Low CLK					0.4	V	$V_{DD} = 4.5$ V, $I_{OL} = 40$ $\mu$ A
Thermal Resistance IC Junction-to-PIN	$R\theta_{J-PIN}$		11			$^{\circ}$ C/W	

**Notes:**

- $V_{DD} = 5.0$  V.
- Maximum  $I_{DD}$  occurs at -55°C.
- Average  $I_{DD}$  measured at full brightness. See Table 2 in Control Word Section for  $I_{DD}$  at lower brightness levels. Peak  $I_{DD} = 28/15 \times$  Average  $I_{DD}$  (#).

### Optical Characteristics at 25°C<sup>[4]</sup>

V<sub>DD</sub> = 5.0 V at Full Brightness

#### High Efficiency Red HDSP-2132

Description	Symbol	Minimum	Typical	Units
Luminous Intensity Character Average (#)	I <sub>V</sub>	2.5	7.5	mcd
Peak Wavelength	λ <sub>PEAK</sub>		635	nm
Dominant Wavelength	λ <sub>d</sub>		626	nm

#### Orange HDSP-2179

Description	Symbol	Minimum	Typical	Units
Luminous Intensity Character Average (#)	I <sub>V</sub>	2.5	7.5	mcd
Peak Wavelength	λ <sub>PEAK</sub>		600	nm
Dominant Wavelength	λ <sub>d</sub>		602	nm

#### Yellow HDSP-2131

Description	Symbol	Minimum	Typical	Units
Luminous Intensity Character Average (#)	I <sub>V</sub>	2.5	7.5	mcd
Peak Wavelength	λ <sub>PEAK</sub>		583	nm
Dominant Wavelength	λ <sub>d</sub>		585	nm

#### High Performance Green HDSP-2133

Description	Symbol	Minimum	Typical	Units
Luminous Intensity Character Average (#)	I <sub>V</sub>	2.5	7.5	mcd
Peak Wavelength	λ <sub>PEAK</sub>		568	nm
Dominant Wavelength	λ <sub>d</sub>		574	nm

**Note:**

4. Refers to the initial case temperature of the device immediately prior to the light measurement.



## AC Timing Characteristics Over Temperature Range

$V_{DD} = 4.5$  to  $5.5$  V unless otherwise specified.

Reference Number	Symbol	Description	Min. <sup>[1]</sup>	Units
1	$t_{ACC}$	Display Access Time Write Read	210 230	ns
2	$t_{ACS}$	Address Setup Time to Chip Enable	10	ns
3	$t_{CE}$	Chip Enable Active Time <sup>[2, 3]</sup> Write Read	140 160	ns
4	$t_{ACH}$	Address Hold Time to Chip Enable	20	ns
5	$t_{CER}$	Chip Enable Recovery Time	60	ns
6	$t_{CES}$	Chip Enable Active Prior to Rising Edge of <sup>[1, 2]</sup> Write Read	140 160	ns
7	$t_{CEH}$	Chip Enable Hold Time to Rising Edge of Read/Write Signal <sup>[2, 3]</sup>	0	ns
8	$t_W$	Write Active Time <sup>[2, 3]</sup>	100	ns
9	$t_{WD}$	Data Valid Prior to Rising Edge of Write Signal	50	ns
10	$t_{DH}$	Data Write Hold Time	20	ns
11	$t_R$	Chip Enable Active Prior to Valid Data	160	ns
12	$t_{RD}$	Read Active Prior to Valid Data	75	ns
13	$t_{DF}$	Read Data Float Delay	10	ns
	$t_{RC}$	Reset Active Time <sup>[4]</sup>	300	ns

### Notes:

1. Worst case values occur at an IC junction temperature of 150°C.
2. For designers who do not need to read from the display, the Read line can be tied to  $V_{DD}$  and the Write and Chip Enable lines can be tied together.
3. Changing the logic levels of the Address lines when  $\overline{CE} = "0"$  may cause erroneous data to be entered into the Character RAM, regardless of the logic levels of the WR and RD lines.
4. The display must not be accessed until after 3 clock pulses (110  $\mu$ s min. using the internal refresh clock) after the rising edge of the reset line.

## AC Timing Characteristics Over Temperature Range

$V_{DD} = 4.5$  to  $5.5$  V unless otherwise specified.

Symbol	Description	25°C Typical	Minimum <sup>[1]</sup>	Units
$F_{OSC}$	Oscillator Frequency	57	28	kHz
$F_{RF}$ <sup>[5]</sup>	Display Refresh Rate	256	128	Hz
$F_{FL}$ <sup>[6]</sup>	Character Flash Rate	2	1	Hz
$t_{ST}$ <sup>[7]</sup>	Self Test Cycle Time	4.6	9.2	Sec

### Notes:

5.  $F_{RF} = F_{OSC}/224$ .

6.  $F_{FL} = F_{OSC}/28,672$ .

7.  $t_{ST} = 262,144/F_{OSC}$ .

## Write Cycle Timing Diagram

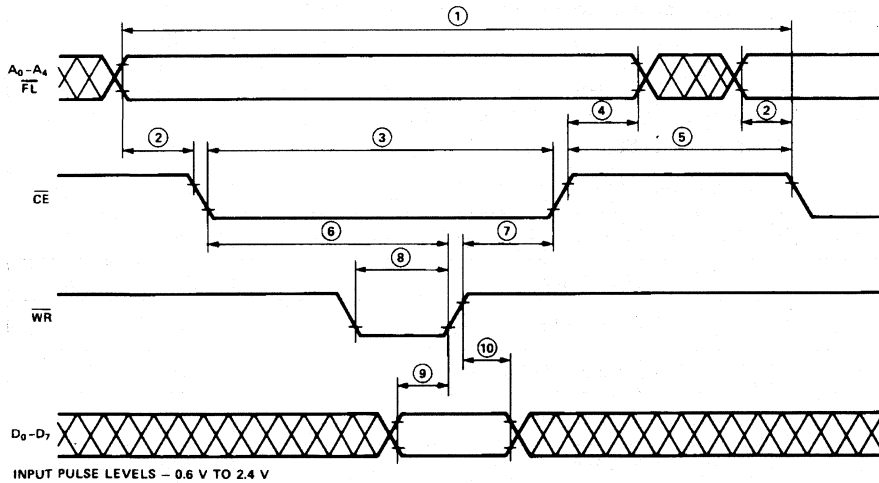

### Read Cycle Timing Diagram

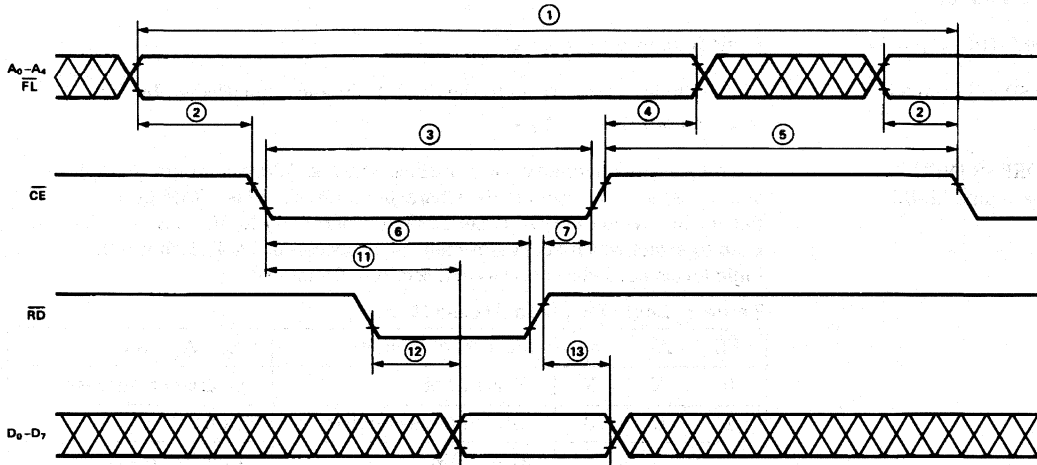

INPUT PULSE LEVELS: 0.6 V TO 2.4 V  
 OUTPUT REFERENCE LEVELS: 0.6 V TO 2.2 V  
 OUTPUT LOADING = 1 TTL LOAD AND 100pF

### Character Font

(Not to Scale)

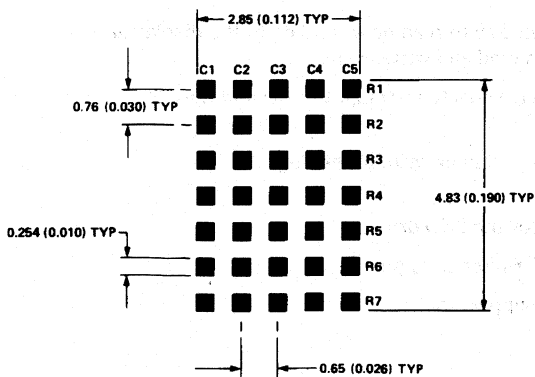

### Relative Luminous Intensity vs. Temperature

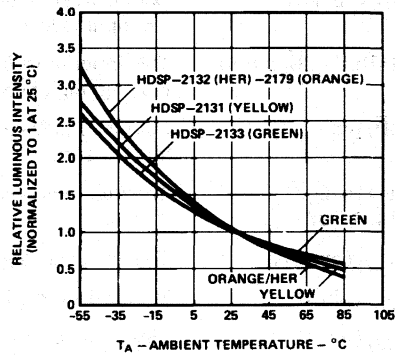

## Electrical Description

### Pin Function

RESET ( $\overline{\text{RST}}$ , pin 5)

Reset initializes the display.

FLASH ( $\overline{\text{FL}}$ , pin 27)

$\overline{\text{FL}}$  low indicates an access to the Flash RAM and is unaffected by the state of address lines  $A_3$ - $A_4$ .

ADDRESS INPUTS  
( $A_0$ - $A_4$ , pins 28-32)

Each location in memory has a distinct address. Address inputs ( $A_0$ - $A_2$ ) select a specific location in the Character RAM, the Flash RAM or a particular row in the UDC (User-Defined Character) RAM.  $A_3$ - $A_4$  are used to select which section of memory is accessed. Table 1 shows the logic levels needed to access each section of memory.

**Table 1. Logic Levels to Access Memory**

$\overline{\text{FL}}$	$A_4$	$A_3$	Section of Memory	$A_2$ $A_1$ $A_0$
0	X	X	Flash RAM	Character Address
1	0	0	UDC Address Register	Don't Care
1	0	1	UDC RAM	Row Address
1	1	0	Control Word Register	Don't Care
1	1	1	Character RAM	Character Address

CLOCK SELECT  
(CLS, pin 1)

This input is used to select either an internal (CLS = 1) or external (CLS = 0) clock source.

CLOCK INPUT/OUTPUT  
(CLK, pin 2)

Outputs the master clock (CLS = 1) or inputs a clock (CLS = 0) for slave displays.

WRITE ( $\overline{\text{WR}}$ , pin 3)

Data is written into the display when the  $\overline{\text{WR}}$  input is low and the  $\overline{\text{CE}}$  input is low.

CHIP ENABLE ( $\overline{\text{CE}}$ , pin 4)

This input must be at a logic low to read or write data to the display and must go high between each read and write cycle.

READ ( $\overline{\text{RD}}$ , pin 6)

Data is read from the display when the  $\overline{\text{RD}}$  input is low and the  $\overline{\text{CE}}$  input is low.

DATA Bus ( $D_0$ - $D_7$ ,  
pins 11-14, 19-22)

The Data bus is used to read from or write to the display.

$\text{GND}_{(\text{SUPPLY})}$  (pin 17)

This is the analog ground for the LED drivers.

$\text{GND}_{(\text{LOGIC})}$  (pin 18)

This is the digital ground for internal logic.

$V_{\text{DD}(\text{POWER})}$  (pin 16)

This is the positive power supply input.

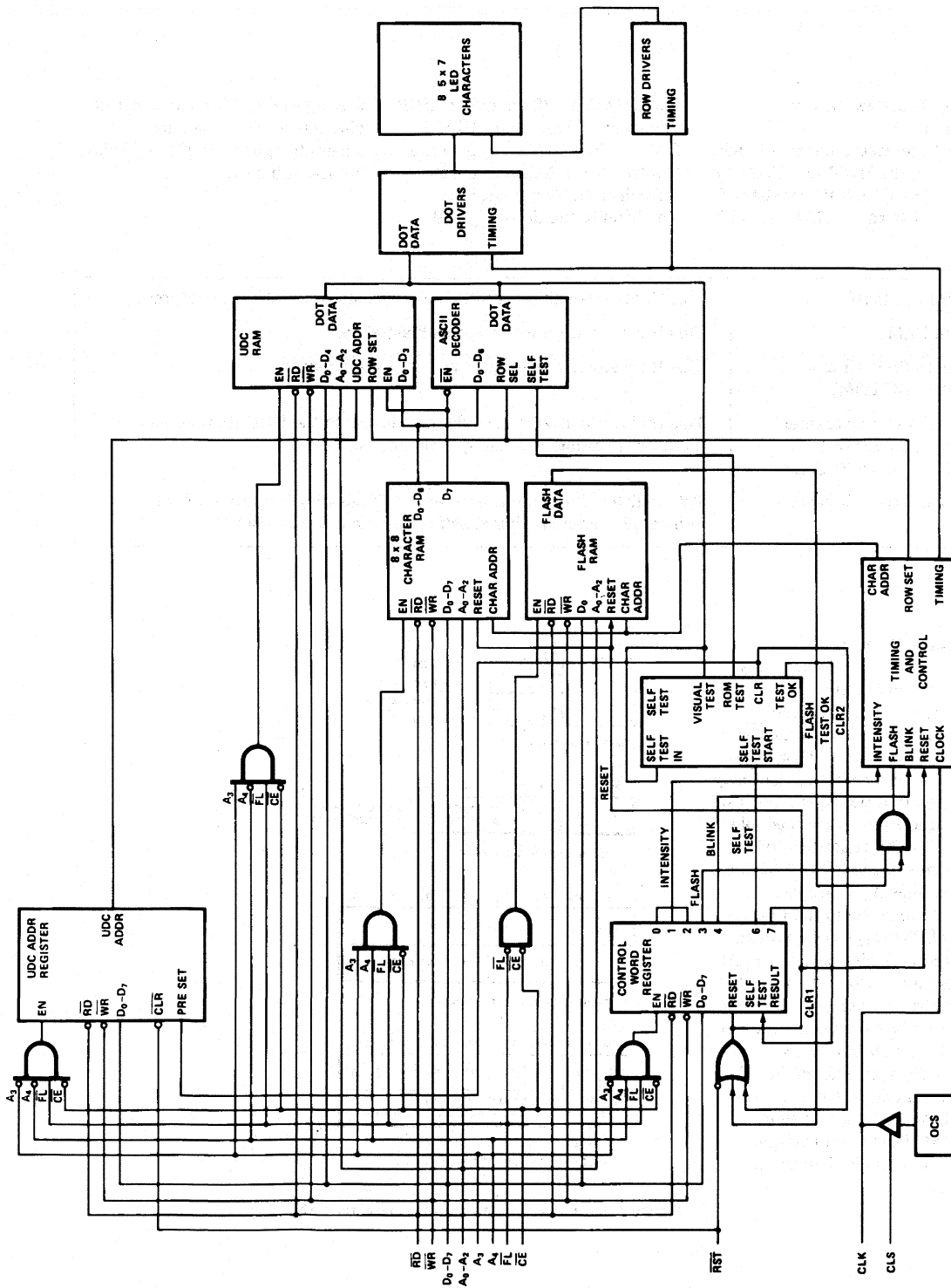

Figure 1. HDSP-213X/-2179 Internal Block Diagram.

GLASS/CERAMIC  
DISPLAYS

### Display Internal Block Diagram

Figure 1 shows the internal block diagram of the HDSP-213X/-2179 display. The CMOS IC consists of an 8 byte Character RAM, an 8 bit

Flash RAM, a 128 character ASCII decoder, a 16 character UDC RAM, a UDC Address Register, a Control Word Register, and the refresh circuitry necessary to synchronize the decoding and

driving of eight 5 x 7 dot matrix characters. The major user accessible portions of the display are listed below:

Character RAM	This RAM stores either ASCII character data or a UDC RAM address.
Flash RAM	This is a 1 x 8 RAM which stores Flash data.
User-Defined Character RAM (UDC RAM)	This RAM stores the dot pattern for custom characters.
User-defined Character Address Register (UDC Address Register)	This register is used to provide the address to the UDC RAM when the user is writing or reading a custom character.
Control Word Register	This register allows the user to adjust the display brightness, flash individual characters, blink, self test or clear the display.

### Character Ram

Figure 2 shows the logic levels needed to access the HDSP-213X Character RAM. During a normal access the  $\overline{CE}$  = "0" and either  $\overline{RD}$  = "0" or  $\overline{WR}$  = "0". However, erroneous data may be written into the Character RAM if the Address lines are unstable when  $\overline{CE}$  = "0" regardless of the logic levels of the  $\overline{RD}$  or  $\overline{WR}$  lines. Address lines  $A_0$ - $A_2$  are used to select the location in the Character RAM. Two types of data can be stored in each Character RAM location: an ASCII code or a UDC RAM address. Data bit  $D_7$  is used to differentiate between an ASCII character and a UDC RAM address.  $D_7 = 0$  enables the ASCII decoder and  $D_7 = 1$  enables the UDC RAM.  $D_0$ - $D_6$  are used to input ASCII data and  $D_0$ - $D_3$  are used to input a UDC address.

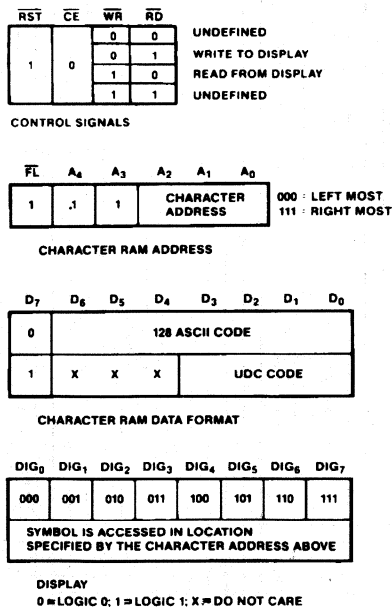

Figure 2. Logic Levels to Access the Character RAM.

### UDC RAM and UDC Address Register

Figure 3 shows the logic levels needed to access the UDC RAM and the UDC Address Register. The UDC Address Register is eight bits wide. The lower four bits (D<sub>0</sub>-D<sub>3</sub>) are used to select one of the 16 UDC locations. The upper four bits (D<sub>4</sub>-D<sub>7</sub>) are not used. Once the UDC address has been stored in the UDC Address Register, the UDC RAM can be accessed.

To completely specify a 5 x 7 character requires eight write cycles. One cycle is used to store the UDC RAM address in the UDC Address Register. Seven cycles are used to store dot data in the UDC RAM. Data is entered by rows. One cycle is needed to access each row. Figure 4 shows the organization of a UDC character assuming the symbol to be stored is an "F." A<sub>0</sub>-A<sub>2</sub> are used to select the row to be accessed and D<sub>0</sub>-D<sub>4</sub> are used to transmit the row dot data. The upper three bits (D<sub>5</sub>-D<sub>7</sub>) are ignored. D<sub>0</sub> (least significant bit) corresponds to the right most column of the 5 x 7 matrix and D<sub>4</sub> (most significant bit) corresponds to the left most column of the 5 x 7 matrix.

### Flash RAM

Figure 5 shows the logic levels needed to access the Flash RAM. The Flash RAM has one bit associated with each location of the Character RAM. The Flash input is used to select the Flash RAM. Address lines A<sub>3</sub>-A<sub>4</sub> are ignored. Address lines A<sub>0</sub>-A<sub>2</sub> are used to select the location in the Flash RAM to store the attribute. D<sub>0</sub> is used to store or remove the flash attribute. D<sub>0</sub> = "1" stores the attribute and D<sub>0</sub> = "0" removes the attribute.

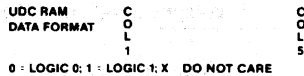
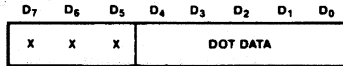
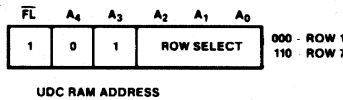
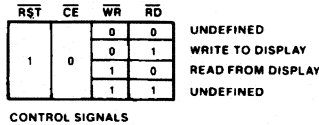
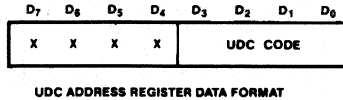
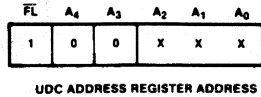
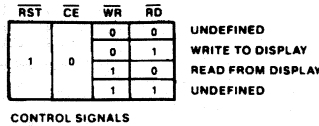
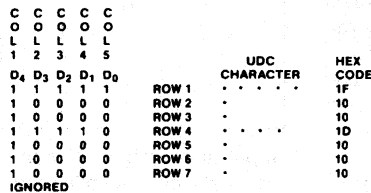

Figure 3. Logic Levels to Access a UDC Character.



0 = LOGIC 0; 1 = LOGIC 1; • = ILLUMINATED LED.

Figure 4. Data to Load "F" into the UDC RAM.

When the attribute is enabled through bit 3 of the Control Word and a "1" is stored in the Flash RAM, the corresponding character will flash at approximately 2 Hz.

The actual rate is dependent on the clock frequency. For an external clock the flash rate can be calculated by dividing the clock frequency by 28,672.

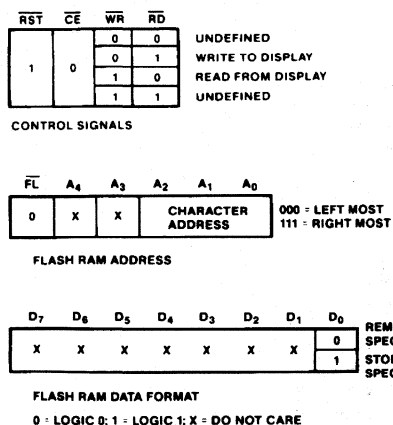

Figure 5. Logic Levels to Access the Flash RAM.

### Control Word Register

Figure 6 shows how to access the Control Word Register. This is an eight bit register which performs five functions. They are Brightness control, Flash RAM control, Blinking, Self Test and Clear. Each function is independent of the others. However, all bits are updated during each Control Word write cycle.

### Brightness (Bits 0-2)

Bits 0-2 of the Control Word adjust the brightness of the display. Bits 0-2 are interpreted as a three bit binary code with code (000) corresponding to maximum brightness and code (111) corresponding to a blanked display. In addition to varying the display brightness, bits 0-2 also vary the average value of  $I_{DD}$ .  $I_{DD}$  can be calculated at any brightness level by multiplying the percent brightness level by the value of  $I_{DD}$  at the 100% brightness level. These values of  $I_{DD}$  are shown in Table 2.

### Flash Function (Bit 3)

Bit 3 determines whether the flashing character attribute is on or off. When bit 3 is a "1," the output of the Flash RAM is checked. If the content of a location in the Flash RAM is a "1," the associated digit will flash at

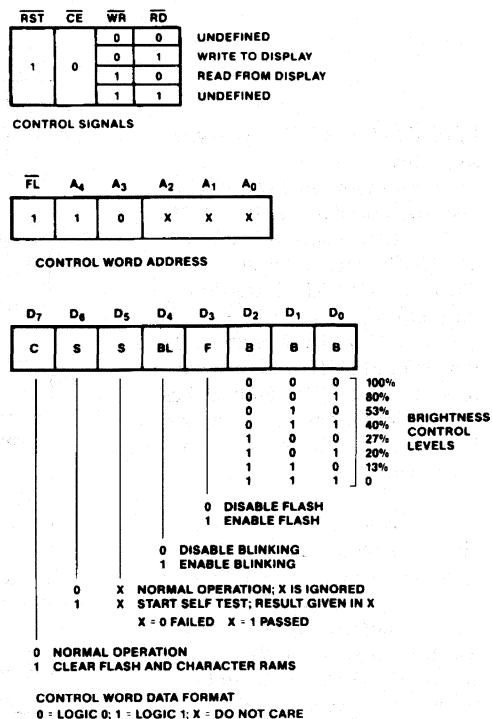

Figure 6. Logic Levels to Access the Control Word Register

Table 2. Current Requirements at Different Brightness Levels

Symbol	D <sub>2</sub>	D <sub>1</sub>	D <sub>0</sub>	% Brightness	25°C Typical	Units
$I_{DD}$ (V)	0	0	0	100	200	mA
	0	0	1	80	160	mA
	0	1	0	53	106	mA
	0	1	1	40	80	mA
	1	0	0	27	54	mA
	1	0	1	20	40	mA
	1	1	0	13	26	mA

approximately 2 Hz. For an external clock, the blink rate can be calculated by driving the clock frequency by 28,672. If the flash enable bit of the Control Word is a "0," the content of the Flash RAM is ignored. To use this function with multiple display systems see the Reset section.

### Blink Function (Bit 4)

Bit 4 of the Control Word is used to synchronize blinking of all

eight digits of the display. When this bit is a "1" all eight digits of the display will blink at approximately 2 Hz. The actual rate is dependent on the clock frequency. For an external clock, the blink rate can be calculated by dividing the clock frequency by 28,672. This function will override the Flash function when it is active. To use this function with multiple display systems see the Reset section.



### Self Test Function (Bits 5, 6)

Bit 6 of the Control Word Register is used to initiate the self test function. Results of the internal self test are stored in bit 5 of the Control Word. Bit 5 is a read only bit where bit 5 = "1" indicates a passed self test and bit 5 = "0" indicates a failed self test.

Setting bit 6 to a logic 1 will start the self test function. The built-in self test function of the IC consists of two internal routines which exercises major portions of the IC and illuminates all of the LEDs. The first routine cycles the ASCII decoder ROM through all states and performs a checksum on the output. If the checksum agrees with the correct value, bit 5 is set to "1." The second routine provides a visual test of the LEDs using the drive circuitry. This is accomplished by writing checkered and inverse checkered patterns to the display. Each pattern is displayed for approximately 2 seconds.

During the self test function the display must not be accessed. The time needed to execute the self test function is calculated by multiplying the clock period by 262,144. For example, assume a clock frequency of 58 KHz, then the time to execute the self test function frequency is equal to  $(262,144/58,000) = 4.5$  second duration.

At the end of the self test function, the Character RAM is loaded with blanks, the Control Word Register is set to zeros except for bit 5, and the Flash RAM is cleared and the UDC Address Register is set to all ones.

### Clear Function (Bit 7)

Bit 7 of the Control Word will clear the Character RAM and the Flash RAM. Setting bit 7 to a "1" will start the clear function. Three clock cycles (110  $\mu$ s min. using the internal refresh clock) are required to complete the clear function. The display must not be accessed while the display is being cleared. When the clear function has been completed, bit 7 will be reset to a "0." The ASCII character code for a space (20H) will be loaded into the Character RAM to blank the display and the Flash RAM will be loaded with "0"s. The UDC RAM, UDC Address Register, and the remainder of the Control Word are unaffected.

### Display Reset

Figure 7 shows the logic levels needed to Reset the display. The display should be Reset on Power-up. The external Reset clears the Character RAM, Flash RAM, Control Word and resets the internal counters. After the rising edge of the Reset signal, three clock cycles (110  $\mu$ s min. using the internal refresh clock) are required to complete the reset sequence. The display must not be accessed while the display is being reset. The ASCII Character code for a space (20H) will be loaded into the Character RAM to blank the display. The Flash RAM and Control Word Register are loaded with all "0"s. The UDC RAM and UDC Address Register

RST	CE	WR	RD	FL	A <sub>7</sub> -A <sub>0</sub>	D <sub>7</sub> -D <sub>0</sub>
0	1	X	X	X	X	X

0 = LOGIC 0; 1 = LOGIC 1; X = DO NOT CARE  
NOTE:  
IF RST, CE AND WR ARE LOW, UNKNOWN  
DATA MAY BE WRITTEN INTO THE DISPLAY.

Figure 7. Logic Levels to Reset the Display.

are unaffected. All displays which operate with the same clock source must be simultaneously reset to synchronize the Flashing and Blinking functions.

### Mechanical and Electrical Considerations

The HDSP-213X/-2179 is a 32 pin dual-in-line package with 24 external pins, which can be stacked horizontally and vertically to create arrays of any size. The HDSP-213X/-2179 is designed to operate continuously from -55°C to +85°C with a maximum of 20 dots ON per character. Illuminating all thirty-five dots at full brightness is not recommended.

The HDSP-213X/-2179 is assembled by die attaching and wire bonding 280 LED chips and a CMOS IC to a ceramic substrate. A glass window is placed over the ceramic substrate creating an air gap over the LED wire bonds. A second glass window creates an air gap over the CMOS IC. This package construction makes the display highly tolerant to temperature cycling and allows wave soldering and visual inspection of the IC.

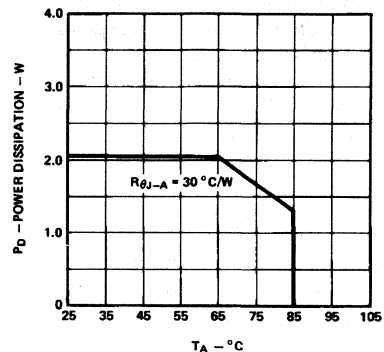

Figure 8. Maximum Power Dissipation vs. Ambient Temperature Derating Based on T<sub>J</sub>MAX = 125°C.

The inputs to the CMOS IC are protected against static discharge and input current latchup. However, for best results standard CMOS handling precautions should be used. Prior to use, the HDSP-213X should be stored in antistatic packages or conductive material. During assembly, a grounded conductive work area should be used, and assembly personnel should wear conductive wrist straps. Lab coats made of synthetic material should be avoided since they are prone to static charge buildup. Input current latchup is caused when the CMOS inputs are subjected to either a voltage below ground ( $V_{IN} < \text{ground}$ ) or to a voltage higher than  $V_{DD}$  ( $V_{IN} > V_{DD}$ ) and when a high current is forced into the input. To prevent input current latchup and ESD damage, unused inputs should be connected either to ground or to  $V_{DD}$ . Voltages should not be applied to the inputs until  $V_{DD}$  has been applied to the display. Transient input voltages should be eliminated.

### Thermal Considerations

The HDSP-213X/-2179 has been designed to provide a low thermal resistance path from the CMOS IC to the 24 package pins. This heat is then typically conducted through the traces of the user's printed circuit board to free air. For most applications no additional heatsinking is required.

The maximum operating IC junction temperature is 150°C. The maximum IC junction temperature can be calculated using the following equation:

$$T_J(\text{IC}) \text{ MAX} = T_A + (P_D \text{ MAX}) (R\theta_{J-PIN} + R\theta_{PIN-A})$$

Where

$$P_D \text{ MAX} = (V_{DD} \text{ MAX}) (I_{DD} \text{ MAX})$$

$I_{DD} \text{ MAX} = 370 \text{ mA}$  with 20 dots ON in eight character locations at 25°C ambient. This value is from the Electrical Characteristics table.

$$P_D \text{ MAX} = (5.5 \text{ V}) (0.370 \text{ A}) = 2.04 \text{ W}$$

### Ground Connections

Two ground pins are provided to keep the internal IC logic ground clean. The designer can, when necessary, route the analog ground for the LED drivers separately from the logic ground until an appropriate ground plane is available. On long interconnects between the display and the host system, the designer can keep voltage drops on the analog ground from affecting the display logic levels by isolating the two grounds.

The logic ground should be connected to the same ground potential as the logic interface circuitry. The analog ground and the logic ground should be connected at a common ground which can withstand the current introduced by the switching LED drivers. When separate ground connections are used, the analog ground can vary from -0.3 V to +0.3 V with respect to the logic ground. Voltage below -0.3 V can cause all dots to be on. Voltage above +0.3 V can cause dimming and dot mismatch.

### ESD Susceptibility

These displays have ESD susceptibility ratings of CLASS 3 per DOD-STD-1686 and CLASS B per MIL-STD-883C.

### Soldering and Post Solder Cleaning Instructions for the HDSP-213X/-2179

The HDSP-213X/-2179 may be hand soldered or wave soldered with SN63 solder. When hand soldering it is recommended that an electronically temperature controlled and securely grounded soldering iron be used. For best results, the iron tip temperature should be set at 315°C (600°F). For wave soldering, a rosin-based RMA flux can be used. The solder wave temperature should be set at 245°C ± 5°C (473°F ± 9°F), and dwell in the wave should be set between 1½ to 3 seconds for optimum soldering. The preheat temperature should not exceed 105°C (221°F) as measured on the solder side of the PC board.

For further information on soldering and post solder cleaning, see Application Note 1027, *Soldering LED Components*.

### Contrast Enhancement

When used with the proper contrast enhancement filters, the HCMS-213X/-2179 series displays are readable daylight ambients. Refer to Application Note 1029 *Luminous Contrast and Sunlight Readability of the HDSP-235X Series Alphanumeric Displays for Military Applications* for information on contrast enhancement for daylight

ambients. Refer to Application Note 1015 *Contrast Enhancement Techniques for LED Displays* for information on contrast enhancement in moderate ambients.

### **Night Vision Lighting**

When used with the proper NVG/DV filters, the HDSP-2131, HDSP-2179 and HDSP-2133 may be used in night

vision lighting applications. The HDSP-2131 (yellow), HDSP-2179 (orange) displays are used as master caution and warning indicators. The HDSP-2133 (high performance green) displays are used for general instrumentation. For a list of NVG/DV filters and a discussion on night vision lighting technology, refer to Application Note 1030 *LED Displays and Indicators and Night Vision*

*Imaging System Lighting*. An external dimming circuit must be used to dim these displays to night vision lighting levels to meet NVIS radiance requirements. Refer to AN 1039 *Dimming HDSP-213X Displays to Meet Night Vision Lighting Levels*.

---

# CMOS Extended Temperature Range 5 x 7 Alphanumeric Displays

## Technical Data

---

**HCMS-201X Series  
HCMS-231X  
HCMS-235X Series**

---

### Features

- **On-Board Low Power CMOS IC**  
Integrated Shift Register with Constant Current LED Drivers
- **Wide Operating Temperature Range**  
-55°C to +100°C
- **Compact Glass Ceramic 4 Character Package**  
HCMS-201X Series X-Stackable  
HCMS-231X/-235X Series X-Y Stackable
- **HCMS-235X Series are Sunlight Viewable**
- **Five Colors**  
Standard Red  
High Efficiency Red  
Orange  
Yellow  
High Performance Green
- **5 x 7 LED Matrix Displays Full ASCII Set**
- **Two Character Heights**  
3.8 mm (0.15 inch)  
5.0 mm (0.20 inch)

- **Wide Viewing Angle**  
X Axis =  $\pm 50^\circ$   
Y Axis =  $\pm 65^\circ$
- **Long Viewing Distance**  
HCMS-201X Series to 2.6 Meters (8.6 Feet)  
HCMS-231X/-235X Series to 3.5 Meters (11.5 Feet)
- **Categorized for Luminous Intensity**
- **HCMS-2011/2013  
HCMS-2311/-2313/-2314  
HCMS-2351/-2353/-2354**  
Useable in Night Vision Lighting Applications
- **HCMS-2011/-2013,  
HCMS-2311/-2313 and  
HCMS-2351/-2353:**  
Categorized for Color

### Typical Applications

- **Avionics**
- **Communications Systems**
- **Radar Systems**
- **Fire Control Systems**

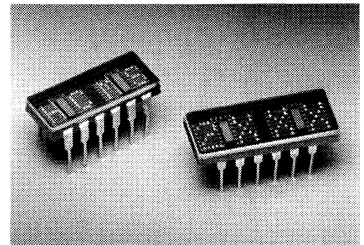

### Description

The HCMS-201X, HCMS-231X and the sunlight viewable HCMS-235X series are 5 x 7 LED four character displays contained in 12 pin dual-in-line packages designed for displaying alphanumeric information. The character height for the HCMS-201X series displays is 3.8 mm (0.15 inch), and for the HCMS-231X and HCMS-235X series displays the character height is 5.0 mm (0.20 inch). The HCMS-201X series displays are available in four LED colors: standard red, high efficiency red, yellow and high performance green. The HCMS-231X series are available in all

ESD WARNING: STANDARD CMOS HANDLING PRECAUTIONS SHOULD BE OBSERVED.

five LED colors. The HCMS-235X series displays are available in four LED colors: high efficiency red, orange, yellow and high performance green. The HCMS-201X series displays are end stackable. The HCMS-231X and HCMS-235X series displays are end/row stackable.

These displays are designed with on-board CMOS integrated circuits for use in applications

where conservation of power is important. The two CMOS ICs form an on-board 28-bit serial-in-parallel-out shift register with constant current output LED row drivers. Decoded column data is clocked into the on-board shift register for each refresh cycle. Full character display is achieved with external column strobing.

### Compatibility with HDSP-201X/-231X/-235X TTL IC Series Displays

The HCMS-201X, HCMS-231X and HCMS-235X CMOS IC displays are "drop-in" replacements for the equivalent HDSP-201X, HDSP-231X and HDSP-235X TTL IC displays. The 12 pin glass/ceramic package configuration, four digit character matrix and pin functions are identical.

### Display Selection Table

Part Number	Character Size	LED Color
HCMS-2010	3.8 mm (0.15 inch)	Standard Red
HCMS-2011	3.8 mm (0.15 inch)	Yellow
HCMS-2012	3.8 mm (0.15 inch)	High-Efficiency Red
HCMS-2013	3.8 mm (0.15 inch)	High-Performance Green
HCMS-2310	5.0 mm (0.20 inch)	Standard Red
HCMS-2311	5.0 mm (0.20 inch)	Yellow
HCMS-2312	5.0 mm (0.20 inch)	High-Efficiency Red
HCMS-2313	5.0 mm (0.20 inch)	High-Performance Green
HCMS-2314	5.0 mm (0.20 inch)	Orange
<b>Sunlight Viewable Displays</b>		
HCMS-2351	5.0 mm (0.20 inch)	Yellow
HCMS-2352	5.0 mm (0.20 inch)	High-Efficiency Red
HCMS-2353	5.0 mm (0.20 inch)	High-Performance Green
HCMS-2354	5.0 mm (0.20 inch)	Orange

GLASS/CERAMIC DISPLAYS



### Absolute Maximum Ratings

- Supply Voltage  $V_{DD}$  to Ground ..... -0.3 V to 7.0 V
- Data Input, Data Output,  $V_B$  ..... -0.3 V to  $V_{DD}$
- Column Input Voltage,  $V_{COL}$  ..... -0.3 V to  $V_{DD}$
- Free Air Operating Temperature Range,  $T_A$  ..... -55°C to +100°C
- Storage Temperature Range,  $T_S$  ..... -65°C to +125°C
  - HCMS-2310/-2311/-2312/-2314
  - HCMS-2351/-2352/-2354
- Storage Temperature Range,  $T_S$  ..... -55°C to +100°C
  - HCMS-2010/-2011/-2012/-2013
  - HCMS-2313
  - HCMS-2353
- Maximum Allowable Package Power Dissipation,  $P_D$ <sup>[1,2]</sup>
  - HCMS-2010/-2011/-2012/-2013 at  $T_A = 83^\circ\text{C}$  ..... 0.79 Watts
  - HCMS-2310/-2311/-2312/-2313/-2314 at  $T_A = 88^\circ\text{C}$  ..... 0.92 Watts
  - HCMS-2351/-2352/-2353/-2354 at  $T_A = 71^\circ\text{C}$  ..... 1.31 Watts
- Maximum Solder Temperature
  - 1.59 mm (0.063") Below Seating Plane,  $t \leq 5$  sec ..... 260°C
- ESD Protection @ 1.5 k $\Omega$ , 100 pf .....  $V_Z = 4$  kV (each pin)

**Notes:**

1. Maximum allowable power dissipation is derived from  $V_{DD} = 5.25$  V,  $V_B = 2.4$  V,  $V_{COL} = 3.5$  V, 20 LEDs ON per character, 20% DF.
  2. The power dissipation for these displays should be derated as follows:
    - HCMS-201X series derate above 83°C at 17 mW/°C,  $R\theta_{J-A} = 60^\circ\text{C/W}$
    - HCMS-231X series derate above 88°C at 22 mW/°C,  $R\theta_{J-A} = 45^\circ\text{C/W}$
    - HCMS-235X series derate above 71°C at 23 mW/°C,  $R\theta_{J-A} = 45^\circ\text{C/W}$
- Deratings based on  $R\theta_{PC-A} = 35^\circ\text{C/W}$  per display for printed circuit board assembly.  
See Figure 1 for power derating based on lower  $R\theta_{J-A}$  values.

### Recommended Operating Conditions Over Operating Temperature Range (-55°C to +100°C)

Parameter	Symbol	Min.	Typ.	Max.	Units
Supply Voltage	$V_{DD}$	4.75	5.00	5.25	V
Data Out Current, Low State	$I_{OL}$			1.6	mA
Data Out Current, High State	$I_{OH}$			-0.5	mA
Column Input Voltage	$V_{COL}$	2.75	3.0	3.5	V
Setup Time	$t_{SETUP}$	10			ns
Hold Time	$t_{HOLD}$	25			ns
Clock Pulse Width High	$t_{WH(CLOCK)}$	50			ns
Clock Pulse Width Low	$t_{WL(CLOCK)}$	50			ns
Clock High to Low Transition	$t_{THL}$			200	ns
Clock Frequency	$f_{CLOCK}$			5	MHz

## Electrical Characteristics over Operating Temperature Range (-55°C to +100°C)

Parameter	Symbol	Test Conditions	Min.	Typ.*	Max.	Units
Supply Current, Dynamic <sup>[1]</sup>	$I_{DD}$	$f_{CLOCK} = 5 \text{ MHz}$		6.2	7.8	mA
Supply Current, Static <sup>[2]</sup>	$I_{DD\text{Soff}}$ $I_{DD\text{Son}}$	$V_B = 0.4 \text{ V}$ $V_B = 2.4 \text{ V}$		1.8 2.2	2.6 6.0	mA
Column Input Current	$I_{COL}$	$V_B = 0.4 \text{ V}$			10	$\mu\text{A}$
HCMS-2010/-2011/-2012/-2013		$V_B = 2.4 \text{ V}$		310	384	mA
HCMS-2310/-2311/-2312/-2313/-2314		$V_B = 2.4 \text{ V}$		360	451	mA
HCMS-2351/-2352/-2353/-2354		$V_B = 2.4 \text{ V}$		500	650	mA
Input Logic High Data, $V_B$ , Clock	$V_{IH}$	$V_{DD} = 4.75 \text{ V}$	2.0			V
Input Logic Low Data, $V_B$ , Clock	$V_{IL}$	$V_{DD} = 5.25 \text{ V}$			0.8	V
Input Current Data, Clock $V_B$	$I_I$	$V_{DD} = 5.25 \text{ V}$ $0 \leq V_I \leq 5.25 \text{ V}$ $0 \leq V_B \leq 5.25 \text{ V}$	-10 -40		+10 0	$\mu\text{A}$
Data Out Voltage	$V_{OH}$	$V_{DD} = 4.75 \text{ V}$ $I_{OH} = -0.5 \text{ mA}$ $I_{COL} = 0 \text{ mA}$	2.4	4.2		V
	$V_{OL}$	$V_{DD} = 5.25 \text{ V}$ $I_{OL} = 1.6 \text{ mA}$ $I_{COL} = 0 \text{ mA}$		0.2	0.4	V
Power Dissipation Per Package <sup>[3]</sup>	$P_D$	$V_{DD} = 5.0 \text{ V}$		414		mW
HCMS-2010/-2011/-2012/-2013		$V_{COL} = 3.5 \text{ V}$		481		
HCMS-2310/-2311/-2312/-2313/-2314		17.5% DF		668		
HCMS-2351/-2352/-2353/-2354		$V_B = 2.4 \text{ V}$ 15 LEDs ON per Character				
Thermal Resistance IC Junction-to-Pin <sup>[4]</sup>	$R\theta_{J-PIN}$			25		$^{\circ}\text{C/W}$
HCMS-2010/-2011/-2012/-2013				10		
HCMS-2310/-2311/-2312/-2313/-2314				10		
HCMS-2351/-2352/-2353/-2354						
Leak Rate					$5 \times 10^{-8}$	cc/sec

\*All typical values specified at  $V_{DD} = 5.0\text{V}$  and  $T_A = 25^{\circ}\text{C}$ .

### Notes:

- $I_{DD}$  Dynamic is the IC current while clocking column data through the on-board shift register at a clock frequency of 5MHz, the display is not illuminated.
- $I_{DD}$  Static is the IC current after column data is loaded and not being clocked through the on-board shift register.
- Four characters are illuminated with a typical ASCII character composed of 15 dots per character.
- IC junction temperature  $T_J(\text{IC}) = (P_D)(R\theta_{J-PIN} + R\theta_{PC-A}) + T_A$ .



**Optical Characteristics at  $T_A = 25^\circ\text{C}$** **Standard Red HCMS-2010/-2310**

Description	Symbol	Test Condition	Min.	Typ.	Max.	Units
Peak Luminous Intensity per LED <sup>[5,9]</sup> (Character Average) HCMS-2010 HCMS-2310	$I_{VPEAK}$	$V_{DD} = 5.0\text{ V}$ $V_{COL} = 3.5\text{ V}$ $V_B = 2.4\text{ V}$ $T_1 = 25^\circ\text{C}^{[7]}$	105 220	200 370		$\mu\text{cd}$
Dominant Wavelength <sup>[8]</sup>	$\lambda_d$			639		nm
Peak Wavelength	$\lambda_{PEAK}$			655		nm

**Yellow HCMS-2011/-2311/-2351**

Description	Symbol	Test Condition	Min.	Typ.	Max.	Units
Peak Luminous Intensity per LED <sup>[5,9]</sup> (Character Average) HCMS-2011 HCMS-2311 HCMS-2351	$I_{VPEAK}$	$V_{DD} = 5.0\text{ V}$ $V_{COL} = 3.5\text{ V}$ $V_B = 2.4\text{ V}$ $T_1 = 25^\circ\text{C}^{[7]}$	400 650 2400	750 1140 3400		$\mu\text{cd}$
Dominant Wavelength <sup>[6,8]</sup>	$\lambda_d$			585		nm
Peak Wavelength	$\lambda_{PEAK}$			583		nm

**High Efficiency Red HCMS-2012/-2312/-2352**

Description	Symbol	Test Condition	Min.	Typ.	Max.	Units
Peak Luminous Intensity per LED <sup>[5,9]</sup> (Character Average) HCMS-2012 HCMS-2312 HCMS-2352	$I_{VPEAK}$	$V_{DD} = 5.0\text{ V}$ $V_{COL} = 3.5\text{ V}$ $V_B = 2.4\text{ V}$ $T_1 = 25^\circ\text{C}^{[7]}$	400 650 1920	1430 1430 2850		$\mu\text{cd}$
Dominant Wavelength <sup>[8]</sup>	$\lambda_d$			625		nm
Peak Wavelength	$\lambda_{PEAK}$			635		nm

**High Performance Green HCMS-2013/-2313/-2353**

Description	Symbol	Test Condition	Min.	Typ.	Max.	Units
Peak Luminous Intensity per LED <sup>[5,9]</sup> (Character Average) HCMS-2013 HCMS-2313 HCMS-2353	$I_{VPEAK}$	$V_{DD} = 5.0\text{ V}$ $V_{COL} = 3.5\text{ V}$ $V_B = 2.4\text{ V}$ $T_1 = 25^\circ\text{C}^{[7]}$	850 1280 2400	1550 2410 3000		$\mu\text{cd}$
Dominant Wavelength <sup>[6,8]</sup>	$\lambda_d$			574		nm
Peak Wavelength	$\lambda_{PEAK}$			568		nm

### Orange HCMS-2314/-2354

Description	Symbol	Test Condition	Min.	Typ.	Max.	Units
Peak Luminous Intensity per LED <sup>[5,9]</sup> HCMS-2314 (Character Average) HCMS-2354	$I_{VPEAK}$	$V_{DD} = 5.0\text{ V}$ $V_{COL} = 3.5\text{ V}$ $V_B = 2.4\text{ V}$ $T_i = 25^\circ\text{C}^{[7]}$	650 1920	1430 2850		$\mu\text{cd}$
Dominant Wavelength <sup>[8]</sup>	$\lambda_d$			602		nm
Peak Wavelength	$\lambda_{PEAK}$			600		nm

All typical values specified at  $V_{DD} = 5.0\text{ V}$  and  $T_A = 25^\circ\text{C}$  unless otherwise noted.

#### Notes:

- These LED displays are categorized for luminous intensity, with the intensity category designated by a letter code on the back of the package.
- The HCMS-2011/-2311/-2351 and HCMS-2013/-2313/-2353 are categorized for color with the color category designated by a number on the back of the package.
- $T_i$  refers to the initial case temperature of the display immediately prior to the light measurement.
- Dominant wavelength,  $\lambda_d$ , is derived from the CIE Chromaticity Diagram, and represents the single wavelength which defines the color of the device.
- The luminous sterance of the individual LED pixels may be calculated using the following equations:

$$L_v(\text{cd/m}^2) = I_v(\text{Candela}) * \text{DF}/A(\text{Metre})^2$$

$$L_v(\text{Footlamberts}) = \pi I_v(\text{Candela}) * \text{DF}/A(\text{Foot})^2$$

Where: A = LED pixel area =  $5.3 \times 10^{-8}\text{M}^2$  or  $5.8 \times 10^{-7}\text{ft}^2$   
DF = LED on-time duty factor

### Switching Characteristics, $T_A = -55^\circ\text{C}$ to $+100^\circ\text{C}$

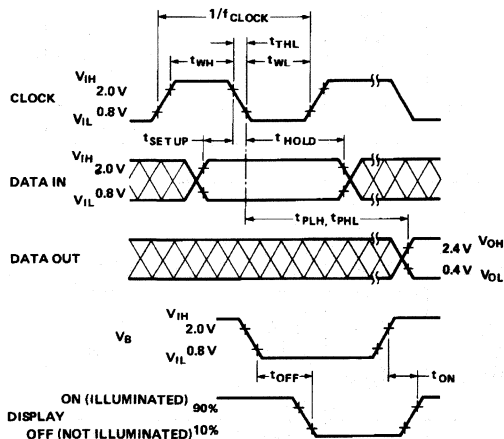

Parameter	Condition	Typ.	Max.	Units
$f_{clock}$ CLOCK Rate			5	MHz
$t_{PLH}$ , $t_{PHL}$ Propagation Delay CLOCK to DATA OUT	$C_L = 15\text{ pF}$ $R_L = 2.4\text{ k}\Omega$		105	ns
$t_{OFF}$ $V_B$ (0.4 V) to Display OFF		4	5	$\mu\text{s}$
$t_{ON}$ $V_B$ (2.4 V) to Display ON		1	2	

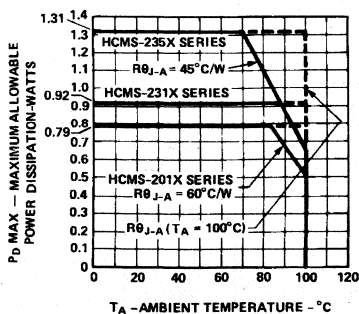
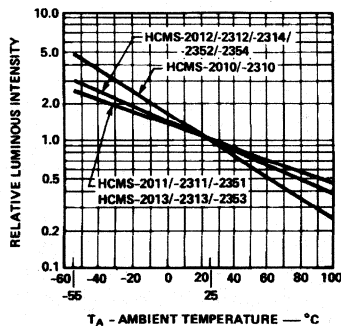

**Figure 1. Maximum Allowable Power Dissipation vs Ambient Temperature as a Function of Thermal Resistance Junction-to-Ambient,  $R_{\theta J-A}$ . Derated Operation Assumes  $R_{\theta PC-A} = 35^{\circ}\text{C/W}$  per Display for Printed Circuit Board.  $T_J$  (IC) MAX =  $130^{\circ}\text{C}$ .  $R_{\theta J-A}$  ( $T_A = 100^{\circ}\text{C}$ )**  
 =  $22^{\circ}\text{C/W}$  for HCMS-235X Series  
 =  $32^{\circ}\text{C/W}$  for HCMS-231X Series  
 =  $38^{\circ}\text{C/W}$  for HCMS-201X Series.

## Electrical Description

Each display device contains four  $5 \times 7$  LED dot matrix characters and two CMOS integrated circuits, as shown in Figure 4. The two CMOS integrated circuits form an on-board 28 bit serial-in-parallel-out shift register that will accept standard TTL logic levels. The Data Input, pin 12, is connected to bit position 1 and the Data Output, pin 7, is connected to bit position 28. The shift register outputs control constant current sinking LED row drivers. The nominal current sink per LED driver is 11 mA for the HCMS-201X displays, 13 mA for the HCMS-231X displays and 18 mA for the HCMS-235X displays. A logic 1 stored in the shift register enables the corresponding LED row driver and a logic 0 stored in the shift register disables the corresponding LED row driver.

The electrical configuration of these CMOS IC alphanumeric displays allows for an effective



**Figure 2. Relative Luminous Intensity vs Ambient Temperature.**

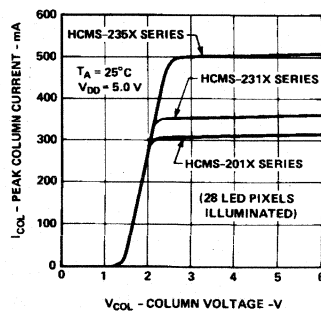

**Figure 3. Peak Column Current vs Column Voltage.**

interface to a display controller circuit that supplies decoded character information. The row data for a given column (one 7 bit byte per character) is loaded (bit serial) into the on-board 28 bit shift register with high to low transitions of the Clock input. To load decoded character information into the display, column data for character 4 is loaded first and the column data for character 1 is loaded last in the following manner. The 7 data bits for column 1, character 4, are loaded into the on-board shift register. Next, the 7 data bits for column 1, character 3, are loaded into the shift register, shifting the character 4 data over one character position. This process is repeated for the other two characters until all 28 bits of column data (four 7 bit bytes of character column data) are loaded into the on-board shift register. Then the column 1 input,  $V_{COL}$  pin 1, is energized to illuminate column 1 in all four characters. This process is repeated for columns

2, 3, 4 and 5. All  $V_{COL}$  inputs should be at logic low to insure the display is off when loading data. The display will be blanked when the blanking input  $V_B$ , pin 8, is at logic low regardless of the outputs of the shift register or whether one of the  $V_{COL}$  inputs is energized.

Refer to Application Note 1016 for drive circuit information.

## ESD Susceptibility

The HCMS-201X/-231X/-235X series displays have an ESD susceptibility ratings of CLASS 3 per DOD-STD-1686 and CLASS B per MIL-STD-883C. It is recommended that normal CMOS handling precautions be observed with these devices.

## Soldering and Post Solder Cleaning

These displays may be soldered with a standard wave solder process using either an RMA flux and solvent cleaning or an OA flux and aqueous cleaning. For

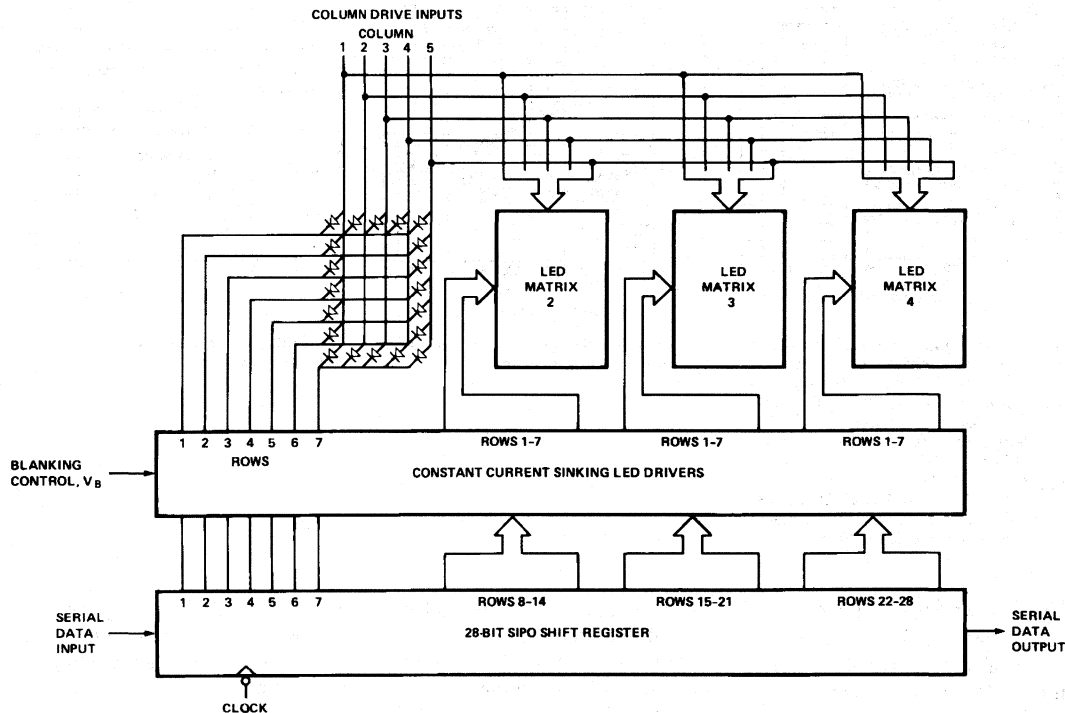

Figure 4. Block Diagram of an HCMS-2XXX Series LED Alphanumeric Display.

optimum soldering, the solder wave temperature should be 245°C and the dwell time for any display lead passing through the wave should be 1½ to 2 seconds. For more detailed information, refer to Application Note 1027 *Soldering LED Components*.

### Contrast Enhancement

When used with the proper contrast enhancement filters, the HCMS-235X series displays are readable in sunlight and the HCMS-201X/231X series displays are readable in daylight ambients. Refer to Application Note 1029 *Luminous Contrast and Sunlight Readability of the HDSP-235X Series Alphanumeric Displays* for Military

Applications for information on contrast enhancement for sunlight and daylight ambients. Refer to Application Note 1015 *Contrast Enhancement Techniques for LED Displays* for information on contrast enhancement in moderate ambients.

### Night Vision Lighting

When used with the proper NVG/DV filters, the HCMS-2311-/2351 and HCMS-2133-/2353 displays may be used in night vision lighting applications. The HCMS-2311-/2351 (yellow) displays are used as master caution and warning indicators. The HCMS-2313-/2353 (high performance green) displays are used for general instrumentation. For a

list of NVG/DV filters and a discussion on night vision lighting technology, refer to Application Note 1030 *LED Displays and Indicators and Night Vision Imaging System Lighting*.

### Controller Circuits, Power Calculations and Display Dimming

Refer to Application Note 1016 *Using the HDSP-2000 Alphanumeric Display Family* for information on controller circuits to drive these displays, how to do power calculations and a technique for display dimming.

# Glass/Ceramic Numeric and Hexadecimal Displays for Industrial Applications

## Technical Data

**4N51  
4N52  
4N53  
4N54**

### Features

- **Three Character Options**  
Numeric, Hexadecimal, Over Range
- **4 x 7 Dot Matrix Character**
- **Performance Guaranteed Over Temperature**
- **High Temperature Stabilized**
- **Solder Dipped Leads**
- **Memory Latch/Decoder/Driver**  
TTL Compatible
- **Categorized for Luminous Intensity**

### Description

These standard red solid state displays have a 7.4 mm (0.29 inch) dot matrix character and an on-board IC with data memory latch/decoder and LED drivers in a glass/ceramic package. These devices utilize a solder glass frit seal.

The 4N51 numeric display decodes positive 8421 BCD logic inputs into characters 0-9, a “-” sign, a test pattern, and four blanks in the invalid BCD states. The unit employs a right-hand decimal point.

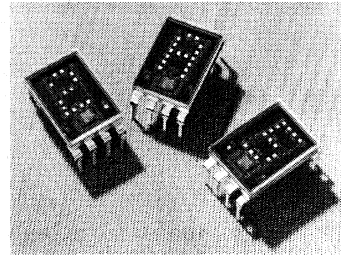

GLASS/CERAMIC  
DISPLAYS

### Package Dimensions\*

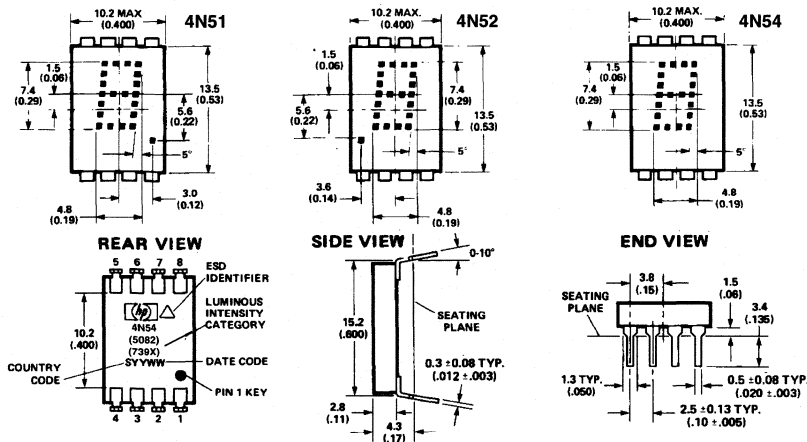

PIN	FUNCTION	
	4N51 4N52 NUMERIC	4N54 HEXA- DECIMAL
1	Input 2	Input 2
2	Input 4	Input 4
3	Input 8	Input 8
4	Decimal point	Blanking control
5	Latch enable	Latch enable
6	Ground	Ground
7	V <sub>CC</sub>	V <sub>CC</sub>
8	Input 1	Input 1

#### NOTES:

1. Dimensions in millimetres and (inches).
2. Unless otherwise specified, the tolerance on all dimensions is  $\pm 0.38\text{mm}$  ( $\pm 0.015''$ ).
3. Digit center line is  $\pm 0.25\text{mm}$  ( $\pm 0.01''$ ) from package center line.
4. Solder dipped leads.
5. See over range package drawing for HP standard marking.

\*JEDEC Registered Data.

The 4N52 is the same as the 4N51 except that the decimal point is located on the left side of the digit.

In place of the decimal point an input is provided for blanking the display (all LEDs off), without losing the contents of the memory.

The 4N54 hexadecimal display decodes positive 8421 logic inputs into 16 states, 0-9 and A-F.

The 4N53 is a "± 1." overrange display, including a right-hand decimal point.

### Absolute Maximum Ratings\*

Description	Symbol	Min.	Max.	Unit
Storage Temperature, Ambient	$T_S$	-65	+125	°C
Operating Temperature, Ambient <sup>[1,2]</sup>	$T_A$	-55	+100	°C
Supply Voltage <sup>[3]</sup>	$V_{CC}$	-0.5	+7.0	V
Voltage Applied to Input Logic, dp and Enable Pins	$V_I, V_{DP}, V_E$	-0.5	$V_{CC}$	V
Voltage Applied to Blanking Input <sup>[7]</sup>	$V_B$	-0.5	$V_{CC}$	V
Maximum Solder Temperature at 1.59 mm (0.062 inch) Below Seating Plane; $t \leq 5$ Seconds			260	°C

### Recommended Operating Conditions\*

Description	Symbol	Min.	Nom.	Max.	Unit
Supply Voltage	$V_{CC}$	4.5	5.0	5.5	V
Operating Temperature, Ambient <sup>[1,2]</sup>	$T_A$	-55		+100	°C
Enable Pulse Width	$t_W$	100			nsec
Time Data Must Be Held Before Positive Transition of Enable Line	$t_{SETUP}$	50			nsec
Time Data Must Be Held After Positive Transition of Enable Line	$t_{HOLD}$	50			nsec
Enable Pulse Rise Time	$t_{TLH}$			200	nsec

\*JEDEC Registered Data.

**Electrical/Optical Characteristics\*** $T_A = -55^\circ\text{C}$  to  $+100^\circ\text{C}$ , unless otherwise specified

Description	Symbol	Test Conditions	Min.	Typ. <sup>[4]</sup>	Max.	Unit
Supply Current	$I_{CC}$	$V_{CC} = 5.5\text{ V}$		112	170	mA
Power Dissipation	$P_T$	(Characters "5." or "B")		560	935	mW
Luminous Intensity per LED (Digit Average) <sup>[5,6]</sup>	$I_v$	$V_{CC} = 5.0\text{ V}$ , $T_A = 25^\circ\text{C}$	40	85		$\mu\text{cd}$
Logic Low-Level Input Voltage	$V_{IL}$	$V_{CC} = 4.5\text{ V}$			0.8	V
Logic High-Level Input Voltage	$V_{IH}$		2.0			V
Enable Low-Voltage; Data Being Entered	$V_{EL}$				0.8	V
Enable High-Voltage; Data Not Being Entered	$V_{EH}$		2.0			V
Blanking Low-Voltage; Display Not Blanked <sup>[7]</sup>	$V_{BL}$				0.8	V
Blanking High-Voltage; Display Blanked <sup>[7]</sup>	$V_{BH}$		3.5			V
Blanking Low-Level Input Current <sup>[7]</sup>	$I_{BL}$		$V_{CC} = 5.5\text{ V}$ , $V_{BL} = 0.8\text{ V}$			50
Blanking High-Level Input Current <sup>[7]</sup>	$I_{BH}$	$V_{CC} = 5.5\text{ V}$ , $V_{BH} = 4.5\text{ V}$			1.0	mA
Logic Low-Level Input Current	$I_{IL}$	$V_{CC} = 5.5\text{ V}$ , $V_{IL} = 0.4\text{ V}$			-1.6	mA
Logic High-Level Input Current	$I_{IH}$	$V_{CC} = 5.5\text{ V}$ , $V_{IH} = 2.4\text{ V}$			+100	$\mu\text{A}$
Enable Low-Level Input Current	$I_{EL}$	$V_{CC} = 5.5\text{ V}$ , $V_{EL} = 0.4\text{ V}$			-1.6	mA
Enable High-Level Input Current	$I_{EH}$	$V_{CC} = 5.5\text{ V}$ , $V_{EH} = 2.4\text{ V}$			+130	$\mu\text{A}$
Peak Wavelength	$\lambda_{PEAK}$	$T_A = 25^\circ\text{C}$		655		nm
Dominant Wavelength <sup>[8]</sup>	$\lambda_d$	$T_A = 25^\circ\text{C}$		640		nm
Weight**				1.0		gm
Leak Rate					$5 \times 10^{-8}$	cc/sec

**Notes:**

- Nominal thermal resistance of a display mounted in a socket which is soldered into a printed circuit board:  
 $\Theta_{JA} = 50^\circ\text{C/W}$ ;  $\Theta_{JC} = 15^\circ\text{C/W}$ .
- $\Theta_{CA}$  of a mounted display should not exceed  $35^\circ\text{C/W}$  for operation up to  $T_A = +100^\circ\text{C}$ .
- Voltage values are with respect to device ground, pin 6.
- All typical values at  $V_{CC} = 5.0\text{ Volts}$ ,  $T_A = 25^\circ\text{C}$ .
- These displays are categorized for luminous intensity with the intensity category designated by a letter located on the back of the display contiguous with the Hewlett-Packard logo marking.
- The luminous intensity at a specific ambient temperature,  $I_v(T_A)$ , may be calculated from this relationship:  
 $I_v(T_A) = I_v(25^\circ\text{C})(0.985)^{(T_A - 25^\circ\text{C})}$ .
- Applies only to 4N54.
- The dominant wavelength,  $\lambda_d$ , is derived from the CIE chromaticity diagram and represents the single wavelength which defines the color of the device.

\*JEDEC Registered Data.

\*\*Non-Registered Data.

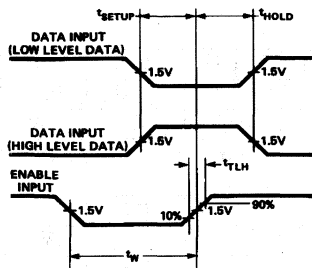

Figure 1. Timing Diagram of 4N51-4N54 Series Logic.

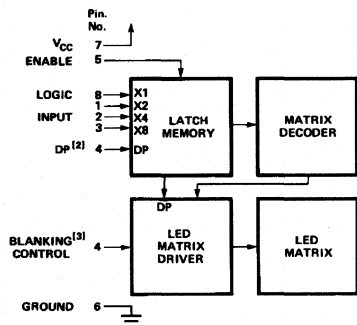

Figure 2. Block Diagram of 4N51-4N54 Series Logic.

BCD DATA <sup>[1]</sup>				TRUTH TABLE	
X <sub>3</sub>	X <sub>4</sub>	X <sub>2</sub>	X <sub>1</sub>	4N51 AND 4N52	4N54
L	L	L	L	0	0
L	L	L	H	1	1
L	L	H	L	2	2
L	L	H	H	3	3
L	H	L	L	4	4
L	H	L	H	5	5
L	H	H	L	6	6
L	H	H	H	7	7
H	L	L	L	8	8
H	L	L	H	9	9
H	L	H	L	A	A
H	L	H	H	(BLANK)	B
H	H	L	L	(BLANK)	C
H	H	L	H	...	D
H	H	H	L	(BLANK)	E
H	H	H	H	(BLANK)	F
DECIMAL PT. <sup>[2]</sup>				ON	V <sub>DP</sub> = L
				OFF	V <sub>DP</sub> = H
ENABLE <sup>[1]</sup>				LOAD DATA	V <sub>E</sub> = L
				LATCH DATA	V <sub>E</sub> = H
BLANKING <sup>[3]</sup>				DISPLAY-ON	V <sub>B</sub> = L
				DISPLAY-OFF	V <sub>B</sub> = H

Notes:

1. H = Logic High; L = Logic Low. With the enable input at logic high changes in BCD input logic levels or D.P. input have no effect upon display memory, displayed character, or D.P.
2. The decimal point input, DP, pertains only to the 4N51 and 4N52 displays.
3. The blanking control input, B, pertains only to the 4N54 hexadecimal display. Blanking input has no effect upon display memory.

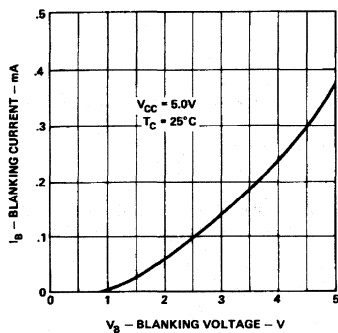

Figure 3. Typical Blanking Control Current vs. Voltage for 4N54.

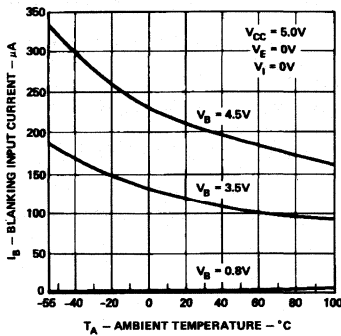

Figure 4. Typical Blanking Control Input Current vs. Ambient Temperature for 4N54.

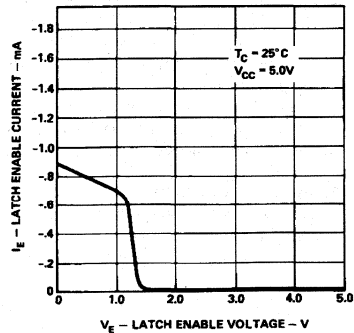

Figure 5. Typical Latch Enable Input Current vs. Voltage.



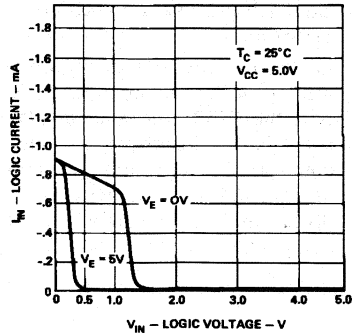

Figure 6. Typical Logic and Decimal Point Input Current vs. Voltage.

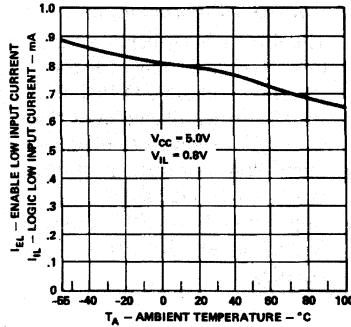

Figure 7. Typical Logic and Enable Low Input Current vs. Ambient Temperature.

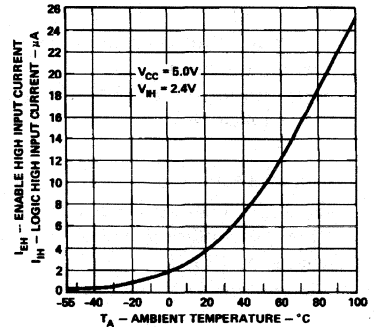

Figure 8. Typical Logic and Enable High Input Current vs. Ambient Temperature.

## Operational Considerations

### Electrical

The 4N51-4N54 series devices use a modified 4 x 7 dot matrix of light emitting diodes (LEDs) to display decimal/hexadecimal numeric information. The LEDs are driven by constant current drivers. BCD information is accepted by the display memory when the enable line is at logic low and the data is latched when the enable is at logic high. To avoid the latching of erroneous information, the enable pulse rise time should not exceed 200 nanoseconds. Using the enable pulse width and data setup and hold times listed in the Recommended Operating Conditions allows data to be clocked into an array of displays at a 6.7 MHz rate.

The blanking control input on the 4N54 display blanks (turns off) the displayed hexadecimal information without disturbing the contents of display memory. The display is blanked at a

minimum threshold level of 3.5 volts. This may be easily achieved by using an open collector TTL gate and a pull-up resistor. For example, (1/6) 7416 hexinverter buffer/driver and a 120 ohm pull-up resistor will provide sufficient drive to blank eight displays. The size of the blanking pull-up resistor may be calculated from the following formula, where N is the number of digits:

$$R_{\text{blank}} = (V_{\text{CC}} - 3.5 \text{ V}) / [N (1.0 \text{ mA})]$$

The decimal point input is active low true and this data is latched into the display memory in the same fashion as the BCD data. The decimal point LED is driven by the on-board IC.

The ESD susceptibility of the IC devices is Class A of MIL-STD-883 or Class 2 of DOD-STD-1686 and DOD-HDBK-263.

### Mechanical

4N51-4N54 series displays are hermetically tested for use in environments which require a

high reliability device. These displays are designed and tested to meet a helium leak rate of  $5 \times 10^{-8}$  cc/sec and a fluorocarbon gross leak bubble test.

These displays may be mounted by soldering directly to a printed circuit board or inserted into a socket. The lead-to-lead pin spacing is 2.54 mm (0.100 inch) and the lead row spacing is 15.24 mm (0.600 inch). These displays may be end stacked with 2.54 mm (0.100 inch) spacing between outside pins of adjacent displays. Sockets such as Augat 324 AG2D (3 digits) or Augat 508 (one digit, right angle mounting) may be used.

The primary thermal path for power dissipation is through the device leads. Therefore, to insure reliable operation up to an ambient temperature of +100°C, it is important to maintain a case-to-ambient thermal resistance of less than 35°C/watt as measured on top of display pin 3.

### Soldering

For information on soldering and post solder cleaning, see Application Note 1027 *Soldering LED Components*.

### Preconditioning

4N51-4N54 series displays are 100% preconditioned by 24 hour storage at 125°C.

### Contrast Enhancement

The 4N51-4N54 displays have been designed to provide the maximum possible ON/OFF contrast when placed behind an appropriate contrast enhancement filter. For further information see Hewlett-Packard Application Note 1015, *Contrast Enhancement for LED Displays*.

### Solid State Over Range Display

For display applications requiring a ±, 1, or decimal point designation, the 4N53 over range display is available. This display module comes in the same package as the 4N51-4N54 series numeric display and is completely compatible with it.

### Package Dimensions\*

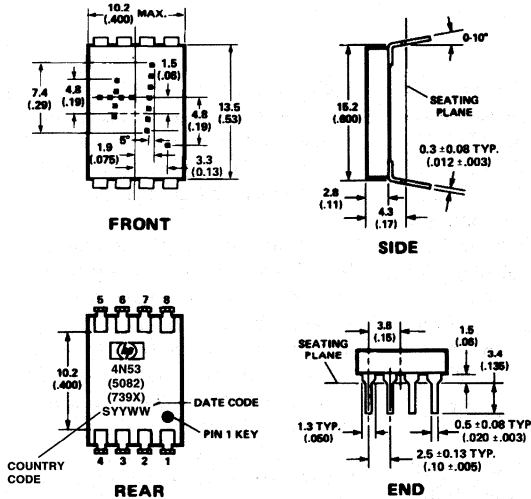

- NOTES:  
 1. DIMENSIONS IN MILLIMETRES AND (INCHES).  
 2. UNLESS OTHERWISE SPECIFIED, THE TOLERANCE ON ALL DIMENSIONS IS ±.38 MM (±.015 INCHES).

PIN	FUNCTION
1	Plus
2	Numeral One
3	Numeral One
4	DP
5	Open
6	Open
7	V <sub>CC</sub>
8	Minus/Plus

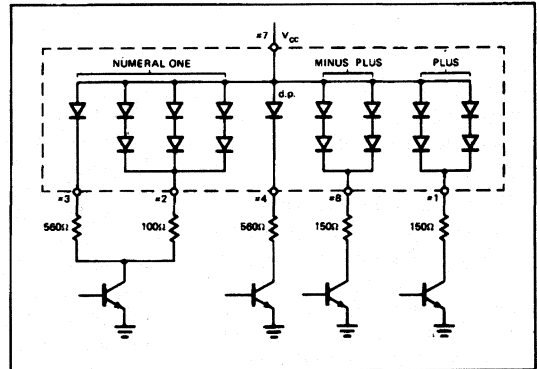

Figure 9. Typical Driving Circuit.

### TRUTH TABLE

CHARACTER	PIN			
	1	2,3	4	8
+	H	X	X	H
-	L	X	X	H
1	X	H	X	X
Decimal Point	X	X	H	X
Blank	L	L	L	L

- NOTES: L: Line switching transistor in Figure 9 cutoff.  
 H: Line switching transistor in Figure 9 saturated.  
 X: 'Don't care'

\*JEDEC registered data

## Electrical/Optical Characteristics\*

4N53 ( $T_A = -55^\circ\text{C}$  to  $+100^\circ\text{C}$ , Unless Otherwise Specified)

Description	Symbol	Test Conditions	Min	Typ	Max	Unit
Forward Voltage per LED	$V_F$	$I_F = 10\text{ mA}$		1.6	2.0	V
Power Dissipation	$P_T$	$I_F = 10\text{ mA}$ , all diodes lit		280	320	mW
Luminous Intensity per LED (Digit Average)	$I_F$	$I_F = 6\text{ mA}$ $T_C = 25^\circ\text{C}$	40	85		$\mu\text{cd}$
Peak Wavelength	$\lambda_{\text{peak}}$	$T_C = 25^\circ\text{C}$		655		nm
Dominant Wavelength	$\lambda_d$	$T_C = 25^\circ\text{C}$		640		nm
Weight**				1.0		gm

## Recommended Operating Conditions\*

Description	Sym	Min	Nom	Max	Unit
LED Supply Voltage	$V_{CC}$	4.5	5.0	5.5	V
Forward Current, Each LED	$I_F$		5.0	10	mA

## Absolute Maximum Ratings\*

Description	Symbol	Min	Max	Unit
Storage Temperature, Ambient	$T_S$	-65	+125	$^\circ\text{C}$
Operating Temperature, Ambient	$T_A$	-55	+100	$^\circ\text{C}$
Forward Current, Each LED	$I_F$		10	mA
Reverse Voltage, Each LED	$V_R$		4	V

### Note:

LED current must be externally limited. Refer to Figure 9 for recommended resistor values.

\*JEDEC Registered Data.

\*\*Non-Registered Data.

# Glass/Ceramic Numeric and Hexadecimal Displays for Industrial Applications

## Technical Data

**HDSP-078X**  
**HDSP-079X**  
**HDSP-088X**  
**HDSP-098X**

### Features

- **Three Character Options**  
 Numeric, Hexadecimal, Over Range
- **Three Colors**  
 High Efficiency Red, Yellow, High Performance Green
- **4 x 7 Dot Matrix Character**
- **High Efficiency Red, Yellow and High Performance Green**
- **Two High Efficiency Red Options**  
 Low Power, High Brightness
- **Performance Guaranteed Over Temperature**
- **High Temperature Stabilized**
- **Memory Latch/Decoder/Driver**  
 TTL Compatible

- **Categorized for Luminous Intensity**

### Description

These standard solid state displays have a 7.4 mm (0.29 inch) dot matrix character and an on-board IC with data memory latch/decoder and LED drivers in a glass/ceramic package.

The hermetic HDSP-078X,-079X/-088X displays utilize a solder glass frit seal. The HDSP-098X displays utilize an epoxy glass-to-ceramic seal.

The numeric devices decode positive BCD logic into characters "0-9," a "-" sign, decimal point, and a test pattern. The hexadecimal devices decode

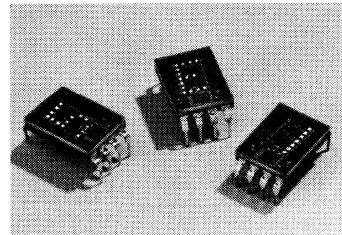

positive BCD logic into 16 characters, "0-9, A-F." An input is provided on the hexadecimal devices to blank the display (all LEDS off) without losing the contents of the memory.

The over range device displays "± 1" and right hand decimal point and is typically driven via external switching transistors.

### Devices

Part Number HDSP-	Color	Description	Front View
0781	High-Efficiency Red Low Power	Numeric, Right Hand DP	A
0782		Numeric, Left Hand DP	B
0783		Over Range ± 1	C
0784		Hexadecimal	D
0791	High-Efficiency Red High Brightness	Numeric, Right Hand DP	A
0792		Numeric, Left Hand DP	B
0793		Over Range ± 1	C
0794		Hexadecimal	D
0881	Yellow	Numeric, Right Hand DP	A
0882		Numeric, Left Hand DP	B
0883		Over Range ± 1	C
0884		Hexadecimal	D
0981	High-Performance Green	Numeric, Right Hand DP	A
0982		Numeric, Left Hand DP	B
0983		Over Range ± 1	C
0984		Hexadecimal	D

# Package Dimensions

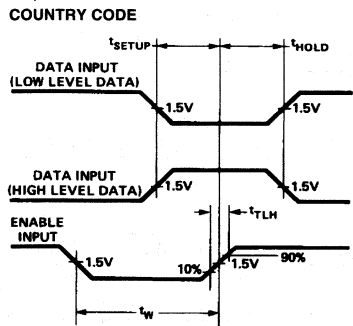
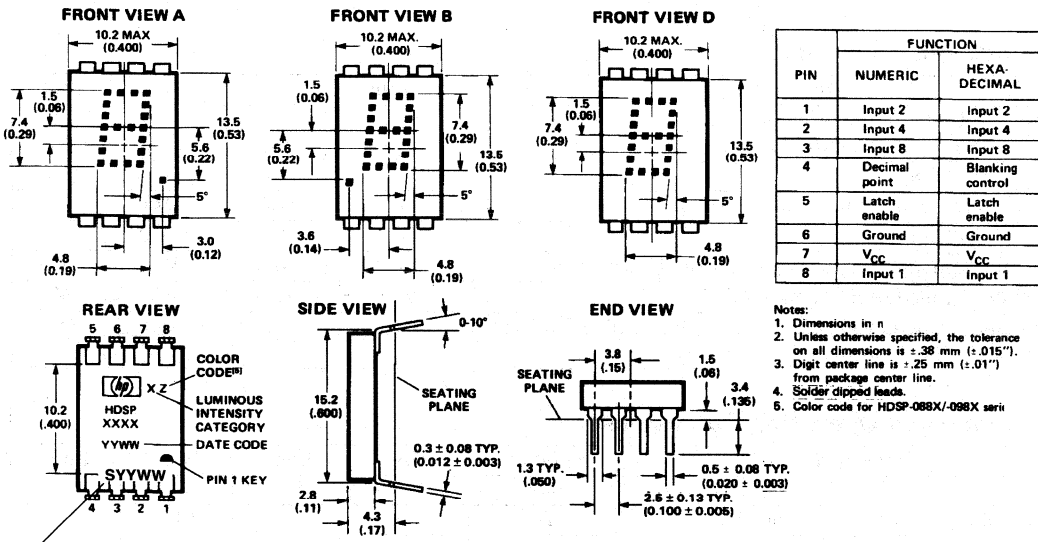

Figure 1. Timing Diagram.

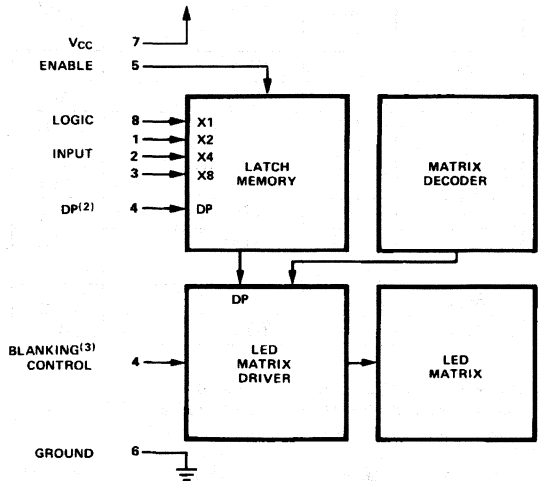

Figure 2. Block Diagram.

BCD DATA <sup>(1)</sup>				NUMERIC	HEXA-DECIMAL
X <sub>8</sub>	X <sub>4</sub>	X <sub>2</sub>	X <sub>1</sub>		
L	L	L	L	0	0
L	L	L	H	1	1
L	L	H	L	2	2
L	L	H	H	3	3
L	H	L	L	4	4
L	H	L	H	5	5
L	H	H	L	6	6
L	H	H	H	7	7
H	L	L	L	8	8
H	L	L	H	9	9
H	L	H	L	(BLANK)	A
H	L	H	H	(BLANK)	B
H	H	L	L	(BLANK)	C
H	H	L	H	(BLANK)	D
H	H	H	L	(BLANK)	E
H	H	H	H	(BLANK)	F
DECIMAL PT. <sup>(2)</sup>				ON	V <sub>DP</sub> = L
				OFF	V <sub>DP</sub> = H
ENABLE <sup>(1)</sup>				LOAD DATA	V <sub>E</sub> = L
				LATCH DATA	V <sub>E</sub> = H
BLANKING <sup>(3)</sup>				DISPLAY ON	V <sub>B</sub> = L
				DISPLAY OFF	V <sub>B</sub> = H

**Notes:**  
 1. H = Logic High; L = Logic Low. With the enable input at logic high changes in BCD input logic levels have no effect upon display memory, displayed character, or DP.  
 2. The decimal point input, DP, pertains only to the numeric displays.  
 3. The blanking control input, B, pertains only to the hexadecimal displays. Blanking input has no effect upon display memory.

GLASS/CERAMIC DISPLAYS

## Absolute Maximum Ratings

Description	Symbol	Min.	Max.	Unit
Storage Temperature, Ambient HDSP-078X/-079X/-088X	$T_S$	-65	+125	°C
HDSP-098X		-55	+100	
Operating Temperature, Ambient <sup>[1]</sup>	$T_A$	-55	+100	°C
Supply Voltage <sup>[2]</sup>	$V_{CC}$	-0.5	+7.0	V
Voltage Applied to Input Logic, dp and Enable Pins	$V_I, V_{DP}, V_E$	-0.5	$V_{CC}$	V
Voltage Applied to Blanking Input <sup>[2]</sup>	$V_R$	-0.5	$V_{CC}$	V
Maximum Solder Temperature at 1.59 mm (0.062 inch) Below Seating Plane; $t \leq 5$ Seconds			260	°C

## Recommended Operating Conditions

Description	Symbol	Min.	Nom.	Max.	Unit
Supply Voltage <sup>[2]</sup>	$V_{CC}$	4.5	5.0	5.5	V
Operating Temperature, Ambient <sup>[1]</sup>	$T_A$	-55		+100	°C
Enable Pulse Width	$t_W$	100			nsec
Time Data Must Be Held Before Positive Transition of Enable Line	$t_{SETUP}$	50			nsec
Time Data Must Be Held After Positive Transition of Enable Line	$t_{HOLD}$	50			nsec
Enable Pulse Rise Time	$t_{TLH}$			1.0	msec

## Optical Characteristics at $T_A = 25^\circ\text{C}$ , $V_{CC} = 5.0\text{ V}$

Device	Description	Symbol	Min.	Typ.	Max.	Unit
HDSP-078X Series	Luminous Intensity per LED (Digit Average) <sup>[3,4]</sup>	$I_V$	65	140		$\mu\text{cd}$
	Peak Wavelength	$\lambda_{PEAK}$		635		nm
	Dominant Wavelength <sup>[5]</sup>	$\lambda_d$		626		nm
HDSP-079X Series	Luminous Intensity per LED (Digit Average) <sup>[3,4]</sup>	$I_V$	260	620		$\mu\text{cd}$
	Peak Wavelength	$\lambda_{PEAK}$		635		nm
	Dominant Wavelength <sup>[5]</sup>	$\lambda_d$		626		nm
HDSP-088X Series	Luminous Intensity per LED (Digit Average) <sup>[3,4]</sup>	$I_V$	215	490		$\mu\text{cd}$
	Peak Wavelength	$\lambda_{PEAK}$		583		nm
	Dominant Wavelength <sup>[5,6]</sup>	$\lambda_d$		585		nm
HDSP-098X Series	Luminous Intensity per LED (Digit Average) <sup>[3,4]</sup>	$I_V$	298	1100		$\mu\text{cd}$
	Peak Wavelength	$\lambda_{PEAK}$		568		nm
	Dominant Wavelength	$\lambda_d$		574		nm

### Notes:

- The nominal thermal resistance of a display mounted in a socket that is soldered onto a printed circuit board is  $R_{\theta_{JA}} = 50^\circ\text{C/W/device}$ . The device package thermal resistance is  $R_{\theta_{J-PIN}} = 15^\circ\text{C/W/device}$ . The thermal resistance device pin-to-ambient through the PC board should not exceed  $35^\circ\text{C/W/device}$  for operation up to  $T_A = +100^\circ\text{C}$ .
- Voltage values are with respect to device ground, pin 6.
- These displays are categorized for luminous intensity with the intensity category designated by a letter code located on the back of the display package. Case temperature of the device immediately prior to the light measurement is equal to  $25^\circ\text{C}$ .

## Electrical/Optical Characteristics

$T_A = -55^\circ\text{C}$  to  $+100^\circ\text{C}$

Description	Symbol	Test Conditions	Min.	Typ. <sup>[7]</sup>	Max.	Unit
Supply Current	I <sub>CC</sub>	V <sub>CC</sub> = 5.5 V Characters "5." or "B" displayed		78	105	mA
				120	175	
Power Dissipation	P <sub>T</sub>	V <sub>CC</sub> = 5.5 V Characters "5." or "B" displayed		390	573	mW
				690	963	
Logic, Enable and Blanking Low-Level Input Voltage	V <sub>IL</sub>	V <sub>CC</sub> = 4.5 V			0.8	V
Logic, Enable High-Level Input Voltage	V <sub>IH</sub>		2.0			V
Blanking High-Voltage; Display Blanked	V <sub>BH</sub>		2.3			V
Logic and Enable Low-Level Input Current	I <sub>IL</sub>	V <sub>CC</sub> = 5.5 V			-1.6	mA
Blanking Low-Level Input Current	I <sub>BL</sub>	V <sub>IL</sub> = 0.4 V			-10	μA
Logic, Enable and Blanking High-Level Input Current	I <sub>IH</sub>	V <sub>CC</sub> = 5.5 V V <sub>IH</sub> = 2.4 V			+40	μA
Weight				1.0		gm
Leak Rate					5 x 10 <sup>-8</sup>	cc/sec

### Notes:

- The luminous intensity at a specific operating ambient temperature,  $I_v(T_A)$ , may be approximated from the following exponential equation:  $I_v(T_A) = I_v(25^\circ\text{C}) e^{[k(T_A - 25^\circ\text{C})]}$ .
- The dominant wavelength,  $\lambda_d$ , is derived from the CIE chromaticity diagram and represents the single wavelength which defines the color of the device.
- The HDSP-088X and HDSP-098X series devices are categorized as to dominant wavelength with the category designated by a number on the back of the display package.
- All typical values at V<sub>CC</sub> = 5.0 V and T<sub>A</sub> = 25°C.

Device	K
HDSP-078X Series HDSP-079X Series	-0.0131/°C
HDSP-088X Series	-0.0112/°C
HDSP-098X Series	-0.0104/°C

## Operational Considerations

### Electrical

These devices use a modified 4 x 7 dot matrix of light emitting diodes to display decimal/hexadecimal numeric information. The high efficiency red and yellow displays use GaAsP/GaP LEDs and the high performance green displays use GaP/GaP LEDs. The LEDs are driven by constant current drivers, BCD information is accepted by the display memory when the enable

line is at logic low and the data is latched when the enable is at logic high. Using the enable pulse width and data setup and hold times listed in the Recommended Operating Conditions allows data to be clocked into an array of displays at a 6.7 MHz rate.

The decimal point input is active low true and this data is latched into the display memory in the same fashion as the BCD data. The decimal point LED is driven by the on-board IC.

The blanking control input on the hexadecimal displays blanks (turns off) the displayed information without disturbing the contents of display memory. The display is blanked at a minimum threshold level of 2.0 volts. When blanked, the display standby power is nominally 250 mW at T<sub>A</sub> = 25°C.

The ESD susceptibility of the IC devices is Class A of MIL-STD-883 or Class 2 of DOD-STD-1686 and DOD-HDBK-263.

### Mechanical

These displays are hermetically sealed for use in environments that require a high reliability device. These displays are designed and tested to meet a helium leak rate of  $5 \times 10^{-8}$  cc/sec.

These displays may be mounted by soldering directly to a printed circuit board or insertion into a socket. The lead-to-lead pin spacing is 2.54 mm (0.100 inch) and the lead row spacing is 15.24 mm (0.600 inch). These displays may be end stacked with 2.54 mm (0.100 inch) spacing between outside pins of adjacent displays. Sockets such as Augat 324-AG2D (3 digits) or Augat

508-AG8D (one digit, right angle mounting) may be used.

The primary thermal path for power dissipation is through the device leads. Therefore, to insure reliable operation up to an ambient temperature of  $+100^{\circ}\text{C}$ , it is important to maintain a base-to-ambient thermal resistance of less than  $35^{\circ}\text{C watt/device}$  as measured on top of display pin 3.

For further information on soldering and post solder cleaning, see Application Note 1027, *Soldering LED Components*.

### Preconditioning

These displays are 100% preconditioned by 24 hour storage at  $125^{\circ}\text{C}$ , at  $100^{\circ}\text{C}$  for the HDSP-098X Series.

### Contrast Enhancement

These display devices are designed to provide an optimum ON/OFF contrast when placed behind an appropriate contrast enhancement filter. For further information on contrast enhancement, see Application Note 1015, *Contrast Enhancement for LED Displays*.

### Over Range Display

The over range devices display " $\pm 1$ " and decimal point. The character height and package configuration are the same as the numeric and hexadecimal devices. Character selection is obtained via external switching transistors and current limiting resistors.

### Absolute Maximum Ratings

Description	Symbol	Min	Max	Unit
Storage Temperature, Ambient	$T_S$	-65	+125	$^{\circ}\text{C}$
Operating Temperature, Ambient	$T_A$	-55	+100	$^{\circ}\text{C}$
Forward Current, Each LED	$I_F$		10	mA
Reverse Voltage, Each LED	$V_R$		5	V



## Package Dimensions

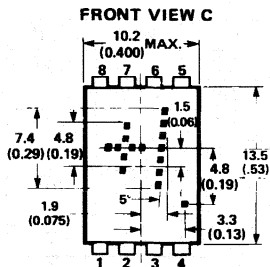

Pin	Function
1	Plus
2	Numeral One
3	Numeral One
4	DP.
5	Open
6	Open
7	V <sub>CC</sub>
8	Minus/Plus

Note:  
1. Dimensions in millimetres and (inches).

Character	Pin			
	1	2,3	4	8
+	1	X	X	1
-	0	X	X	1
1	X	1	X	X
Decimal Point	X	X	1	X
Blank	0	0	0	0

Notes:  
0: Line switching transistor in Figure 7 cutoff.  
1: Line switching transistor in Figure 7 saturated.  
X: 'don't care.'

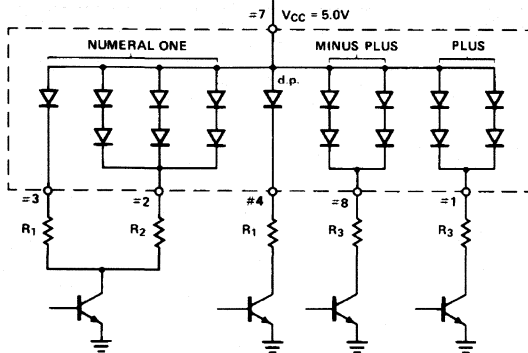

Figure 3. Typical Driving Circuit.

## Luminous Intensity per LED

(Digit Average) at T<sub>A</sub> = 25°C

Device	Test Conditions	Min.	Typ.	Units
HDSP-0783	I <sub>F</sub> = 2.8 mA	65	140	μcd
	I <sub>F</sub> = 8 mA		620	μcd
HDSP-0883	I <sub>F</sub> = 8 mA	215	490	μcd
HDSP-0983	I <sub>F</sub> = 8 mA	298	1100	μcd

## Recommended Operating Conditions

V<sub>CC</sub> = 5.0 V

Device	Forward Current Per LED, mA	Resistor Value			
		R <sub>1</sub>	R <sub>2</sub>	R <sub>3</sub>	
HDSP-0783	Low Power	2.8	1300	200	300
	High Brightness	8	360	47	68
HDSP-0883	8	360	36	56	
HDSP-0983	8	360	30	43	

GLASS/CERAMIC  
DISPLAYS

## Electrical Characteristics

$T_A = -55^\circ\text{C}$  to  $+100^\circ\text{C}$

Device	Description	Symbol	Test Conditions	Min	Typ	Max	Unit
HDSP-0783	Power Dissipation (All LEDs Illuminated)	$P_T$	$I_F = 2.8 \text{ mA}$		72		mW
			$I_F = 8 \text{ mA}$		224	282	
	Forward Voltage per LED	$V_F$	$I_F = 2.8 \text{ mA}$		1.6		V
			$I_F = 8 \text{ mA}$		1.75	2.2	
HDSP-0883	Power Dissipation (All LEDs Illuminated)	$P_T$	$I_F = 8 \text{ mA}$		237	282	mW
	Forward Voltage per LED	$V_F$			1.90	2.2	V
HDSP-0883	Power Dissipation (All LEDs Illuminated)	$P_T$	$I_F = 8 \text{ mA}$		243	282	mW
	Forward Voltage per LED	$V_F$			1.85	2.2	V

# Infrared Products

- IrDA Transceivers
- Emitters
- Detectors
- Integrated Circuits

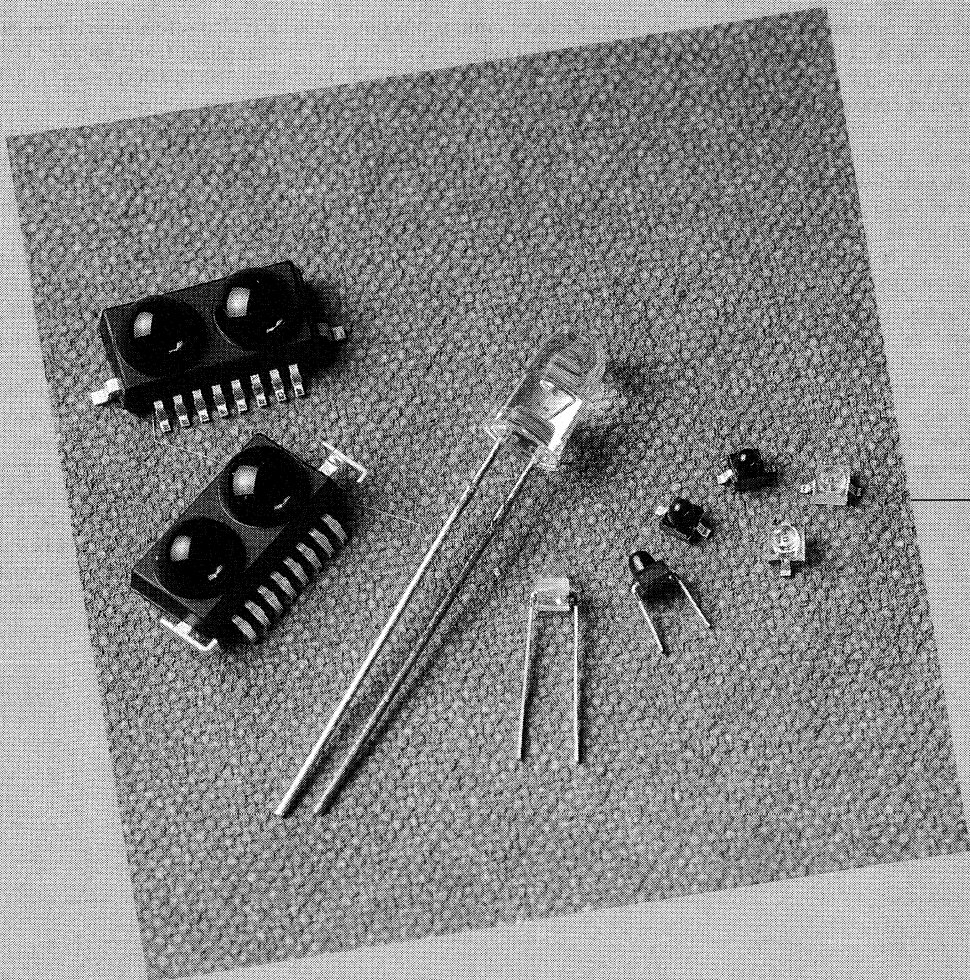

---

## Infrared Products

Infrared communications technology is quickly becoming a de facto feature of computer/office and communications products. In the future, this communications technology will be key in industrial and medical handheld equipment as well as transportation and consumer products. HP has been in the forefront of IR technology combining superior III/V LED technology, high performance, high speed analog IC devices, and high volume manufacturing processes to produce infrared emitters, detectors, and transceiver modules.

HP's discrete emitter offering includes two versions of a T-1 $\frac{3}{4}$  (5 mm) TS AlGaAs 875 nm LED lamp and two versions of an SMT subminiature 875 TS AlGaAs LED lamp. The HSDL-4220 is a 38 mW/Sr, 30° T-1 $\frac{3}{4}$  lamp and the HSDL-4230 is a 75 mW/Sr, 17° T-1 $\frac{3}{4}$  lamp. The HSDL-4400 is a series of flat top subminiature LED lamps and the HSDL-4420 is a series of dome top subminiature LED lamps. Under development is a series of IR detectors. The HSDL-5400 is a series of flat top subminiature LED detectors and the HSDL-5420 is a series of dome top subminiature LED detectors.

---

HP also offers a series of IrDA compliant transceiver modules. The HSDL-1000 is a 115.2 Kb/s, 1 meter minimum distance transceiver module designed to IrDA physical layer specifications. The HSDL-1001 is an IrDA 115.2 Kb/s module with improved electrical performance. This product is designed for low power, fast link turn around applications. This device also offers a shutdown feature for true power saving. This device will be released by July 1996. The HSDL-1100, a faster speed IrDA 4.0 Mb/s transceiver is under development and will be product released in May 1996. Also under development is a smaller form factor transceiver package for both the 115.2 Kb/s and the 4.0 Mb/s products. These products will be available in late 1996.

**IrDA Infrared Transceivers**

Part Number	Data Rate Range	Distance Range	Supply Voltage	Idle Current	Shut-down Pin	Receiver Latency	Operating Temperature	Package Size (w x h)	Mounting Options	Applications	Page No.
HSDL-1000 <i>New!</i>	9.6 K-115.2 K	0 to 1	5	1.1	No	8	0 to 70	15 x 8.75	top/right angle	Notebook/Desktop PCs, FAX, modems PDAs,	4-33
HSDL-1001 <i>New!</i>	9.6 K-115.2 K	0 to 1	3 to 5	0.17	Yes	0.1	0 to 70	15 x 8.75	top/right angle	mobile/fixed phones, automotive, handheld instruments	4-53
HSDL-1100 <i>New!</i>	9.6 K-4.0 M	0 to 1	5		No	0.2	0 to 70	15 x 8.75	top/right angle	Notebook/Desktop PCs, printers, scanners, digital cameras	4-61
Units	Baud	m	V	mA		ms	C	mm			

**Infrared Emitters**

Part Number	Package Size	Viewing Angle	On Axis Intensity	Forward Voltage	Rise/Fall Time	Operating Temperature	Mounting Options	Applications	Page No.
HSDL-4220 <i>New!</i>	T-1 <sup>3</sup> / <sub>4</sub> (5)	30	22	1.50	40	0 to 70	top, right angle	Extended distance to IrDA Ir transceivers, consumer audio/video, automotive industrial handhelds, diffuse IR networks, control, and sensor	4-48
HSDL-4230 <i>New!</i>	T-1 <sup>3</sup> / <sub>4</sub> (5)	17	39	1.50	40	0 to 70	top, right angle		
HSDL-4400 <i>New!</i>	Sub-miniature (2x2)	110	4	1.50	40	-40 to 85	SMT top & reverse, thru-hole	Short range IR data links, small handheld, pagers, PCMCIA cards, diagnostics/programming, board-to-board, smart cards and sensor	4-68
HSDL-4420 <i>New!</i>	Sub-miniature (2x2)	24	18	1.50	40	-40 to 85	SMT top & reverse, thru-hole		
Units	(mm)	degrees	mW/sr	V	ns	C			

**Note:**

1. Where applicable forward current is 50 mA.

**Infrared Detectors**

Part Number	Package Size	Viewing Angle	Photo Current @ 875 nm	Dark Current	Rise/Fall Time	Operating Temperature	Mounting Options	Application	Page No.
HSDL-5400 <i>New!</i>	Sub-miniature	110	1.6	2	7.5	-40 to 85	Same as HSDL-4400/4420	Same as Infrared Emitter HSDL-4400/4420	4-68
HSDL-5420 <i>New!</i>	Sub-miniature	28	6.0	2	7.5	-40 to 85	Same as HSDL-4400/4420		
Units		degrees	μA	nA	ns	C			

**Note:**

2. Where applicable forward current is 1 mW/cm<sup>2</sup>.

**Infrared ICs**

Part Number	Description	Interface to	Operating Temperature	Package	Page No.
HSDL-7000 <i>New!</i>	IrDA 3/16th Modulation IC	HSDL-1000 or HSDL-1001	-10 to 85	8 Pin SMT	4-43
Units			C		

**Evaluation Kits**

Part Number	Description	Contents
HSDL-8000 <i>New!</i>	IrDA 115.2 Kbps Evaluation Kit	Contains 2 fully functional PCBs with HSDL-1000 and HSDL-7000. HSDL-4220 and HSDL-4230 are provided for extended distance applications. Literature-IrDA Design Guide

INFRARED PRODUCTS

---

## IrDA Data Link Design Guide

---

### HP SIR History

Hewlett-Packard has been offering infrared data transfer in its products beginning with the infrared printer port of the HP-41C pocket calculator introduced in 1979. In 1990, HP introduced the HP-48SX calculator, a bi-directional IR port. Finally, with HP's OmniBook 300 sub-notebook and 100LX palmtop computers, introduced in 1992, and the Vectra XM series desktop computers, introduced in May, 1993, HP began to offer a serial infrared port using HP's 115.2 Kb/s Serial Infrared (HP SIR) standard.

Seeing the benefits of an open infrared standard which could allow cableless communication between a variety of devices from many manufacturers, HP was instrumental in the formation of the Infrared Data Association. In September of 1993, HP SIR was adopted by IrDA as its hardware, physical layer standard, and added IrLAP; the link access protocol layer and IrLMP; the link management layer. In addition optional transport protocol layers are also written and are available. IrDA, at that time, was an organization of 40 members. The IrDA standard was designed around a "point and shoot" environment for short distance, 1m, tetherless communication featuring data

integrity, reliability, and low cost. HP began an HP SIR licensing program in 1993 which made the technology available to the public. IrDA has since grown into an organization of over 100 members, representing companies spanning computer and office automation, telecommunications, consumer, automotive, and industrial markets, with representation from around the world. By November, 1994, there were at least four companies demonstrating notebook computers equipped with IrDA-compatible IR ports, three companies demonstrating desktop PCs, one company incorporating an IR port into laser printers, and a company offering an IrDA-compatible adapter for the serial ports of existing PCs. Since then other companies have introduced portable computers with an IrDA-compatible port, and other companies offer adapters for existing printers.

Microsoft supports infrared connectivity in the Messaging Applications Program Interface (MAPI) and Telephony API (TAPI) in Windows 95, and Microsoft WinPad-based PDAs incorporating IrDA compatible IR ports are scheduled for introduction in 1995.

The advantages of this inexpensive and truly portable connectivity is being viewed with great

interest by medical, test and measurement, automotive, transportation and networking companies who have seen the early success of the subnotebook computer and printer users. Designs on the drawing board include drive-through toll booth payment equipment, automotive diagnostic data transfer and keyless entry systems, and at least one national telephone company has outlined plans to incorporate IR ports into hotel and public phones.

In April of 1995, IrDA approved a faster speed standard by voting into place the joint HP, IBM and Sharp proposal for a link which will run at 4 Mb/s, 1.15 Mb/s and be backward compatible to the present 115.2 Kb/s. Transfer of text files and relatively small amounts of information between machines is the primary application with the present 115.2 Kb/products. The release of 4 MB/s and 1.15 Mb/s standard will allow users to move into more data intensive applications such as networking, and the transfer of larger amounts of data that include color graphic files to printers. 10 Mb/s and faster are on the horizon and lead to the possibilities of IR docking stations, multimedia in computing products and very fast data transfer with imaging products. IR is also used in security,

industrial and automotive applications requiring motion sensing or transmission of short packets of data such as in keyless entry. The development of faster, low power IR components will allow more data to be sent over longer distances in products providing much longer battery life than at present. Small form factor, inexpensive devices will allow IR ports to be included in a wide variety of products for such functions as on-line testing, diagnostics, remote programming and other applications, doing away with the need for plugs, connectors and wires which are presently used in such applications.

### **HP Components Group**

HP's Components Group is the largest independent supplier of communications components in the world. The group's charter—to develop semiconductor component solutions that enable the information exchange revolution—advances such strategic technologies as the “information superhighway,” the extended desktop and mobile information appliances. These technologies will significantly expand communications and information management capabilities worldwide.

The Components Group, founded more than 30 years ago and headquartered in San Jose, California, employs 8925 people worldwide, and includes three major divisions—the Communication Components, Optical Communication and Optoelectronics Divisions. The HP Components Group serves six major markets: communications, computer/office, industrial,

transportation, consumer and government/military.

### Major Product Areas:

- Fiber-optic components for voice, data and video transmission
- Fiber-optic link products for computer data transfer
- Radio frequency (RF) and microwave components for wireless communications
- RF and microwave transistors and integrated circuits for wireless communications
- Light-emitting diode (LED) displays
- LED indicators
- LED high-brightness lamps
- Motion-control products for instruments, industrial equipment, office equipment and printers
- Optocouplers for industrial equipment and motor control
- Bar-code scanners
- RF and microwave amplifiers for wireless communications
- Infrared emitters, detectors and transceiver modules for the communications and computer/office markets

### Current Leadership Positions:

- #1 worldwide in LED lamps and displays
- World's brightest LEDs
- #1 worldwide in fiber-optic communications transceiver modules
- Technical leader for visible III-V products
- World's broadest fiber optic components product line
- #1 worldwide in optical encoders
- #1 worldwide in photo IC optocouplers
- World's most advanced high-speed silicon bipolar process

Recent advances in band gap engineering, coupled with expertise in optics design and high volume manufacturing have permitted HP to develop products such as the IrDA-compliant transceiver module. III-V advances will continue to focus on developing faster devices without compromising light output, reliability or cost. HP's experience with fiber optic transmitters and receivers as well as bar code scanners provides a wealth of knowledge about designing and manufacturing through-the-air data link solutions.

In addition to III-V materials capabilities, HP's access to high performance, high-speed analog bipolar IC processes is also very important to Components Group products. For example, the serial infrared module contains an IC containing high-sensitivity photo detectors and amplifiers combined with integral logic.

### *Emitter Technology*

Figures 1 and 2 provide a look at the III-V technology for IR emitters. The first two devices on the left represent a much older technology, primarily used for control and sensing applications. These devices are relatively bright, but too slow for data transmission.

The emitter technology on the right represents DH TS AlGaAs (Double Heterojunction Transparent Substrate Aluminum Gallium Arsenide ) emitter structure, the technology used in HP's IR transceiver. This technology is superior in optical power and speed, as shown in Figure 2. The TS AlGaAs emitters can be as much as three times as powerful

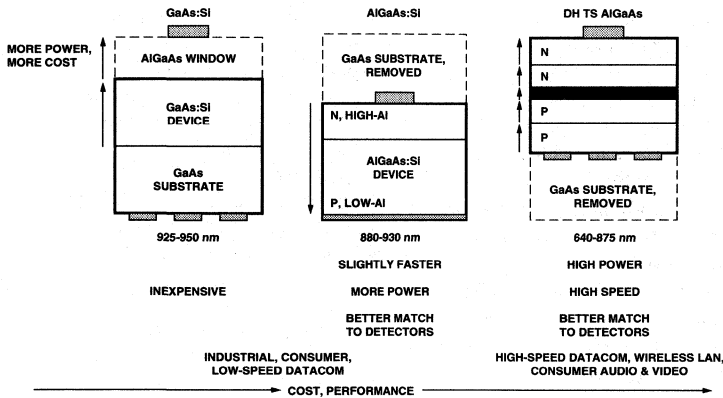

Figure 1, and 2. IR Emitter Technology.

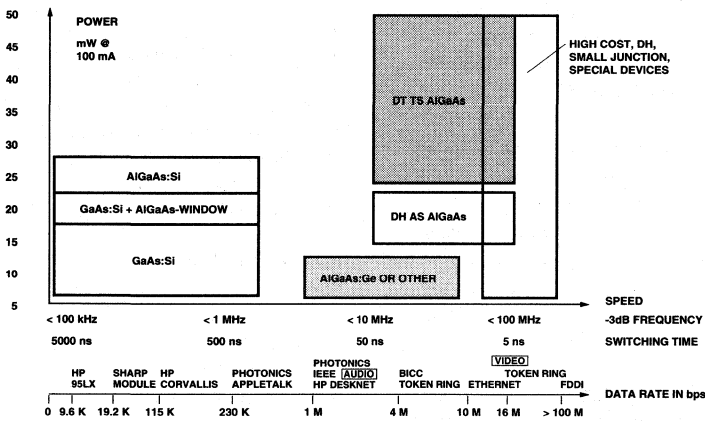

Figure 1, and 2. IR Emitter Technology.

and ten times faster than GaAs:Si and AlGaAs:Si. The keys to the efficiency of this die is in the band gap engineering which goes into optimizing the ability to generate and allow the light to escape from the junction in the middle of the die, and the removal of the GaAs substrate which acts as a light absorbing medium in earlier technology (absorbing substrate) die.

### Manufacturing

These products are assembled in highly-automated facilities with many years of experience in high volume manufacturing. In addition to their high volume manufacturing expertise, these facilities have been leaders in TQM for many years and are ISO 9000 certified. These policies and certification insure the best process control practices takes

place and the highest quality products are shipped.

### Future Product Direction

The major thrust of new IR data link products under development will be on increased data rate and efficiency. The III-V expertise will be leveraged to provide customers with the highest speed and efficiency products available at reasonable cost. Active development will also take place in increased integration and cost reduction in the module. HP Components Group is well positioned in these areas because of its in-house capabilities and large manufacturing facilities.

## Infrared Data Association (IrDA) Standard

### Background

IrDA is an independent organization whose charter is to create interoperable, low cost IR data interconnection standards that support a walk-up, point-to-point user model that is adaptable to a broad range of appliances, computing and communicating devices. The IrDA address and phone number is listed in the appendix under the reference list. Setting standards for IR communication is key to effortless communication between brands and types of equipment. Standards and protocols which can be reasonably and inexpensively implemented is key to promoting the proliferation of IR.



There are a few administrative items when getting involved with the IrDA.

**IrDA Membership Fees:**

\$3,000 (US) for affiliate membership (standards documents, attend meetings, access to reflector)

\$6,000 for executive membership (same as affiliate plus voting rights)

**IrDA Standards Document Fee:**

\$500 for Standards Document per company

**HP Patent Agreement**

As part of the HP SIR technology, HP had patented the encode/decode circuitry and IR receiver minus the PIN photodiode (Figure 3). Acquisition of a license to use the HP patent should be considered by component or subsystem manufacturers that provide components that infringes on the

patent. System manufacturers or OEMs that purchase and implement components utilizing the technology do not need to acquire an HP patent license. The system OEM is relieved of any license requirement as long as one of the components in the system is from a firm that acquired a valid HP License. The license fee is \$5000 and the licensing agent is IrDA. HP's patent only applies to the 115.2 Kb/s standard and license agreements are not required for any higher speed versions, such as the 1.15 Mb/s and 4 Mb/s standard.

**IrDA Standard**

The IrDA specifications provide guidelines for link access (IrLAP), link management (IrLMP), and for the physical transfer of data bits (Physical Layer Specification) (see Figure 4). IrLAP provides guidelines for the software which looks for other

machines to connect to (sniff), discovers other machines (discover), resolves addressing conflicts, initiates a connection, transfers data, and cleanly disconnects. IrLAP specifies the frame and byte structure of IR packets as well as the error detection methodology for IR communication. Figure 5 shows the block diagram of the IrDA IrLAP function. Within the link connection provided by IrLAP, the functions and applications are managed by IrLMP software. IrLMP assesses the equipment and services available on the connected pieces of equipment, and manages negotiation of parameters such as bit rate, number of BOFs (beginning of frame), and link turn around time. IrLMP then manages the correct transfer of data and information.

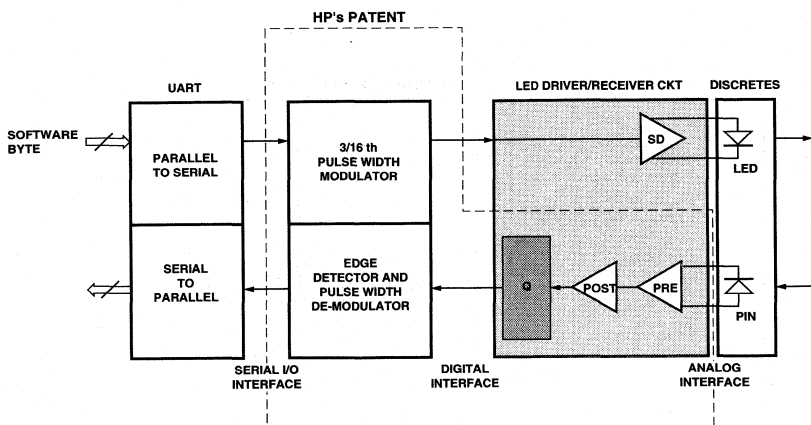

Figure 3. IrDA Physical Layer and HP Patent.

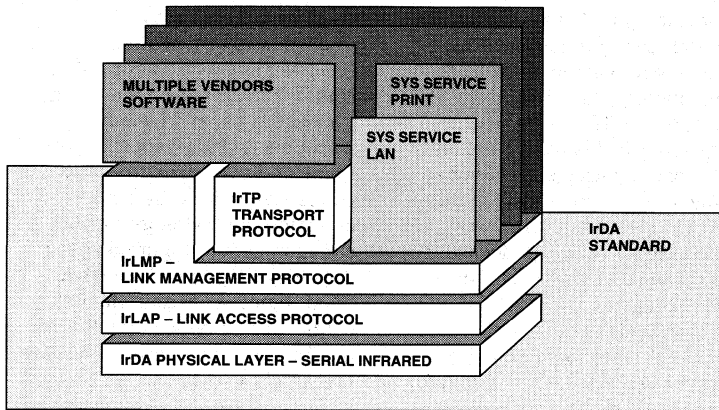

Figure 4. IrDA Protocol Stack.

### IrDA Physical Layer

The Physical Layer Specification provides guidelines for the physical connection of equipment using IR. The specifications for operating distance, viewing angle, optical power, data rate, and noise immunity enable physical interconnectivity between various brands and types of equipment. The specifications also ensure successful communication in typical environments and minimize interference between IR participants. The physical layer block diagram is shown in Figure 6 and represents the components necessary to implement an IrDA data link. Figures 7 and 8 describe the template for acceptable intensity/incidence versus viewing angle. These parameters as well as others are needed to ensure IrDA compliance at the physical layer.

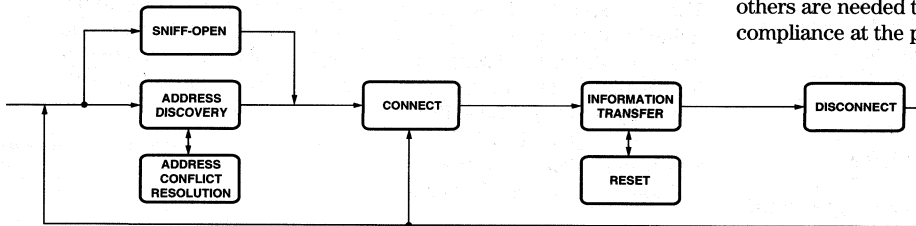

Figure 5. IrLAP Block Diagram.

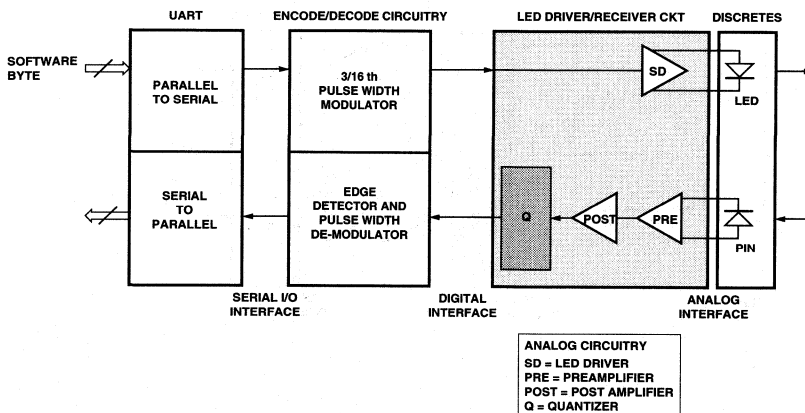

Figure 6. IrDA Physical Layer Block Diagram.

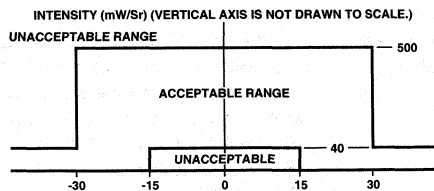

Figure 7. Acceptable Optical Output Intensity Range.

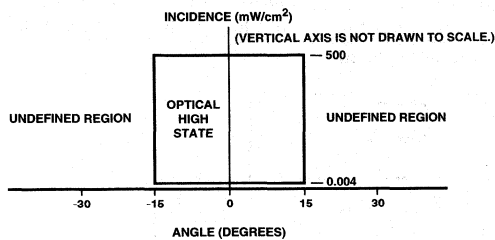

Figure 8. Optical High State Acceptable Range.

The IrDA physical layer specification defines the IR communication of a half-duplex link. Some of the key parameters are shown in the table below.

Link Parameters	Specifications
Communication	half-duplex
Operating Distance	0 to 1 m
Data Rate	9.6 to 115.2 Kb/s
Modulation	3/16
Bit Error Rate	$<10^{-9}$

Transmitter Parameters	Specification
Peak Wavelength	850 nm to 900 nm
On-axis Intensity	40 mW/sr to 500 mW/sr
Optical Half Angle Range	$\pm 15$ to $\pm 30$ degrees, see Figure 7
Pulse Rise/Fall Time	$< 600$ ns
Pulse Optical Overshoot	$< 25\%$
Systematic Jitter	$< 0.2 \mu$ s

Receiver Parameters	Specification
Incidence in Angular Range	$4 \mu$ W/cm <sup>2</sup> to 500 mW/cm <sup>2</sup> , see Figure 8
Half-Angle	$> \pm 15$ degrees
Systematic Jitter	$< 0.2$ ms
Latency	$< 10$ ms

The IrDA link is a half-duplex link because of the physical proximity of the optical components. The transmitter and receiver in a point and shoot model are physically close together. When the transmitter is emitting light it saturates its own receiver, thus disabling it from receiving data from another source. A certain amount of time must elapse before the receiver can operate. In this case,  $< 10$  ms is required for the receiver to return to its receiving state before the other end of the link starts to send data back. This delay, the period between the time that the transmitter stops sending light pulses and the time the receiver is able to receive data, is called latency, also known as receiver set-up time.

In order for the IrDA link to be robust, certain measures were taken to prevent ambient noise from affecting the link. IrDA specifies the test methods for measuring the data integrity of the link under electromagnetic fields, sunlight, incandescent lighting and fluorescent lighting.

### IrDA Compliance

IrDA has a Compliance Trade-mark and a Service Mark, shown in Figure 9a and 9b. The use of the Service Mark can be used freely on literature and equipment by IrDA members. This mark does not represent IrDA Compliance. The IrDA Compliance Trade-mark represents Compliance to IrDa Standards. A one-time fee per company of \$500 for IrDA members and \$1000 (U.S. Dollars) for non-IrDA members is required. In addition, the product carrying this trademark must have a valid Implementation Guide For IrDA Compliance and Compliance Certificate on record with IrDA. The full form, as of July 1995, is included in the Appendix for your convenience.



Figure 9a. IrDA Service Mark.

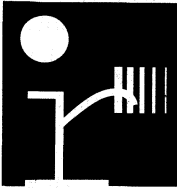

Figure 9b. IrDA Compliance Trademark.

## IR Applications

### Desktop PC and Notebooks

Many PC systems make use of an I/O chip in to control floppy disk drives, hard disk drives, modems, parallel ports, and other serial ports. Such systems can make use of special I/O chips which can also control the IR link, and will directly interface to the HSDL-1000 for full IrDA communication. I/O chips made by various semiconductor manufacturers including National Semiconductor and Standard Microsystems Corporation (SMC) are designed for IR communication, and are suitable for interface with the HSDL-1000. The following I/O chips are recommended for interface with the HSDL-1000:

- National Semiconductor  
PC87334VLJ or PC87334VJG
- SMC  
FDC37C665IR or  
FDC37C666IR

For any I/O chip, the Configuration Register bits must be set so that the I/O chip is set to operate in the proper modes. The settings

should be Half-Duplex, IrDA, SIR, transmit active high, and receive active low where applicable. UART2 is usually enabled by the bit settings.

### Special Note for Interface with the National Semiconductor PC87334:

An IR system comprising the HSDL-1000 and the National Semiconductor PC87334 I/O chip performs to IrDA standards when

correctly implemented on a printed circuit board according to the board layout guidelines in this design guide. Errorless transmission can be obtained at distances of at least 1 meter between transmitter and receiver. If the PC87334 I/O chip is used with the HSDL-1000, then UART2 is the recommended IR interface. Figure 10 shows the recommended hardware connection:

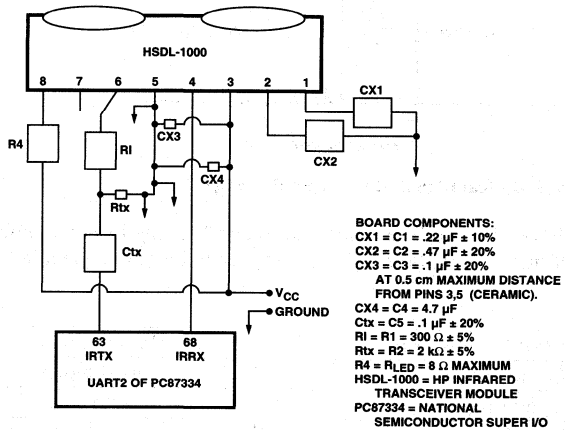

Figure 10. Schematic of Super I/O and HSDL-1000.

Components Ctx and Rtx are necessary with the PC87334 because during any reset of UART2, PC87334 pin 63 is set high. If Ctx and Rtx is not implemented, and IRTX pin 63 is set high for any significant length of time (>500 ms), then the HSDL-1000's LED would be driven above the Absolute Maximum Rating for average LED current.

Once the hardware is complete, the IR Configuration Register of the PC87334 must be set-up for IR communication. National Semiconductor's BIOS especially for the PC87334 is recommended for this purpose. Following every reset of the PC87334, the IR Configuration Register bits will need to be set-up for IR communication. The IR Configuration Register bits should be set as follows:

Register Bit	Setting
0	Set to 1 for SIR mode on UART2
1	Set to 1 for half-duplex mode (IrDA standard)
3, 2	Set to 01 (bit 3 to 0 and bit 2 to 1) for IR signals on UART2 pins
4	Set to 0 for IR pulse width fixed at 1.6 $\mu$ s Set to 1 for IR pulse width = 3/16 baud period

### UARTs (16550 or Similar)

Many electronic machines such as PDAs, modems, and analytical instruments can make use of 16550 or similar UARTs for I/O interface. The UART signals are 100% duty-cycle (full bit width) and need to be modulated/demodulated for the HSDL-1000 IR transceiver module. The HSDL-7000 Endec (Encode/Decode) chip is recommended for the modulation/demodulation functions. The HSDL-7000 chip requires a 16x Clock or Baudout

signal from the UART in order to determine the baud rate for correctly modulating/demodulating the signal pulses.

The HSDL-7000 provides the modulation of UART-type full-bit-width data into 3/16th-bit-width IrDA type data for IR transmission. The HSDL-7000 also provides demodulation of the HSDL-1000 RXD 3/16th-bit-width output into full bit width UART type data. An IR system using a 16550 UART and the HSDL-7000

Endec can be realized with the connections shown in Figure 11.

The HSDL-7000 requires a 16x Clock or Baudout signal in order to correctly modulate and demodulate the UART and IR signals. The 16x Clock or Baudout signal needs to be 16 times the data rate of the UART data coming into the HSDL-7000. UART's such as the 16550 UART typically provide a 16x Clock/Baudout signal pin for easy connection to the HSDL-7000.

### 3/16 Endec Netlist

System designers that do not require the functionality of a full I/O chip, and do not wish to use a discrete UART, often implement the I/O functions into a system ASIC. The modulation/demodulation function required for IR can be incorporated into the system ASIC, so that the ASIC can interface directly with the HSDL-1000 IR transceiver module. The HSDL-7000 Encode/Decode chip can be incorporated into the system ASIC to perform the modulation/demodulation.

The HSDL-7000 Endec netlist is available for ease of incorporation into a system ASIC.

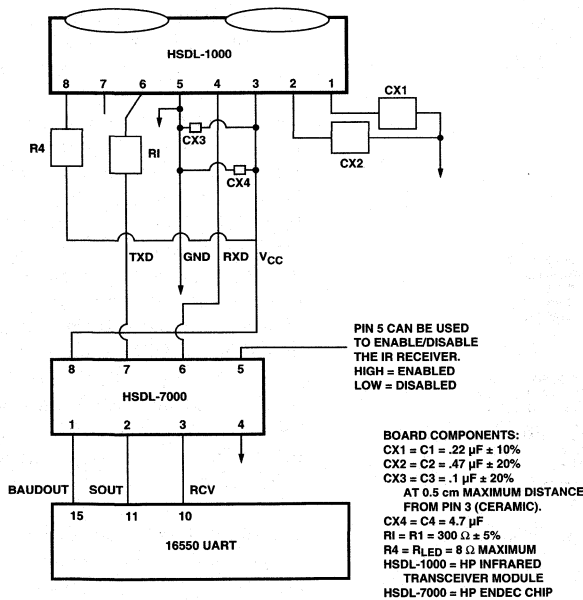

Figure 11. 16550 UART Application Diagram.

Please contact your Hewlett-Packard Component Sales Representative for information regarding the HSDL-1000.

### RS-232

Some electronic systems require off-board, or subsystem implementation of IR. If such systems use an RS-232 interface for IR, then IR can be implemented as shown in Figure 12.

The RS-232 implementation would interface to the following

pins: RTS, DTR, TXD, and RXD. Such a system would need software drivers to correctly configure the RTS and DTR signals to convey baud rate information. The software drivers and related hardware are needed to fully implement this solution. Please refer to reference list in the Appendix for contact information.

### Microcontrollers

Hewlett-Packard is currently working on a recommendation for the IR interface to such microcontrollers as the Intel 8051 and 8031, or the Motorola HC05, HC08, and HC11. Please contact your local Hewlett-Packard sales representative for current information.

### Extended Link Distance

Receiver sensitivity and transmission intensity are the main factors affecting link distance. To extend the link distance, both sensitivity and intensity must be increased on one end of the IR link, or either sensitivity or intensity must be increased on both ends of the IR link. Assume there are two ends of an IR link labeled A and B. If both sensitivity and intensity are increased for end A, then A's transceiver can both receive and transmit at longer distances regardless of what transceiver is at end B. If only transmission intensity is increased for end A, then the transmission intensity of end B must also be increased in order to increase link distance. Otherwise, B's transceiver could move further from A and still receive A's signal, but A could not receive B's transmitted signal at the extended distance. The same is true if only receiver sensitivity is increased.

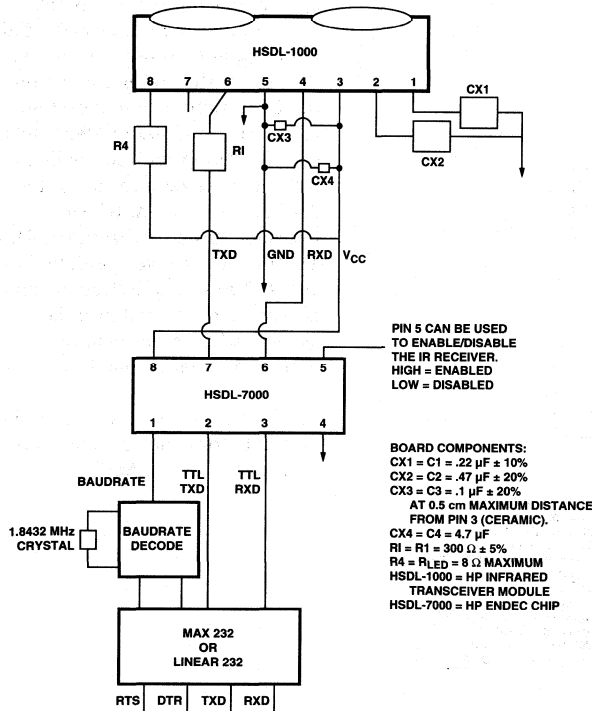

Figure 12. RS-232 Interface Diagram.

The HSDL-1000 provides guaranteed errorless data transmission from 0 cm to 1 meter under recommended operating conditions. In typical applications, the link distance can reach 2 meters. Typical link distance can be increased if the transmission intensity is increased at both ends of the IR link. If the LED current pulse amplitude of both ends of the IR link are increased from the recommended 250 mA to 500

mA, the link distance can typically reach as far as 3 m at 115.2 Kb/s, but guaranteed over recommended operating conditions as far as 1.5 meters.

The HSDL-1000 features the ability to drive an external LED for added power, as shown in Figure 13a. The HSDL-4220 IR emitter or the HSDL-4230 IR emitter can be connected in series or in parallel with the HSDL-1000's internal LED. The HSDL-4220 typically provides 190 mW/sr of intensity at a peak pulse current of 250 mA, and has a viewing angle of 30 degrees. The HSDL-4230 typically provides 375 mW/sr of intensity at a peak

pulse current of 250 mA, and has a viewing angle of 17 degrees. Refer to the HSDL-4220 and HSDL-4230 data sheets in the Appendix for more information.

Connection of an external IR LED in parallel with the LED in the HSDL-1000 can be implemented as shown below. Resistors R3 and R4 should be chosen to provide the appropriate LED current as described in the Figure 13b.

The combined intensity of the HSDL-1000 internal LED and the HSDL-4220 or HSDL-4230 external LED can be used to calculate the potential link distance. Link distance is

proportional to the square root of the total intensity of the signal. The table below demonstrates the link distances which can be achieved under typical operating conditions. Guaranteed link distances over the recommended operating range will reduce the link distance.

Transmission signals with less than 20 percent duty cycle can be used to obtain even further link distance. LED pulses of peak amplitude larger than 500 mA can be used if the pulse duty cycle is decreased below 20 percent. The recommended maximum average LED current for the HSDL-1000 is 100 mA. An LED pulse of 500 mA peak amplitude and 20% duty cycle corresponds to 100 mA average LED current. If an IrDA allowable 1.6  $\mu$ s pulse at 9600 bits/second is used (1.53 percent duty cycle), then an LED pulse of 1 amp peak amplitude can be used and still not exceed the 100 mA maximum average LED current.

Successful link communication at 9.6 Kb/s has been demonstrated at distances exceeding 10 meters with an external HSDL-4230 LED connected to the HSDL-1000. Both the HSDL-4230 LED and the HSDL-1000 LED were driven with 1 amp peak amplitude pulses of 1.6  $\mu$ s pulse width.

Figure 14 demonstrates the effect of receiver sensitivity ( $\mu$ W/cm<sup>2</sup>) and transmission intensity (mW/sr) on link distance. For a given receiver sensitivity (40  $\mu$ W/cm<sup>2</sup>) and a given transmission intensity (40 mW/sr), the theoretical link distance in meters can be determined.

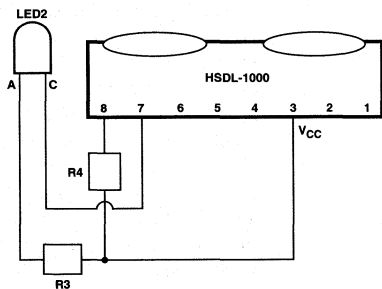

COMPONENTS:  
R3 = LED2 BIAS RESISTOR = 8  $\Omega$  MAXIMUM  
R4 = MODULE LED BIAS RESISTOR = 8  $\Omega$  MAXIMUM  
LED2 = EXTERNAL LED  
HSDL-4220 OR HSDL-4230 RECOMMENDED  
HSDL-1000 = IR TRANSCEIVER MODULE

Figure 13a. Extended Distance Schematic.

Transmitting Devices	LED Pulsed Drive Currents (I <sub>peak</sub> )	Total LED Typical Intensity On-Axis	Typical On-Axis Link Distance
HSDL-1000	250 mA	100 mW/sr	2.0 meters
HSDL-1000	500 mA	200 mW/sr	2.8 meters
HSDL-1000 and HSDL-4220	250 mA each	290 mW/sr	3.4 meters
HSDL-1000 and HSDL-4230	250 mA each	475 mW/sr	4.4 meters

INFRARED PRODUCTS

V+ LED Pull-up Supply Voltage (V)	R <sub>LED</sub> Pull-up Resistor (Ω) (R3 or R4 and Eval Board)	I <sub>LED</sub> (mA)
4.5	4.3	465
4.5	5.6	357
4.5	6.2	323
4.5	6.8	294
4.5	7.5	266
5.0	5.1	490
5.0	5.6	446
5.0	6.8	368
5.0	7.5	333
5.0	8.2	305
5.0	9.1	275
5.0	10.0	250

$$I_{LED} = (V + 2.5 \text{ V}) / R_{LED}$$

Figure 13b. HSDL-1000 LED Resistor Selection Table.

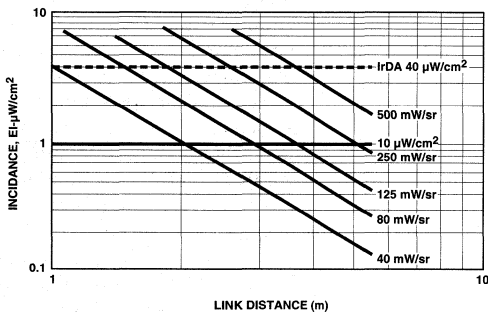

Figure 14. Incidence vs. Link Distance vs. Transmit Intensity.

### Software Drivers and Application Programs

The following list of manufacturers provides application software and drivers utilizing IR hardware. The addresses and phone numbers are listed in the Appendix under Reference List.

- Microsoft (Windows 95)
- Puma Technology (Application Software)
- Traveling Software (Application Software)
- Connexus (Windows Drivers)
- Parallax (IR Drivers for PDAs)

## HSDL-1000 Design Guidelines

### Product Description

#### Block Diagram

The HSDL-1000 transceiver module performs infrared data transfer compliant to the IrDA physical layer specifications, at data rates up to 115.2 Kb/s. The modular design enables ease of implementation, and ease of compliance to IrDA angular specifications. The design of the receiver circuitry enables error free data transfer at guaranteed link distances from 0 meters (nose to nose) to at least 1 meter.

The HSDL-1000 schematic diagram shows the operation of the HSDL-1000. Both pins of the LED are accessible in order to implement additional LEDs in series or in parallel if desired. A daylight cancellation circuit in the first stage amplifier of the receiver uses CX1 to filter out ambient light. The output of the first stage amplifier is capacitively coupled to the comparator to extract only the AC component of the signal.

### Dynamic Range

The wide dynamic range, over 5 orders of magnitude, required by the IrDA physical layer specification necessitates automatic adjustment of the receiver to incoming signal levels. The HSDL-1000 uses feedback and limiting within the first stage amplifier circuitry to enable quick adjustment to incoming signal levels. The amplifier design allows maximum sensitivity for low power signals ( $4 \mu\text{W}/\text{cm}^2$ ) and also limits pulse width distortion during high power signals ( $500 \text{ mW}/\text{cm}^2$ ). The realized performance with this special design eliminates the need for any additional automatic gain control, AGC circuitry.

AGC circuitry can be used in an IR receiver to obtain wide dynamic range. The presence of AGC circuitry is not a guarantee that the IrDA specifications will be met. Imprecise design of the AGC circuitry has been shown to lead to bit errors at large signal levels (short IR link distances). The complete IR system should be tested for IrDA compliance at both short (nose-to-nose) and long (1 meter) distances regardless of the design methodology used to obtain wide dynamic range.



### *Ambient Light*

The HSDL-1000 IR transceiver module makes use of several technologies to reduce the interfering effects of ambient light on correct IR signal reception. The package mold compound is tinted with dye to filter out light wavelengths below the IR wavelengths of 850-900 nm. The lens of the detector is designed to focus light within the IrDA viewing angle. The first stage amplifier of the receiver contains daylight cancellation circuitry to eliminate the ambient light portion of incoming signals. HP has ensured robust performance in adverse conditions.

### *EMI Immunity*

The HSDL-1000 has excellent EMI Immunity when board layout is implemented according to the board layout section of this design guide. The EMI Immunity is greater than 200 volts/meter for any square wave noise source, and even higher for sinusoidal noise sources. A 10 volt peak-peak square wave signal source placed 5 cm from the HSDL-1000 would produce EMI of 200 volts/meter.

All IR transceiver solutions require improved ground plane design and capacitive decoupling over standard practices for digital integrated circuits. Any IR transceiver solution, modular or discrete, has both analog functions and digital functions. The analog functions (IR detector, preamplifier) are more sensitive to EMI and power supply noise than typical digital integrated circuits.

### *Transmitter*

The transmitter uses a high speed, high efficiency TS AlGaAs LED, along with a high speed drive circuit to produce high power IR pulses with minimal pulse width distortion. The efficiency of the LED and the package design enable maximum light intensity at the minimum drive current of 250 mA. The speed of the LED and drive circuitry minimize the rise and fall times of the LED signal edges, improving the detection capability of the corresponding IR receiver.

The HSDL-1000's transmitted intensity  $I_E$  at 250 mA LED current is guaranteed to be at least 44 mW/sr over the normal operating life of the transceiver module, if the recommended operating conditions are followed. The HSDL-1000 guarantees a minimum intensity of 44 mW/sr, which is 10% above the IrDA minimum of 40 mW/sr. This additional power allows for losses through a cosmetic window of about 10%, so that the minimum IrDA intensity can still be met.

The HSDL-1000 is a fully integrated transceiver. It includes the optics, LED and PIN photodiode, LED driver and receiver circuits in one package. It performs the IR transmit and receive functions for the system. The transmitter side of the HSDL-1000 converts the nominally 3/16th bit width

electrical pulses from the modulator into IR light pulses. On the receiver side, the HSDL-1000 also detects IR light pulses and converts them to TTL level electrical pulses for the demodulator. The block diagram, Figure 17, shows the partitioning an IR system using the HSDL-1000.

### **Mechanical Considerations**

#### *Lead Bend Options*

The HSDL-1000 has four lead-bend options. See Figure 15.

X01: Module lies flat on the board with the lens facing up from the horizontal board surface.

X02: Module sits upright at the board edge with the lens facing parallel to the horizontal board surface. Module sits with the board plane intersecting the body of the module. All leads point back to the board and are surface mount.

X03: Module sits upright on the board with lens facing parallel to the horizontal board surface. Some leads are surface mount and others are through-hole. Leads point both front and back for stability.

X04: Module sits upright on the board with the lens facing parallel to the horizontal board surface. All leads are surface mount.

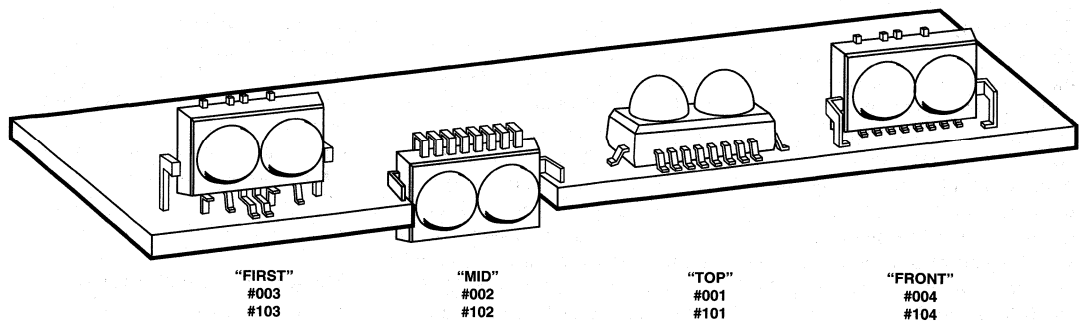

**Figure 15. HSDL-1000 Mounting Options.**

*Pad Layout*

Please refer to the HSDL-1000 data sheet for details on package and lead dimensions. The recommended pad layouts for each lead configuration are shown in Figures 16a - 16d.

The leadframe of the HSDL-1000 actually extends on both sides of the package and provides proper

centering of the leadframe in the mold. There are four leads on one side and eight leads on the other. The four leads are sheared off after molding, but they are slightly exposed. These leads are still active and caution must be used to avoid contacting these leads to any conductive material.

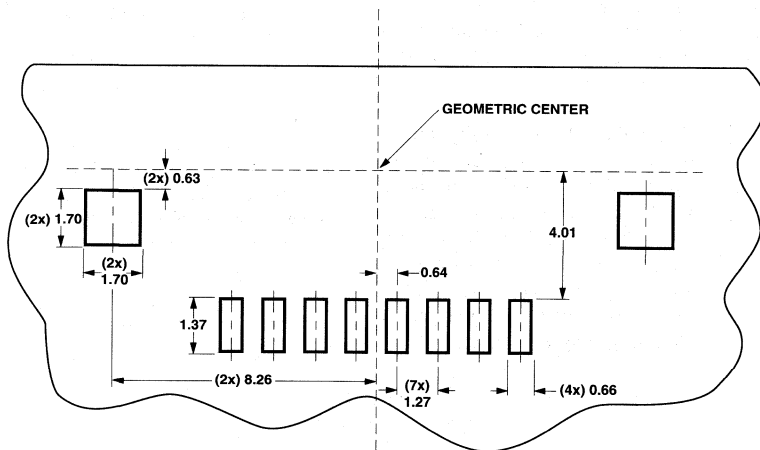

**Figure 16a. Pad Layout Diagram Option #X01.**

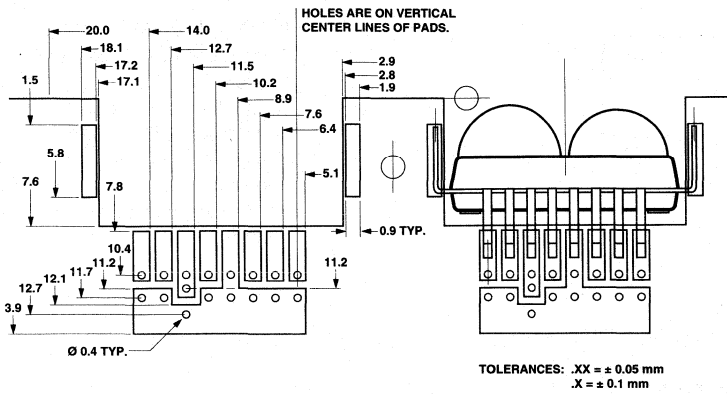

Figure 16b. Pad Layout Diagram Option #X02.

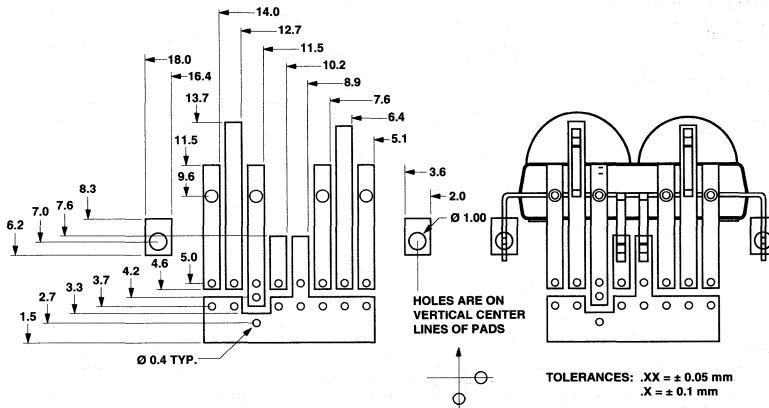

Figure 16c. Pad Layout Diagram Option #X03.

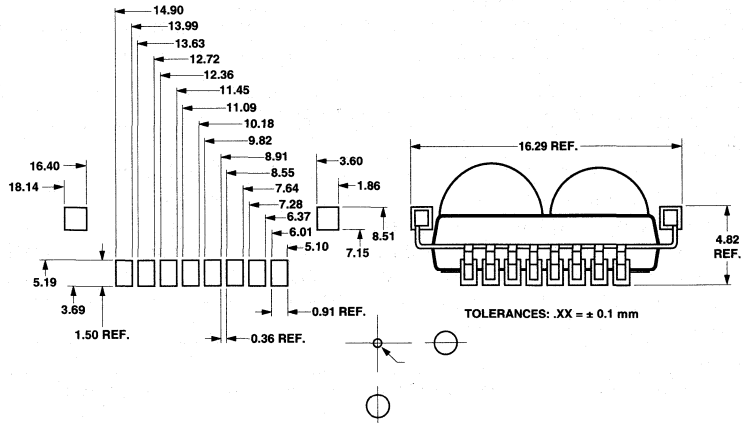
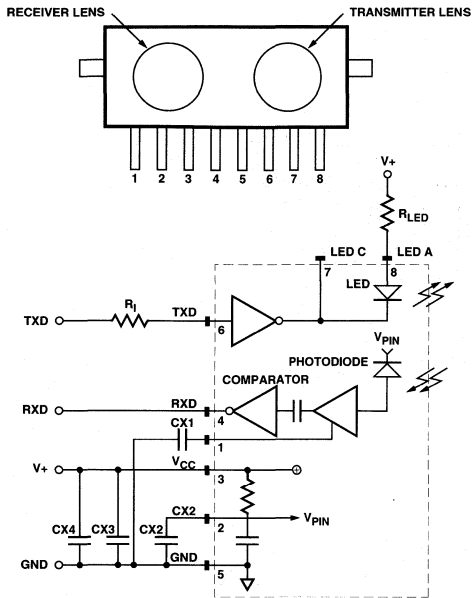

Figure 16d. Pad Layout Diagram Option #X04.



### External Components

The values of the external components CX1, CX2, CX3, CX4,  $R_I$ ,  $R_{LED}$ ,  $C_{tx}$ , and  $R_{tx}$  should be chosen according to the recommendation table on the data sheet and the recommended interface circuits in the IR Applications Section.

Figure 17. HSDL-1000 Schematic Diagram and Pinout Description.

### Electrical Considerations

Component	Recommendation
CX1	Should not deviate from 0.22 $\mu\text{F}$ , and is crucial to the daylight cancellation circuitry. Merging of received bits may occur if the CX1 value is too large. Loss of receiver sensitivity may occur if the CX1 value is too small.
CX2	Should be a minimum of 0.4 $\mu\text{F}$ , and can be higher if feasible to implement on the board.
CX3	Nominally 0.1 $\mu\text{F}$ and small enough in size to be as close as possible (<0.5 cm) to pins 3 and 5 of the HSDL-1000.
CX4	Should be 4.7 $\mu\text{F}$ minimum, and can be made larger to improve noise immunity.
$R_I$	Nominally 300 ohms.
$R_{LED}$	Range from 4 to 10 $\Omega$ depending upon the board supply voltage $V_{CC}$ . The data sheet requires $R_{LED}$ to be 8 $\Omega$ maximum, in order to allow the $V_{CC}$ to drop as low as 4.5 V. A minimum LED current of 250 mA is then guaranteed. $R_{LED}$ should be chosen so that the minimum LED current is 250 mA over the full range of $V_{CC}$ in the actual application. If $V_{CC}$ is guaranteed not to go below 5 V, then a value as high as 10 $\Omega$ can be used for $R_{LED}$ . See the HSDL-1000 Source Calibration Table in the IrDA Compliance section for the resulting $I_{LED}$ from various $V_{CC}/R_{LED}$ combinations.
$R_{tx}^*$	Nominally 2 k $\Omega$ .
$C_{tx}^*$	Nominally 0.1 $\mu\text{F}$ in order to minimize pulse width distortion while AC coupling the data input.

\* $R_{tx}$  and  $C_{tx}$  are only necessary in applications where the Txd pulse duty cycle is such that the Txd pulse width can be greater than 90  $\mu\text{s}$ , such as interfacing to the National Semiconductor Super I/O chip. Refer to Figure 10.

**PCB Layout for Noise Immunity**

Special attention to the recommended PCB layout guidelines will minimize the effects of EMI (Electro-Magnetic Interference) and PSN (Power Supply Noise) on the performance of the HSDL-1000's receiver. The effects of EMI and PSN can potentially reduce the sensitivity of the HSDL-1000's receiver resulting in reduced link distance. EMI can also generate spurious bits on the receiver output Rxd, when no IR signal is being received. HSDL-1000 evaluation boards which demonstrate the correct board layout, can be obtained from your local Hewlett-Packard Component Sales Representative.

**EMI Immunity**

EMI is radiated by switched mode power supplies, dc/dc converters, external monitor I/O ports, power ports, or clock generators. The distance of the HSDL-1000 to such EMI sources determines the EMI field strength required by the HSDL-1000 module. The EMI field strength at the HSDL-1000 must be less than the minimum EMI Immunity of the HSDL-1000 in order for error free performance.

EMI field strength is measured in volts/meter. A 200 volt EMI source placed 1 meter from the HSDL-1000 represents a 200 V/m field strength to the HSDL-1000. A 10 volt EMI source placed 5 cm from the HSDL-1000 also represents a 200 V/m field strength to the HSDL-1000.

EMI Immunity is the maximum field strength of EMI that the HSDL-1000 can tolerate while maintaining a receiver BER < 10<sup>-9</sup>. If the EMI Immunity of the HSDL-1000 is 200 V/m

then the distance of the EMI source to the HSDL-1000 must be increased until the EMI field strength is less than 200 V/m at the HSDL-1000 module.

The following recommendations for PCB layout should provide sufficient EMI immunity for error free IR link operation:

1. V<sub>CC</sub> bypass capacitor CX3 should be ceramic, and positioned as close as possible to the module (within 0.5 cm of pins 3 and 5 of the module)
2. Multi-layer PCB is recommended so that a sufficient ground plane can be properly placed.
3. The board underneath the module, and 3 cm in any direction around the module is defined as the critical ground plane zone. The board's ground plane should be maximized in the critical ground plane zone. Any unused board space in the critical ground plane zone should be filled with ground metal. Unused board space is defined as board space not used for other connections/traces.
4. The ground plane for the HSDL-1000 should have a very low impedance connection to a clean/noiseless ground node. The noise on the ground node should be 10 mV or less for optimum receiver performance. The HSDL-1000 ground plane connection to board ground should be separated by a high impedance to ground connections of power supplies, digital switching circuits, or other noise sources. The impedance between HSDL-1000 ground and noise source ground can be increased by minimizing the conductive or ground plane paths between them (both number of traces and trace size). An example of this recommended connection is shown in Figure 18a.
5. The components recommended for each particular application should be placed within the board area where the HSDL-1000 ground plane has been maximized. CX1, CX2, CX3, and CX4 (if used for the particular application) should be placed as close to the module as possible. The ground plane metal can be extended beyond the critical

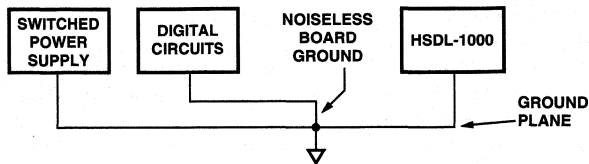

Figure 18a. HSDL-1000 Ground Connection.

The table below shows the expected EMI Immunity performance when following the guidelines above.

Signal Source	Frequency	EMI Immunity (V/m)
Square Wave	0 Hz to 10 kHz	≥ 285
Square Wave	10 kHz to 300 kHz	≥ 235
Square Wave	>300 kHz	≥ 305
Sinusoidal	All	≥ 305

ground plane zone in order to accommodate components, or to further improve EMI immunity.

- All signal or noise sources (power ports, monitor ports, clock generators, switched mode power supplies) should be located at least 5 cm away from the module, and outside of the HDSL-1000 ground plane.

If the peak signal amplitude of a noise source is known, then the EMI field strength at the HSDL-1000 can be calculated in volts/meter. The distance of that source to the HSDL-1000 can be adjusted above or below 5 cm in order to maintain an EMI field strength less than the EMI Immunity.

Compromises in board layout from the recommended layout can result in a significant reduction in EMI immunity. Factors such as increased lead/trace length from pins 3,5 of the HSDL-1000 to CX3 and CX4, or reduced ground plane area, can degrade EMI immunity by 50% or greater. Curves of EMI Immunity versus Frequency for the recommended board layout, and a compromised board layout are shown on Figure 19a.

#### Power Supply Rejection (PSR)

Power supply noise can be coupled into the HSDL-1000's receiver through  $V_{CC}$  or ground lines. Power supply ripple is a common example of power supply noise. PSR (Power Supply Rejection) refers to the HSDL-1000's ability to tolerate power supply noise, while maintaining error free operation. Proper PCB layout techniques and external component placement can ensure successful operation with power supply noise present on  $V_{CC}$  or ground.

The recommendations for board layout below should provide sufficient PSR for error free IR link operation:

- The least noisy power source available on the application board should be chosen for  $V_{CC}$  of the HSDL-1000 module. Biasing  $V_{CC}$  of the HSDL-1000 directly from a noisy switched mode power supply line should be avoided.
- The  $V_{CC}$  line to the HSDL-1000 module should be filtered sufficiently so that less than 10 mV of noise is present at either pin 3 or pin 5 of the module. The recommended values of CX3 and CX4 should provide

sufficient filtering in most cases. CX3 and CX4 can be increased in value if more filtering is necessary.

- $V_{CC}$  bypass capacitor CX3 should be ceramic, and positioned as close as possible to the module (within 0.5 cm of pins 3 and 5 of the module)
- The board underneath the module, and 3 cm in any direction around the module is defined as the critical ground plane zone. The board's ground plane should be maximized in the critical ground plane zone. Any unused board space in the critical ground plane zone should be filled with ground metal. Unused board space is defined as board space not used for other connections/traces.
- The ground plane for the HSDL-1000 should have a very low impedance connection to a clean/noiseless ground node. The noise on the ground node should be 10 mV or less for optimum receiver performance. The HSDL-1000 ground plane connection to board ground should be separated by a high impedance to ground connections of power supplies, digital switching circuits, or other noise sources. The impedance between HSDL-1000 ground and noise source ground can be increased by minimizing the conductive or ground plane paths between them (both number of traces and trace size). An example of this recommended connection is shown in Figure 18a.

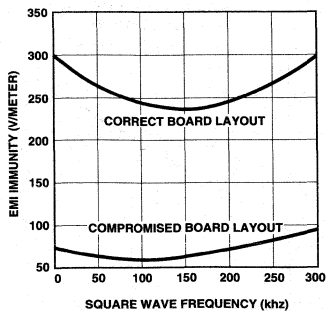

Figure 19a. EMI Immunity vs. Square Wave Noise Signal Frequency.

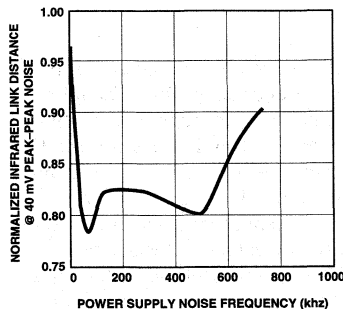

Figure 19b. Infrared Link Distance versus Power Supply Noise Frequency.

The effect of power supply noise on HSDL-1000 receiver sensitivity is shown Figure 19b. A 1 meter infrared link is constructed with a power supply noise sine wave of 40 mV peak-peak amplitude applied to the  $V_{CC}$  pin of the link's receiving HSDL-1000 module. The sine wave is modulated on top of the DC positive supply voltage. The frequency of the sine wave is varied from 1 Hz to 700 kHz for the measurement. The IR link's transmitting LED forward current is adjusted to maintain a link  $BER \leq 10^{-6}$  for each noise sine

wave frequency at a fixed distance.

The normalized link distance operating at a  $BER \leq 10^{-6}$  is derived from the LED forward current at each frequency and compared to the maximum IR link distance no power supply noise at a  $BER \leq 10^{-6}$ . Normalized IR link distance  $d = \sqrt{[(I_{LED}@no\ noise) / (I_{LED}@f)]}$  where  $f$  = frequency of the noise signal.

#### Improving EMI Immunity and PSR

If EMI noise or power supply noise are suspected in causing reduced sensitivity or link distance, then the signal on Rxd of the receiving HSDL-1000 should be measured with the link in an idle state (no IR transmission). If bits are observed on Rxd, then noise is coupling into the receiver causing spurious bits on Rxd. The receiving HSDL-1000 should then be biased from a separate clean dc supply (such as a battery). If spurious bits are still observed on Rxd of the receiving HSDL-1000, then the noise is most likely due to EMI. If Rxd looks clean when biased from a separate dc supply, then the noise is most likely  $V_{CC}$  or Ground noise.

The first step in improving EMI immunity and Power Supply Rejection is to confirm that the recommended board layout has been followed.

The following steps specifically improve EMI Immunity, but can also improve PSR:

1. Increase the ground plane under the HSDL-1000 module. Extend the ground plane

further out from the module. For a multi-layer board, use board layers underneath and near the HSDL-1000 for additional ground plane.

2. Move CX3 closer to module pins 3 and 5. Increase CX3 from its nominal value (0.1  $\mu F$ ).
3. Move CX4 closer to the module, and increase CX3 from its nominal value (4.7  $\mu F$ ).

The following steps specifically improve **PSR**, but can also improve EMI Immunity:

1. Connect  $V_{CC}$  of the HSDL-1000 to a DC power board trace with measured noise  $\leq 10$  mV. For a multi-layer board, use one layer underneath and near the HSDL-1000 as  $V_{CC}$ , and sandwich that layer between ground connected board layers. For example in a four-layer PCB, layer 1 (top) contains traces, layer 2 contains ground underneath the module and surrounding areas, layer 3 contains  $V_{CC}$ , layer 4 (bottom) contains traces and ground metal.
2. If possible, move CX3 closer to module pins 3 and 5. Increase CX3 from its nominal value (0.1  $\mu F$ ).
3. If possible, move CX4 closer to the module, and increase CX3 from its nominal value (4.7  $\mu F$ ).
4. Connect the ground plane of the HSDL-1000 to a ground node with  $<10$  mV noise. Separate the HSDL-1000 connection to ground from

power supply or digital switching circuits connections to ground.

- Implement a PI filter on  $V_{CC}$  as shown in Figure 19c.

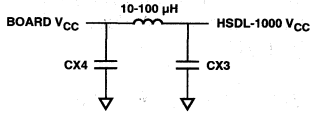

Figure 19c. PI Filter.

### Optical Port Design

#### Aperture Dimensions and Orientation

Figure 20 shows a module positioned with respect to the

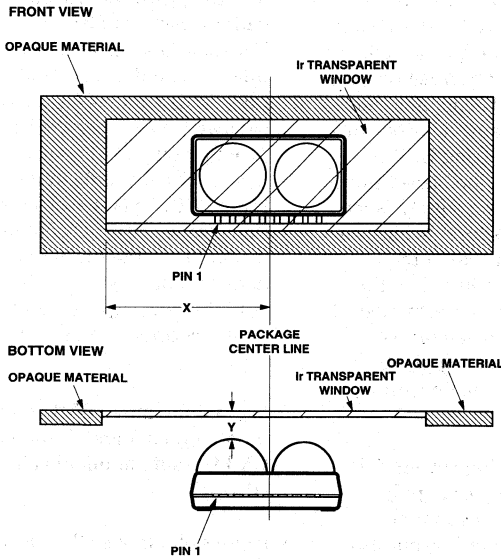

Figure 20. Position of Module with Respect to Product Case.

Recommended Plastic Materials:

Material #	Light Transmission	Haze	Refractive Index
Lexan 141L	88%	1%	1.586
Lexan 920A	85%	1%	1.586
Lexan 940A	85%	1%	1.586

Note: 920A and 940A are more flame retardant than 141L.

front panel of a hypothetical product. Dimension 'Y' is the distance between the apex of the receiver side lens and the outside face of the front panel. Dimension 'X' is the distance from the middle of the module to the edge of the IR transparent window, which is defined as the 'Aperture Half Width.' For a given 'Y' design, the Aperture Half Width 'X' must be less than or equal to the value shown in Figure 21. For dimensions greater than 5 mm, the following equation can be used to calculate X:  
 $X = 2.87 * Y + 7.0$ .

#### Window Material Selection

The HSDL-1000 data sheet specifications for Transmitter Radiant

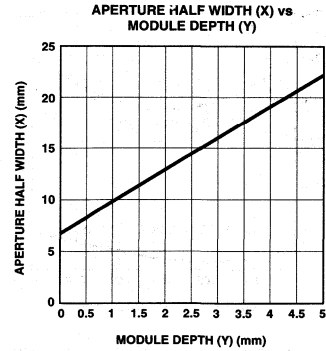

Figure 21. Maximum Aperture Half Width as a Function of Module Depth.

Intensity and for Receiver Input Irradiance allow for 10% light signal loss through a cosmetic window placed in front of the IR transceiver module. The recommended plastic materials for use as a cosmetic window are available from General Electric Plastics, see Reference List in the Appendix for contact information.:

Recommended Dye: Violet #21051 (IR transmittant above 625 nm)

Improved receiver performance in the presence of ambient light (sunlight, fluorescent light, incandescent light) can be attained by indenting the module into the system box by a few millimeters. The overhang of the system box will minimize the amount of direct ambient light that the HSDL-1000 detector sees. The cosmetic window will also help reflect ambient light away from the module.



## New Products

### *HSDL-1001: 115 Kb/s Infrared IrDA Compliant Transceiver*

The HSDL-1001 is an improved version of the HSDL-1000. HP plans to offer and support both the HSDL-1000 and HSDL-1001. A preliminary data sheet is located in the Appendix. The following table summarizes the performance enhancements of the HSDL-1001.

Parameter	HSDL-1000	HSDL-1001
Supply Voltage	5 V	3 V to 5 V
Idle I <sub>CC</sub>	1.1 mA	165 µA
Receiver Latency	8 ms	100 µs
Shutdown Pin	No	Yes
External Passive Components	6-8	3-5
TXD Input Current	4.5 mA	100 µA

## IR System Testing

### IrDA Physical Layer Compliance

Obtaining IrDA compliance for the completed IR system is important not only to permit the use of the IrDA trademark, but in order to guarantee interoperability with equipment produced by

### *HSDL-1100: 1.15/4 Mb/s Infrared IrDA Compliant Transceiver*

With the approval of the higher speed (1.15 MB/s and 4 Mb/s) IrDA standard in April, 1995, Hewlett-Packard is designing a transceiver module compliant to this standard, the HSDL-1100. A preliminary data sheet is located in the Appendix.

### *HSDL-44XX/54XX: IR Emitter and PIN Photodiode in a Subminiature SMT Package*

For applications that require small, surface mount, and short distance IrDA-type links, such as pagers and hand held devices, the HSDL-44XX emitter and HSDL-54XX detector may fit your application. A preliminary data sheet is located in the Appendix.

Please consult your local HP Components Sales Representative regarding samples and availability of these future products.

other manufacturers. Such interoperability will greatly increase the value of your IR system in the perspective of the end user. Both short distance, nose-to-nose, and long-distance (1 meter), performance should be verified for any proposed IR system seeking to be IrDA compliant. IR compo-

nents of some manufacturers, advertised as IrDA compatible or compliant, currently do not meet the required performance at both short and long link distances. The HSDL-1000/HSDL-1001 is tested in production in order to guarantee IrDA compliance for both short and long distances.

The modular design of the HSDL-1000/HSDL-1001 enables the system designer to easily meet the IrDA physical layer specifications. The design and guaranteed performance of the HSDL-1000/HSDL-1001 ensures that a correctly designed system will meet all of the IrDA physical

layer specifications. Correct system design includes proper board layout and optical interface as described later in this design guide. The Compliance Tables below demonstrate the guaranteed performance of the HSDL-1000/HSDL-1001 in an IR system, and can be used to complete the Product Declaration

of Compliance form located in the Appendix.

For IR detectors:  $I_E$  (mW/sr) = [(Measured Power (mW))\* (1 meter/L)<sup>2</sup>] / (Detector Area (meters<sup>2</sup>)), where L is the distance, in meters, from the HSDL-1000/HSDL-1001 under test to the IR detector.

### IR Transmitter Compliance Table

Active Output Specifications	Measured Value or Check	Specifications	Verification Method
Peak Wavelength	875 nm	850 nm to 900 nm	GBD
Active On-Axis Output Power	> 44 mW/sr < 500 mW/sr	40 mW/sr to 500 mW/sr	VBT GBD See Note 1
Half-Angle Where Power is < 40 mW	± 15 to ± 30 degrees 22 degree typical	± 15 to ± 30 degrees	VBT
Optical Rise Time	Typical = 150 ns Maximum = 600 ns	< 600 ns	GBD
Optical Fall Time	Typical = 50 ns Maximum = 600 ns	< 600 ns	GBD
Pulse Overshoot	< 25%	< 25%	GBD
Pulse Jitter	< 200 ns	< 200 ns	GBD

GBD = Guaranteed By the Design of the HSDL-1000/HSDL-1001 module. Characterization data has shown that all functionally good units will meet these specifications.

VBT = Verified by 100% test of production units prior to shipping.

**Note:**

1. Although the HSDL-1000/HSDL-1001 data sheet guarantees a transmitted intensity  $I_E \geq 44$  mW/sr within the IrDA viewing angle, verification of the output power of the overall IR system may be necessary. The orientation of the HSDL-1000 in the IR system box with respect to windows and openings, and the window shape and material, could effect  $I_E$ . Verification that the overall IR system meets the 40 mW/sr minimum can be accomplished with a simple on-axis  $I_E$  test. An IR detector with known area can be placed at 20 cm or greater, on-axis (half-angle = 0), from the IR system window.  $I_E$  can be derived from the measured power captured by the detector. The minimum  $I_E$  within the IrDA viewing angle occurs on-axis for the HSDL-1000/HSDL-1001. See Figure 7 in the HSDL-1000 data sheet located in the Appendix.

## IR Receiver Compliance Table

Active Input Specifications	Yes	No	Verification Method
Receiver correctly generates 0's and 1's when exposed to a pulsed IR signal of 4 $\mu\text{W}/\text{cm}^2$ at 0 degrees	X		See Note 2
Receiver correctly generates 0's and 1's when exposed to a pulsed IR signal of 500 $\text{mW}/\text{cm}^2$ at 0 degrees	X		VBT
Receiver correctly generates 0's and 1's when exposed to a pulsed IR signal of 4 $\mu\text{W}/\text{cm}^2$ at +15 degrees	X		VBT
Receiver correctly generates 0's and 1's when exposed to a pulsed IR signal of 500 $\text{mW}/\text{cm}^2$ at +15 degrees	X		VBT
Receiver correctly generates 0's and 1's when exposed to a pulsed IR signal of 4 $\mu\text{W}/\text{cm}^2$ at -15 degrees	X		VBT
Receiver correctly generates 0's and 1's when exposed to a pulsed IR signal of 500 $\text{mW}/\text{cm}^2$ at -15 degrees	X		VBT
Using a jitter free sequence of IR pulses, what is the jitter in the electrical equivalent of those pulses (< 200 ns)	< 200 ns		GBD
Minimum delay after transmit that the receiver receives error free (< 10 ms)	< 10 ms		GBD

GBD = Guaranteed By the Design of the HSDL-1000/HSDL-1001 module. Characterization data has shown that all functionally good units will meet these specifications.

VBT = Verified by 100% test of production units prior to shipping.

**Note:**

- Although the HSDL-1000/HSDL-1001 data sheet guarantees correct receiver bit generation when exposed to a pulsed IR signal of 3.6  $\mu\text{W}/\text{cm}^2$  within the IrDA viewing angle, verification of the overall IR system's performance may be necessary. The orientation of the HSDL-1000/HSDL-1001 in the system box with respect to windows and openings could effect receiver sensitivity. Verification that the overall IR system meets the 4  $\mu\text{W}/\text{cm}^2$  sensitivity requirement can be accomplished with a simple functional test. A calibrated 40  $\text{mW}/\text{sr}$  IR source can be placed 1 meter from the system IR window for the functional test. Alternatively, the HSDL-1000/HSDL-1001 module can be used as an IR source, if it is calibrated to 40  $\text{mW}/\text{sr}$  with a power meter or the calibrated detector used in the transmitter compliance section.

V+ LED Pull-Up Supply Voltage (V)	R <sub>LED</sub> LED Resistor (Ω)	I <sub>LED</sub> (mA)	HSDL-1000 Light Source to Device Under Test (Source in Open 25-30°C Environment with NO Cosmetic Window) (meters)
4.5	4.3	465	1.73
4.5	5.6	357	1.52
4.5	6.2	323	1.44
4.5	6.8	294	1.38
4.5	7.5	266	1.31
5.0	5.1	490	1.78
5.0	5.6	446	1.69
5.0	6.8	368	1.54
5.0	7.5	333	1.46
5.0	8.2	305	1.40
5.0	9.1	275	1.33
5.0	10.0	250	1.27

The Source to IR System Distance is Calculated as follows:

Source to IR System Distance = (1 meter) \* sqrt[1.61 \* (I<sub>LED</sub>/250 mA)] where 1.61 is a calibration factor for the ratio: (Actual HSDL-1000 transmitted intensity I<sub>E</sub> at T<sub>ambient</sub> = (25-30°C)/(40 mW/sr).

A rough check of adequate transmitter power can be done using the table below. The light source to device under test distance in the right most column should be easily obtained for any IrDA compliant receiving system. The HSDL-1000/HSDL-1001 source should be at ambient temperature of 25-30°C (i.e. not in a closed system box). Cosmetic windows or filters should not be present in

front of the HSDL-1000/HSDL-1001 source. The functional testing can be conducted at a half-angle of 0 degrees and at a half-angle of ± 15 degrees.

#### *General System Testing*

Post-assembly testing of the physical layer of the IR system may be desired in order to guarantee the performance of systems shipped to end users.

The testing need only include parameters/functionality that would be effected by variations in the assembly process. A simple file transfer test, including file compare for error checking, could be done at a link distance of 1 meter, and 15 degrees off axis. Such a test would guarantee link distance, angle, sensitivity, and error free transmission of data.

## Evaluation Boards

The HSDL-8000 evaluation board contains outputs to interface to Super I/O Chipsets, or UARTs. These evaluation boards utilizes the guidelines outlined in this

designers guide and will be available at the end of the year 1995. Please contact your local Hewlett-Packard Component Sales Representative for more information.

## **Reference List**

### **Infrared Data Association**

IrDA  
1776 Ygnacio Valley Road  
Walnut Creek, CA 94598

Phone: (510) 943-6546  
FAX: (510) 943-5600  
irda@netcom.com

### **General Electric Plastics**

General Electric Plastics  
One Plastics Ave  
Pittsfield, MA 01201

Phone: 800-845-0600  
FAX: 413-448-7731

### **IR Software Application and Driver Manufacturers**

#### **Parallax Research**

201 Innovation Centre NTU Nanyang Ave.  
Singapore 2263

Phone: 65 793 0855  
FAX: 65 793 0775

#### **Counterpoint Inc**

5975 NW Burgundy Dr.  
Corvallis, OR 97330

Phone: 541-757-7275  
FAX: 541-745-7735  
patm@countersys.com

### **IrDA Testing**

#### **Genoa Technology**

5401 Tech Circle  
Moorpark, CA 93021

Phone: 805-531-9030  
FAX: 805-531-9045  
<http://www.gentech.com>

#### **Puma Technology**

US Puma Technology  
3375 Scott Blvd. Suite 300  
Santa Clara, CA 95054

Phone: (408) 987-0200  
FAX: (408) 970-8750

Europe Winsoft International, Ltd.  
65 High Street  
Marlowe, Buckinghamshire, SL71AB, UK

Phone: 44 0 628 88 444  
FAX: 44 4 628 478 560

Japan Something Good, International  
City Plaza, Shinjuku, Building 2-5-20  
Okubo, Shinjuku-ku, Tokyo, 169

Phone: 03 32 32 0803  
FAX: 03 32 32 0963

#### **Traveling Software**

Jim Mantell  
18702 North Creek Parkway  
Bothell, WA 98011

Phone: 206-483-8088  
FAX: 206-483-1284

**Implementation Guide for IrDA Compliance**  
**IrDA Standards Version 1.0**  
**Copyright 1994**

**IrDA Physical Layer (IrPHY) Implementation (Mandatory):**  
**Please document your results of the following.**

Specification Version: \_\_\_\_\_

Active Output Specifications	Measured Value or Check	Specification
Peak wavelength		(850 nm to 900 nm)
Active on-axis output power		(40<power<500 mW/Sr)
Angle where power is <40 mW		(30>angle>15 degrees)
Pulse rise time		(<600 ns)
Pulse fall time		(<600 ns)
Pulse overshoot		(<25%)
Pulse jitter		(<200 ns)

\*OK to quote LED data sheet and not measure this parameter

Please describe the setup of the testing environment and equipment (i.e. calibration).

Please document your results by checking the appropriate response:

Active Input Specifications	Yes	No
Receiver correctly generates 0's and 1's when exposed to a pulsed IR signal of 4 $\mu\text{W}/\text{cm}^2$ at 0 degrees		
Receiver correctly generates 0's and 1's when exposed to a pulsed IR signal of 500 $\text{mW}/\text{cm}^2$ at 0 degrees		
Receiver correctly generates 0's and 1's when exposed to a pulsed IR signal of 500 $\text{mW}/\text{cm}^2$ at +15 degrees		

<b>Active Input Specifications (Continued)</b>	<b>Yes</b>	<b>No</b>
Receiver correctly generates 0's and 1's when exposed to a pulsed IR signal of 4 $\mu\text{W}/\text{cm}^2$ at -15 degrees		
Receiver correctly generates 0's and 1's when exposed to a pulsed IR signal of 500 $\text{mW}/\text{cm}^2$ at -15 degrees		
Using a jitter free sequence of IR pulses, what is the jitter in the electrical equivalent of those pulses (<200 ns)		
Minimum delay after transmit that the receiver receives error free (<10 ms)		

What additional features of the specification have you included in the applicant product?

---

***IrDA Link Access Protocol (IrLAP) Implementation (Mandatory)***

Please document your results by circling the appropriate response(s):

Specification Version: \_\_\_\_\_

Minimal Implementation Only	Yes	No
Secondary Only	Yes	No
Primary and Secondary	Yes	No
Baud Rates Supported (bps)		2400, 9600, 19200, 38400, 57600, 115200
Maximum Turnaround Supported (ms)		500, 250, 100, 50, 25, 10, 5
Data Size Supported (bytes)		64, 128, 256, 512, 1024, 2048
Tx Window Size Supported		1, 2, 3, 4, 5, 6, 7
Rx Window Size Supported		1, 2, 3, 4, 5, 6, 7
Number of ROF Req'd @ 11.5 kbps		48, 24, 12, 5, 3, 2, 1
Minimum Turnaround Time (ms) (Please write)		
Link Disconnect/Threshold time(s)		3/0, 8/3, 12/3, 16/3, 20/3, 25/3, 30/3, 40/3
Primary/Secondary Role Exchange	Yes	No
Sniffing	Yes	No

---

***IrDA Link Management Protocol (IrLMP) Implementation (Mandatory)***

Please document your results by checking the appropriate response(s):

Specification Version: \_\_\_\_\_



**IrDA Link Management Protocol (IrLMP) Implementation (Continued)**

	Yes	No
Minimal Implementation Only		
Exclusive Mode		
Primary/Secondary Exchange		
Sniffing		
Connectionless Data Tx		
Connectionless Data Rx		
IAS Client Get Info Base Details Get Objects Get Value Get Value By Class Get Object Info Get Attribute Names		
IAS Get Info Base Details Get Objects Get Value Get Value By Class Get Object Info Get Attribute Names		

---

**IrDA Plug and Play (IrPnP) Implementation (Optional):**

Implemented \_\_\_\_\_ YES NO  
 Specification Version \_\_\_\_\_

PnP Attributes Values:	
Device ID	
Name	
Manufacturer	
Category	
Version	
Status	
Comp Cnt	
Comp #00	
Comp #01	
Comp #02	
Comp #03	

Extend as appropriate.



---

***IrDA Transport Protocol (IrTP) Implementation (Optional):***

Minimal Implementation Only                      YES    NO  
Specification Version: \_\_\_\_\_

---

**INTEROPERABILITY STATEMENT**

List other IrDA Compliant devices with which the applicant device has been demonstrated to interoperate.

List other IrDA Compliant devices with which the applicant device has failed to be interoperable. Where possible please offer your diagnosis of the failure.

---

**TESTING AND QUALITY ASSURANCE STATMENT**

Briefly describe why you believe this device is compatible with the IrDA standard. What methods have been used to ensure IrDA Compliance?

Has an independent test suite been used to validate this implementation? If YES, state which suite and attach sample results.

Briefly describe plans for regression tests for subsequent releases.



## COMPLIANCE CERTIFICATE

The **Compliance Certificate** must be completed and submitted to Infrared Data Association ("IrDA") for each individual product model on which you intend to utilize the beaming IR and IrDA trademarks ("IrDA Trademarks") as required by the **IrDA Trademark License Agreement** ("Agreement"). Submission of (i) a duly authorized signed **Agreement** (with the appropriate fee) and (ii) a signed Compliance Certificate permits the Primary Licensee and other Affiliated parties defined in the Agreement to (a) use the IrDA trademarks on or in relation to (i.e., packaging, advertising, documentation, etc.) a product that has been herein documented designed to be compliant with the IrDA Standards, a (b) state that their developed and/or market system level products have been implemented compliant to the most recent version of the IrDA standard specifications. The receipt of the **Agreement** and the **Compliance Certificate** must be acknowledged by IrDA prior to initiating use of the IrDA Trademarks.

The Implementation Guide Procedures for IrDA Compliance is a guide for documentation and does not substitute or release from obligation referral to the IrDA Standards Specifications for full compliancy design. The Primary Licensee is responsible for the testing and confirmation of product compliance including but not limited to contacted components/subcomponents. Accurate completion of the IrDA Physical Layer, IrDA Link Access Protocol; (IrLAP), and the IrDA Link Management Protocol (IrLMP) sections of the standard are mandatory for the authorized use of the IrDA Trademarks.

---

### **Applicant Information:**

Trademark License Agreement Number: \_\_\_\_\_

Company Name: \_\_\_\_\_

(Primary Licensee)

Division: \_\_\_\_\_

Authorized Contact Name: \_\_\_\_\_

Address: \_\_\_\_\_

Street

City

State

Zipcode

Country

Telephone Number: \_\_\_\_\_ Facisimile: \_\_\_\_\_

**Description of Applicant Device** (Manufacture, Model, Revision, Software Revision (Manufacturer, Title Version No.))

**Manufactured by:**      **Primary Licensee**       **Affiliated Party**       **OEM**

As the duly authorized agent of the Primary Licensee and properly authorized to execute this document on its behalf, I certify the above statements and test results reflected in the Implementation Guide for IrDA Compliance are truthful and accurate. I understand that an misrepresentation of the facts or false statements will result in termination of the Agreement and recission of permission to utilize the IrDA trademarks.

\_\_\_\_\_  
[Type name]

\_\_\_\_\_  
[Signature]

\_\_\_\_\_  
[Title]

\_\_\_\_\_  
[Date]

# Infrared IrDA<sup>®</sup> Compliant Transceiver

## Technical Data

### Features

- **Low Cost Infrared Data Link**
- **Guaranteed to Meet IrDA Physical Layer Specifications**
  - 1 cm to 1 Meter Operating Distance
  - 30° Viewing Angle
  - 2.4 KBd to 115.2 KBd Data Rate
- **Daylight Cancellation**
- **Easily Implemented Direct Connection to Various I/O Chips**
- **Small Form Factor**
- **Several Lead and Shipping Configurations Available**
- **Excellent EMI Immunity (> 10 V/m)**

### Applications

- **Data Comm: Serial Data Transfer Between:**
  - Notebook Computers
  - Subnotebooks

Desktop PCs  
PDAs  
Printers  
Other Peripheral Devices

- **Telecom:** Modem, Fax, Pager, Phone
- **Industrial:** Data Collection Devices
- **Medical:** Patient and Pharmaceutical Data Collection

### Description:

The HSDL-1000 serial infrared module performs low cost, low power, point-to-point, through the air data transfer in a serial, half-duplex mode.

The module has been designed to the IrDA (Infrared Data Association) Physical Layer Specifications. The module is designed to

### HSDL-1000

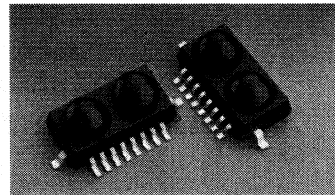

operate from 0 to 1 meter at a data rate of 115.2 Kbd per second at a 30° viewing angle.

The HSDL-1000 contains a high speed, high efficiency TS AlGaAs 875 nm LED, a PIN Silicon photodiode and an integrated circuit. The IC contains an LED driver, amplifiers and a quantizer.

The module is designed to interface directly with selected I/O chips that incorporate logic which performs pulse width modulation/demodulation.

### Schematic

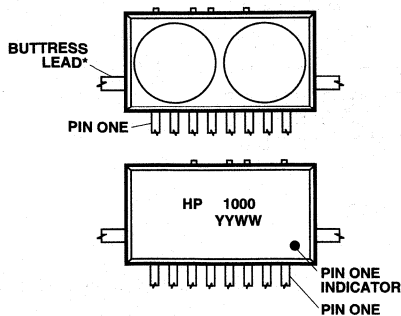

\* SIDE BUTTRESS LEADS ARE FOR MECHANICAL STABILITY AND SHOULD NOT BE CONNECTED TO ANY ELECTRICAL POTENTIAL.

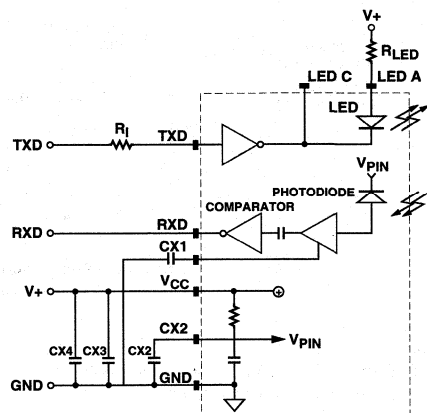

# Package Dimensions

Option X01\*

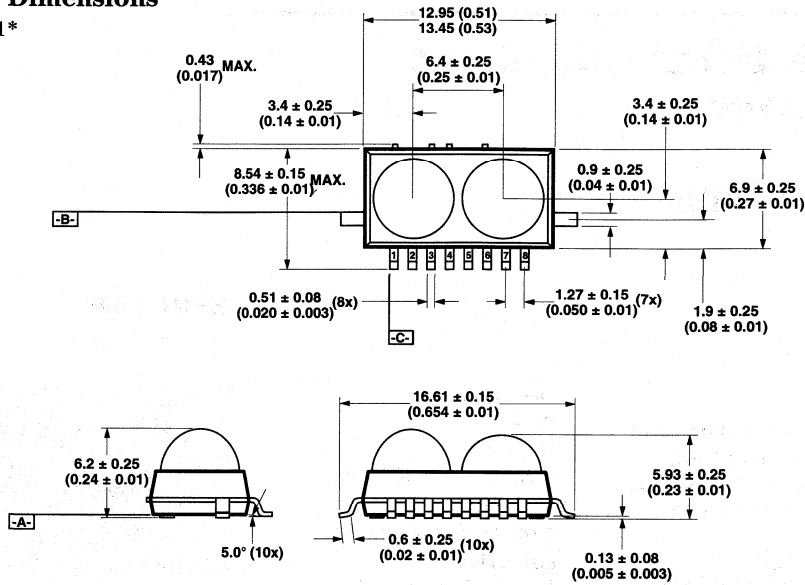

DIMENSIONS IN MILLIMETERS (INCHES).

Option X02\*

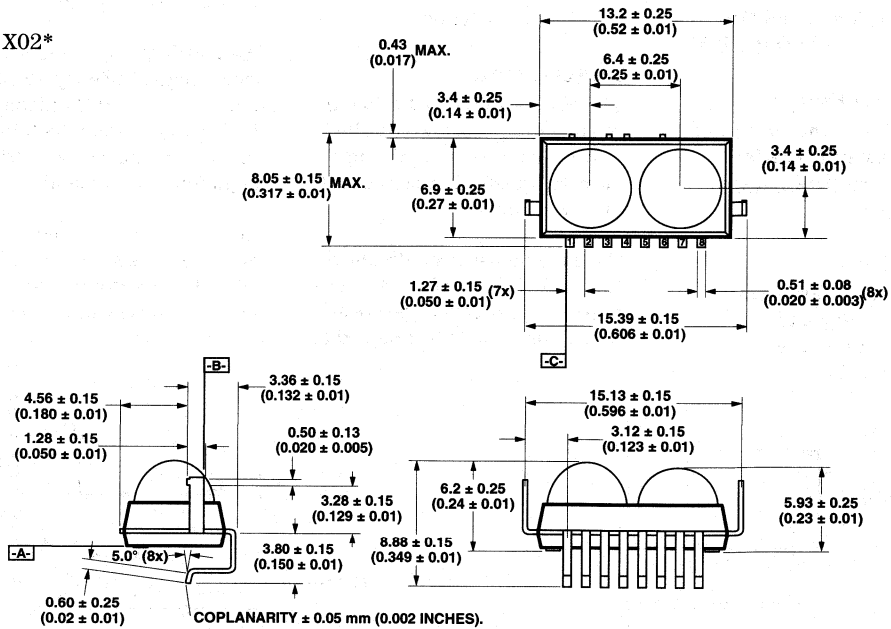

COPLANARITY ± 0.05 mm (0.002 INCHES).

DIMENSIONS IN MILLIMETERS (INCHES).

## Note:

The -B- datum is formed by the two highest points of the combined surface formed by this surface and the corresponding surface of the same lead on the opposite side of the package.

\*X position indicates packaging. 0 = tape and reel, 1 = JEDEC standard tray.

# Package Dimensions (continued)

Option X03\*

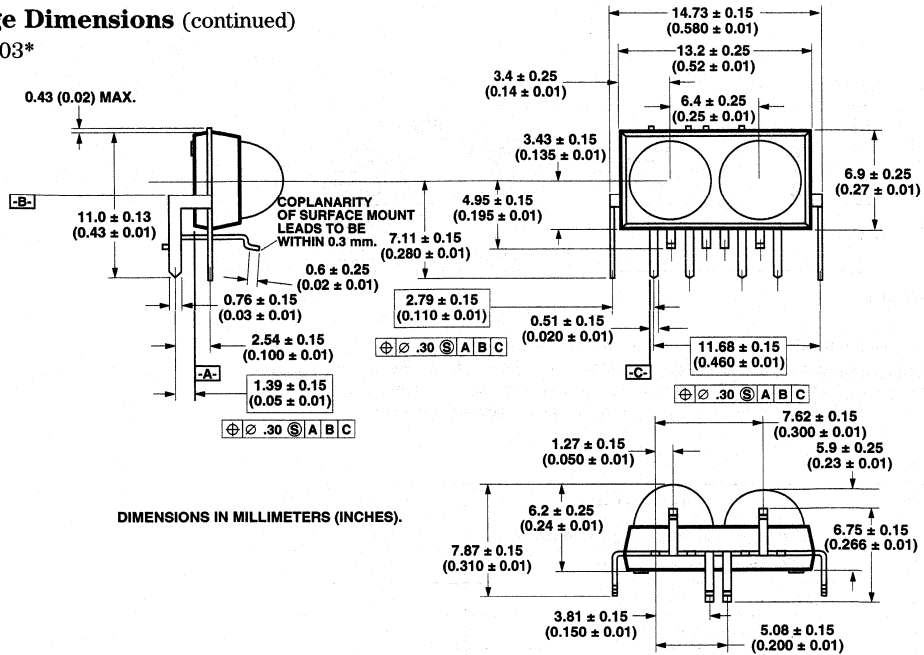

Option X04\*

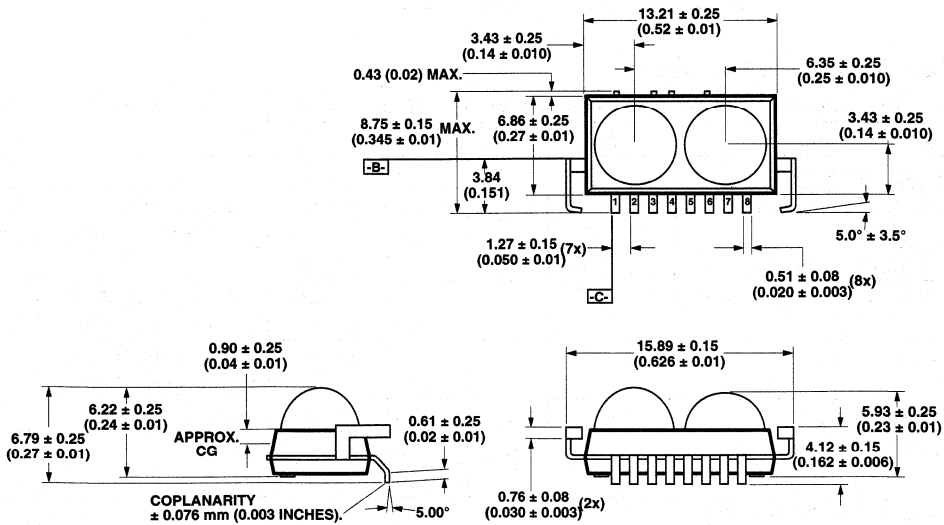

**Note:**

The -B- datum is formed by the two highest points of the combined surface formed by this surface and the corresponding surface of the same lead on the opposite side of the package.

\*X position indicates packaging. 0 = tape and reel, 1 = JEDEC standard tray.

INFRARED PRODUCTS

## Truth Table

Inputs		LED	Outputs	
TXD	EI <sup>[1]</sup>		LEDA	RXD
V <sub>IH</sub>	X	ON	Low	Low <sup>[2]</sup>
V <sub>IL</sub>	EI <sub>H</sub>	OFF	High	Low <sup>[2]</sup>
V <sub>IL</sub>	EI <sub>L</sub>	OFF	High	High

X = Don't care.

### Notes:

1. EI – received in band light intensity present at detector surface.
2. Logic Low is a pulsed response. A receiver output low state V<sub>OL</sub> (RXD) is not indefinitely maintained, but is instead a pulsed response. The output low state is maintained for a duration dependent on the incident bit pattern and the incident intensity (EI).

## Pinout

Pin	Description	Symbol
1	Daylight Cancellation Capacitor	CX1
2	PIN Bypass Capacitor	CX2
3	Supply Voltage	V <sub>CC</sub>
4	Receiver Data Output	RXD
5	Ground	Gnd
6	Transmitter Data Input	TXD
7	LED Cathode	LEDC
8	LED Anode	LEDA

## Absolute Maximum Ratings

Parameter	Symbol	Min.	Max.	Units	Conditions	Fig.
Storage Temperature	T <sub>S</sub>	-20	85	C		
Operating Temperature	T <sub>A</sub>	0	70	C		
Lead Solder Temperature			260	C	For 10 s (1.6 mm below seating plane)	Reflow Profile
Average LED Current	I <sub>LED</sub> (DC)		100	mA		
Repetitive Pulsed LED Current	I <sub>LED</sub> (PK)		500	mA	≤ 90 μs Pulse Width, ≤ 20% Duty Cycle	
Peak LED Current	I <sub>LED</sub> (RP)		1.0	A	≤ 2 μs Pulse Width, ≤ 10% Duty Cycle	
LED Anode Voltage	V <sub>LEDA</sub>	-0.5	7.0	V		
LED Cathode Voltage	V <sub>LEDC</sub>	-0.5	V <sub>LEDA</sub>	V		
Supply Voltage	V <sub>CC</sub>	0	7.0	V		
Transmitter Data Input Voltage	V <sub>TXD</sub>	-0.5	5.5	V		
Receiver Data Output Voltage	V <sub>RXD</sub>	-0.5	V <sub>CC</sub> + 0.5	V		

## Infrared Reflow Profile

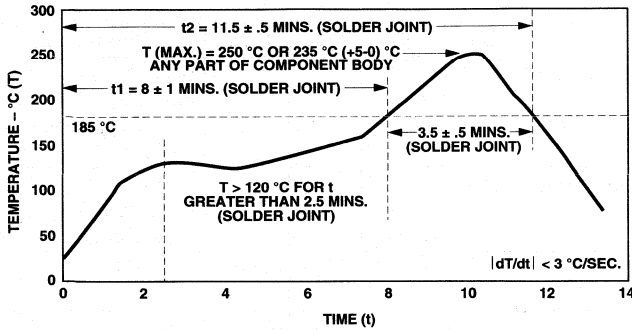

## Recommended Operating Conditions

Parameter	Symbol	Min.	Max.	Units	Conditions
Operating Temperature	$T_A$	0°	70°	C	
Supply Voltage	$V_{CC}$	4.5	5.5	V	
Logic High Transmitter Input Voltage	$V_{IH}$ (TXD)	2.5	5.5	V	
Logic Low Transmitter Input Voltage	$V_{IL}$ (TXD)	0.0	0.3	V	
Logic High Receiver Input Irradiance (870 nm)	$E_{IH}$	0.0036	500	mW/cm <sup>2</sup>	For in-band signals*
Logic Low Receiver Input Irradiance	$E_{IL}$		0.3	μW/cm <sup>2</sup>	For in-band signals*
LED (Logic High) Current Pulse Amplitude	$I_{LEDA}$	250		mA	For one metre links with daylight filters
Receiver Set-up Time		10		ms	For full sensitivity after transmitting
Signal Rate		2.4	116	Kp/s	
Ambient Light					See IrDA Serial Infrared Physical Layer Link Specification, Appendix A for ambient levels. See Rx TH+ section at the end of this data sheet also.

\*Note: An in-band optical signal is a pulse/sequence where the peak wavelength,  $\lambda_p$ , is defined as  $850 \text{ nm} \leq \lambda_p \leq 900 \text{ nm}$ , the pulse repetition rate, PRR, is defined as  $2.4 \text{ Kp/s} \leq \text{PRR} \leq 115.2 \text{ Kp/s}$  and the pulse width, PW, is defined as  $1.6 \text{ s} \leq \text{PW} \leq (3/16)/\text{PRR}$ .

## Electrical & Optical Specifications

Specifications hold over the Recommended Operating Conditions unless otherwise noted. Test Conditions represent worst case values for the parameters under test. Unspecified test condition can be anywhere in their recommended operating range. All typicals are at 25°C and 5V unless otherwise noted.

Parameter		Symbol	Min.	Typ.	Max.	Unit	Conditions	Fig.
Receiver Data Output Voltage	Logic Low <sup>[2]</sup>	$V_{OL} (RXD)^{[2,3]}$			0.4	V	$I_O = 0.3 \text{ mA}$ For In-Band $EI \geq 3.6 \mu\text{W}/\text{cm}^2$ ; $\theta \leq 15^\circ$	
	Logic High	$V_{OH} (RXD)$	$V_{CC} - 0.5$			V	$I_O = -20 \mu\text{A}$ , For In-Band $EI \leq 0.3 \mu\text{W}/\text{cm}^2$	
Effective Detector Area				0.2		$\text{cm}^2$		
Transmitter Radiant Intensity	Logic Low	$IE_L$			0.3	$\mu\text{W}/\text{SR}$	$V_I \leq 0.3 \text{ V}$	
	Logic High Intensity	$IE_H$	44		250	$\text{mW}/\text{SR}$	$I_{LEDA} = 250 \text{ mA}$ , $V_I = 2.5 \text{ V}$ , $\theta \leq 30^\circ$	4, 6
					40	$\text{mW}/\text{SR}$	$I_{LEDA} = 250 \text{ mA}$ , $V_I = 2.5 \text{ V}$ ; $\theta > 60^\circ$	
	Peak Wavelength	$\lambda_p$		875		nm		6
Spectral Line Half Width	$\Delta\lambda_{1/2}$		35		nm		6	
Transmitter	Viewing Angle	$\theta$	30		60	$^\circ$		7
Receiver		$\phi$	30			$^\circ$		
Transmitter Data Input Current	Logic Low	$I_{IL}(\text{TXD})$	-1.0		1.0	$\mu\text{A}$	$\text{Gnd} \leq V_I \leq 0.3 \text{ V}$	
	Logic High	$I_{IH}(\text{TXD})$	4.5			mA	$V_I = 2.5 \text{ V}$	1
LED Anode On State Voltage	$V_{ON} (\text{LEDA})$				2.50	V	$I_{LEDA} = 250 \text{ mA}$ , $T_j = 25^\circ\text{C}$	1, 3
LED Anode Off State Leakage	$I_{LK} (\text{LEDA})$				100	$\mu\text{A}$	$V_{LEDA} = V_{CC} = 5.5 \text{ V}$ , $V_I = 0.3\text{V}$	
Supply Current TXD High	ICC1				1.1	mA	$V_{CC} = 5.5$ , $V_I (\text{TXD}) = V_{IH}$ , $I_{LED} = 250 \text{ mA}$ , $EI = 0$	11
Supply Current RXD Low <sup>[2]</sup>	ICC2				13	mA	$V_{CC} = 5.5$ , $V_I (\text{TXD}) = V_{IL}$ , $EI = 500 \text{ mW}/\text{cm}^2$	1
Receiver Peak Sensitivity Wavelength	$\lambda_p$			880		nm		9

### Notes:

- EI – received in band light intensity present at detector surface.
- Pulsed Response – Logic Low is a pulsed response. A receiver output low state  $V_{OL} (RXD)$  is not indefinitely maintained but is instead a pulsed response. The output low state is maintained for a duration dependent on the incident bit pattern and incident intensity (EI).
- The  $EI \geq 3.6 \mu\text{W}/\text{cm}^2$  condition guarantees the IrDA minimum receiver sensitivity of  $4.0 \mu\text{W}/\text{cm}^2$  while allowing for 10% light loss through a cosmetic window placed in front of the HSDL-1000. (See the Rx TH+ section at the end of this data sheet for information on receiver sensitivity over temperature, and in the presence of ambient light.)



## Switching Specifications

Specifications hold over the Recommended Operating Conditions unless otherwise noted. Test Conditions represent worst case values for the parameters under test. Unspecified test conditions can be anywhere in their recommended operating range. All typicals are at 25°C and 5V unless otherwise noted.

Parameter	Symbol	Min.	Typ.	Max.	Units	Conditions	Fig.
Transmitter Turn On Time			0.1		μs	I <sub>LED</sub> = 250 mA, 1.6 μs PW	13, 14
Transmitter Turn Off Time			0.4	1.0	μs		
Transmitter Rise Time				0.6	μs		
Transmitter Fall Time				0.6	μs		
Receiver Turn On Time			0.4		μs	EI = 3.6 μW/cm <sup>2</sup> , 1.6 μs PW	15, 16
Receiver Turn Off Time				5.4	μs	EI = 500 mW/cm <sup>2</sup> , 1.6 μs PW	
Receiver Rise Time			1.0		μs		
Receiver Fall Time			0.02		μs	EI = 3.6 μW/cm <sup>2</sup> , 1.6 μs PW	
Receiver Recovery Time				10	ms		

## Application Circuit

Component	Recommended Value
R <sub>i</sub>	300 Ohms ± 5%
R <sub>LED</sub>	8.0 Ohms maximum
CX1	0.22 μF ± 10%
CX2	0.4 μF minimum
CX3	0.10 μF ± 22%. Low inductance is critical
CX4	4.7 μF minimum. Larger value is recommended for noisy supplies or environments.

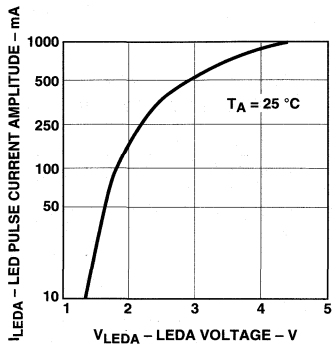

Figure 1. LED Pulse Current Amplitude vs. LED Voltage.

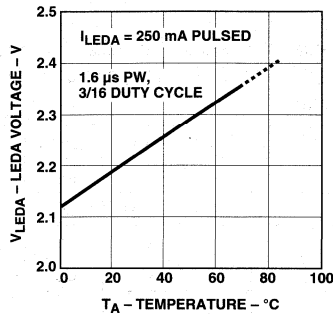

Figure 2. LED Voltage vs. Temperature.

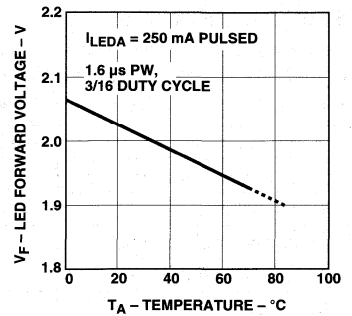

Figure 3. LED Forward Voltage vs. Temperature.

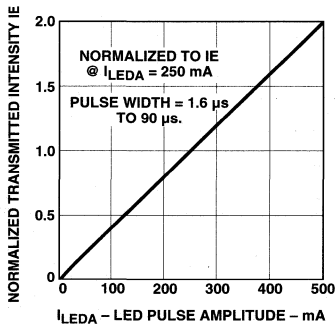

Figure 4. Transmitted Intensity vs. LED Pulse Amplitude.

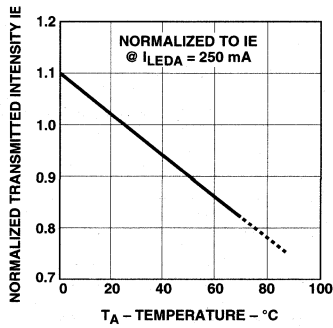

Figure 5. Transmitted Intensity vs. Temperature.

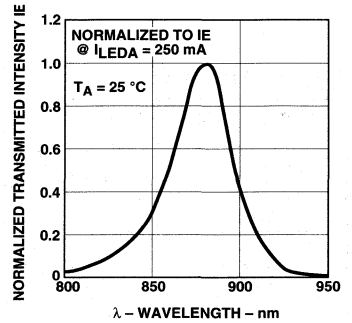

Figure 6. Transmitted Intensity vs. Wavelength.

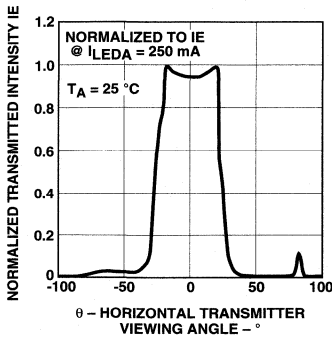

Figure 7. Transmitted Intensity vs. Horizontal Viewing Angle.

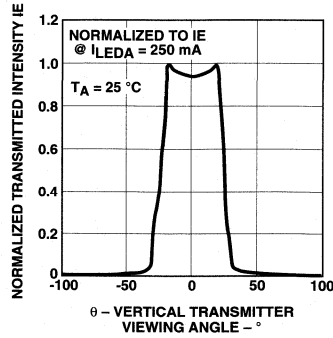

Figure 8. Transmitted Intensity vs. Vertical Viewing Angle.

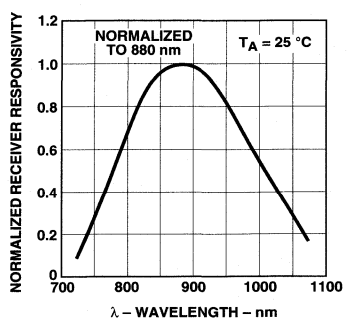

Figure 9. Receiver Responsivity vs. Wavelength.

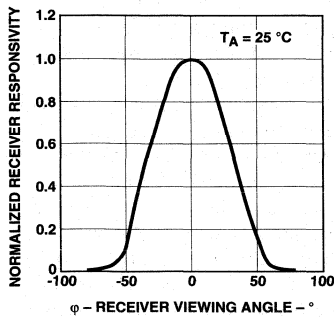

Figure 10. Receiver Responsivity vs. Viewing Angle.

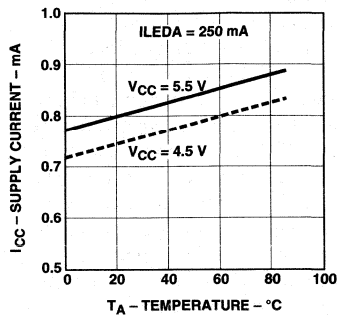

Figure 11. Supply Current vs. Temperature.

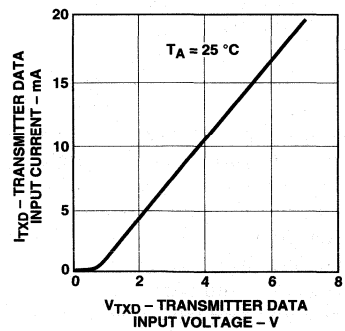

Figure 12. Data Input Current vs. Data Input Voltage.

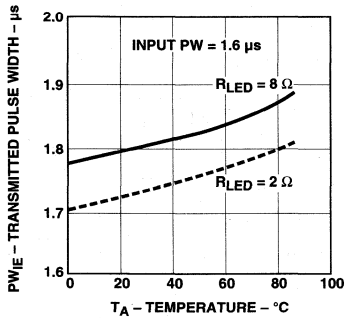

Figure 13. Transmitted Pulse Width vs. Temperature.

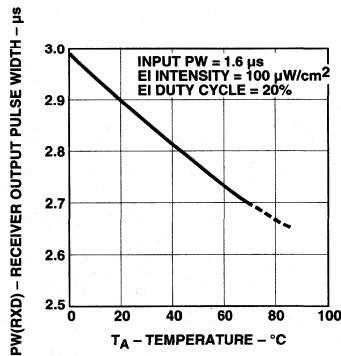

Figure 14. Transmitted Pulse Width vs. Temperature.

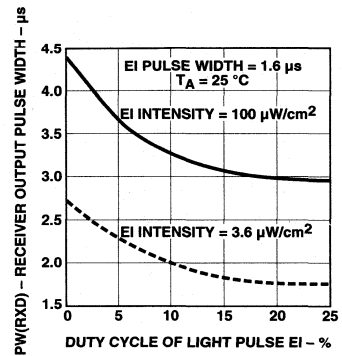

Figure 15. Receiver Output Pulse Width vs. Duty Cycle of Received Signal.

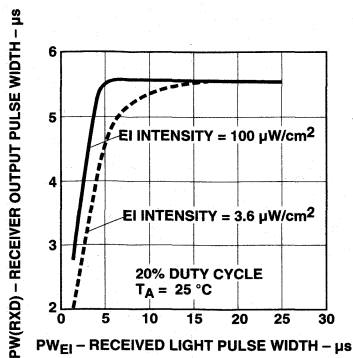

Figure 16. Receiver Output Pulse Width vs. Received Light Pulse Width.

### Rx TH+ (Receiver On-Threshold)

The maximum receiver on-threshold is equivalent to the minimum receiver sensitivity. Both are terms for the amount of light signal which must be present at the HSDL-1000 detector in order to trigger a low pulse on the receiver output (RXD). The IrDA Physical Layer Specification requires a minimum receiver sensitivity of  $4.0 \mu\text{W}/\text{cm}^2$ , at a Bit Error Rate of  $10^{-9}$ , and in the presence of the 10 klux of sunlight, 0-1000 lux of fluorescent

light, or 0-1000 lux of incandescent light. The fluorescent and incandescent specifications require minimum receiver sensitivity with 1000 lux incident onto the horizontal surface of the IR link. The resulting amount of fluorescent or incandescent light actually reaching the detector surface may vary between 0 and 500 lux depending upon the design of the housing around the HSDL-1000 module.

The HSDL-1000  $V_{OL}(\text{RXD})$  specification guarantees a maximum receiver on-threshold of  $EI = 3.6 \mu\text{W}/\text{cm}^2$ , at a  $\text{BER} \leq 10^{-9}$ , and  $T_A = 0-70^\circ\text{C}$ . The  $EI = 3.6 \mu\text{W}/\text{cm}^2$  threshold guarantees the IrDA minimum receiver sensitivity of  $4.0 \mu\text{W}/\text{cm}^2$ , while allowing for 10% light loss through a cosmetic window placed in front of the HSDL-1000. The  $EI = 3.6 \mu\text{W}/\text{cm}^2$  threshold also guarantees receiver sensitivity with 10 klux of sunlight, 0-500 lux fluorescent light, or 0-500 lux of incandescent light incident on the HSDL-1000 detector surface.

### HSDL-1000 Reliability Test Results

Test Name	MIL-STD-883 Reference	Test Conditions	Units Tested	Total Failed
Solder Heat (IR Profile)		See absolute profile	60	0
Solder Heat Resistance		3 times thru IR Profile + 20 Temp. Cycles	60	0
Solder Rework Cycle		Solder iron tip temp. $370^\circ\text{C}/700^\circ\text{F}$ Time per lead 1 second # of rework cycles = 4	17	0
Temperature Cycle	1010	$-40^\circ\text{C}$ to $+100^\circ\text{C}$ , Dwell = 15 Minutes Transfer = 5 Minutes		
		20 Cycles	120	0
		100 Cycles	120	0
Power Temp. Cycle		$-40^\circ\text{C}/+100^\circ\text{C}$ , Dwell = 15 minutes, Transfer = 5 Minutes, $V_{CC} = 5 \text{ Vdc}$ , If = 100 mAdc, LED On/Off = 1 Second Total Cycles = 35	60	0
Mechanical Shock	2002 Condition B	2 Blows each X1, X2, Y1, Y2, Z1, Z2 1500 G's, 0.5 msec Pulse	10	0
Vibration Variable Frequency	2007 Condition A	(4) 4 Minute Cycles, X, Y, Z at 50 G's Min., 20 to 2,000 Hz	10	0
Resistance to Solvents	2015	3 one minute immersion Brush after solvent	20	0
High Temp. Operating Life		$T_A = 70^\circ\text{C}$ , If = 100 mAdc, $V_{CC} = 5 \text{ Vdc}$ , Time = 500 hours	60	0
Low Temp. Operating Life		$T_A = 0^\circ\text{C}$ , If = 100 mAdc, $V_{CC} = 5 \text{ Vdc}$ Time = 500 hours	60	0
Wet Operating Life		$T_A = 35^\circ\text{C}$ , R.H. = 85% If = 100 mAdc $V_{CC} = 5 \text{ Vdc}$ , Time = 500 hours	60	0
ESD - Human Body Model	3015	RI = 1500 Ohms, C = 100 $\mu\text{F}$ Level = 4000 V	10	0
ESD - Machine Model	EIAJ	Rload = 0 Ohms, C = 200 $\mu\text{F}$ Level = 300 V	10	0

**Note:** At the time of this publication, Light Emitting Diodes (LEDs) that are contained in this product are regulated for eye safety in Europe by the Commission for European Electrotechnical Standardization (CENELEC) EN60825-1. Please refer to Application Briefs I-008, I-009, I-015 for more information.

# IR 3/16 Encode/Decode IC

## Technical Data

### Features

- **Compliant with IrDA Physical Layer Specs**
- **Interfaces with IrDA Compliant HSDL-1000 IR Transceiver**
- **1 Micron CMOS Gate Array**
- **Used in Conjunction with Standard 16550 UART**
- **Pin Compatible with PLX-1000**

### Applications

#### Interfaces with HSDL-1000 to perform:

- **Serial Half-Duplex Data Transfer Between:**
  - Notebook Computers
  - Subnotebooks
  - Desktops PCs
  - PDAs
  - Printers
  - Other Peripheral Devices
- **Telecom Applications in:**
  - Modems
  - Fax Machines
  - Pagers
  - Phones
- **Industrial Applications in:**
  - Data Collection Devices
- **Medical Applications in:**
  - Patient and Pharmaceutical Data Collection

### Description

The HSDL-7000 performs the modulation/demodulation function used to both encode and decode the electrical pulses from the IR transceiver. These pulses are then sent to a standard UART which has a BAUDOUT signal available externally. This signal is 16 times the selected baud rate. In applications where the 16XCLK is not available, an external means of generating the 16XCLK must be designed.

The HSDL-7000 is comprised of two state machines – the serial IR encode and the serial IR decode blocks. Each of these blocks derives their timing from the 16XCLK input signal from the UART. The Encode block is driven by the negative edge triggered TXD signal from the UART. This initiates the modulation state machine resulting in the 3/16 modulated IR\_TXD signal which drives the IR transceiver module, HSDL-1000. The IR Decode block is driven by the negative edge triggered IR\_RCV signal from the HSDL-1000. After this signal is demodulated and stretched, it drives the RCV signal to the UART.

## HSDL-7000

### Schematic

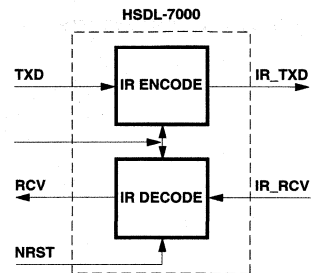

### Pin Out

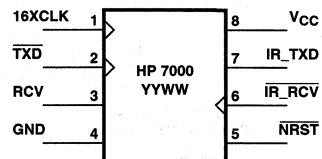

## Pin Description

**16XCLK** - Positive edge triggered input clock that is set to 16 times the data transmission baud rate. The encode and decode schemes require this signal. The signal is usually tied to a UART's BAUDOUT signal.

**TXD** - Negative edge triggered input signal; usually tied to a UART's SOUT signal (serial data to be transmitted).

**RCV** - Output signal which is usually tied to a UART's SIN signal (received serial data).

**GND** - Chip ground.

**NRST** - Active low signal used to reset the decode state machine. This signal can be tied to POR (Power on reset) or  $V_{CC}$ . This signal can also be used to disable any data reception.

**IR\_RCV** - A 3/16th pulse width input signal from the HSDL-1000. The signal is a demodulated (pulse stretched) to generate the RCV output signal.

**IR\_TXD** - This signal is the modulated 3/16ths TXD signal which is input to the HSDL-1000.

**V<sub>CC</sub>** - Power.

## Package Dimensions

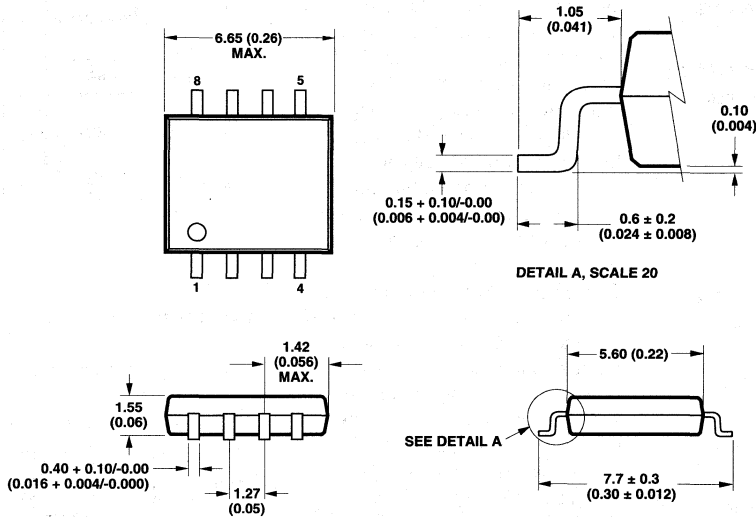

NOTE: DIMENSIONS IN MILLIMETERS (INCHES).

### Encoding Scheme

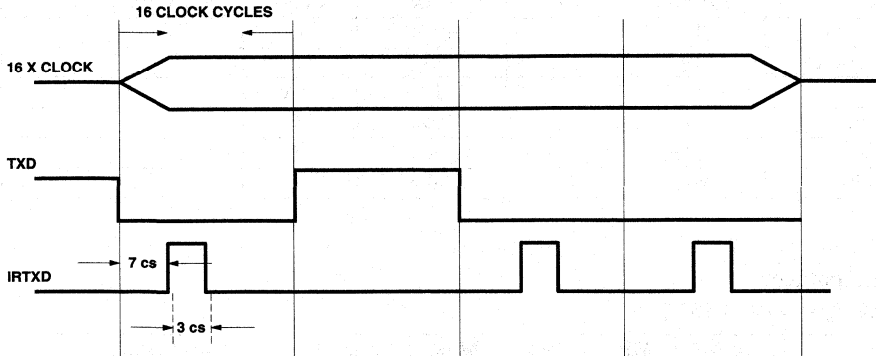

The encoder sends a pulse for every space or "0" that is sent on the TXD line. On a high to low transition of the TXD line, the generation of the pulse is delayed

for 7 clock cycles of the 16XCLK before the pulse is set high for 3 clock cycles (or 3/16th of a bit time) and then subsequently pulled low.

### Decoding Scheme

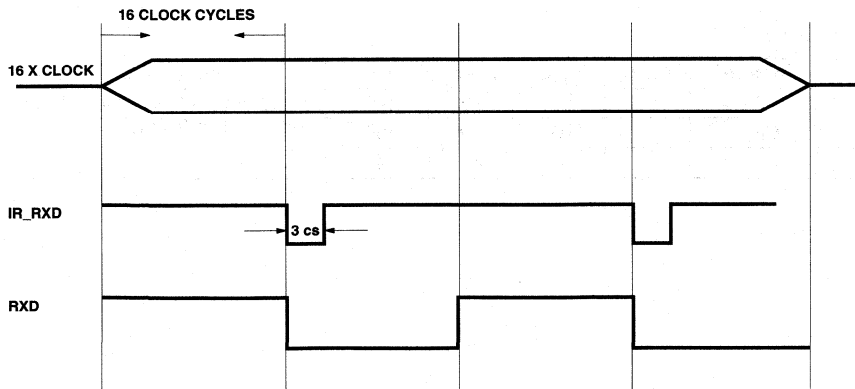

A high to low transition of the IR\_RXD line from the HSDL-1000 signifies a 3/16th pulse. This pulse is stretched to accommodate 1 bit time (16 clock cycles). Every pulse that is received is

translated into a "0" or space on the RXD line equal to 1 bit time.

Note: The stretched pulse must be at least 3/4 of a bit time in duration to be correctly interpreted by a UART.

### Absolute Maximum Ratings

Parameter	Symbol	Min.	Max.	Units	Conditions
Storage Temperature	$T_S$	-65	+150	°C	
Operating Temperature	$T_A$	-40	+85	°C	
Output Current	$I_O$		10	mA	
Power Dissipation	$P_{MAX}$		0.22	W	
Input/Output Voltage	$V_I/V_O$	-0.5	$V_{CC} + 0.5$	V	
Power Supply Voltage	$V_{CC}$	-0.5	+6.5	V	

### Switching Specifications

( $V_{CC} = 5 \text{ Volts} \pm 10\%$ ,  $T_A = -40 \text{ to } +85^\circ\text{C}$ )

Parameter	Symbol	Min.	Typ.	Max.	Units	Conditions
Toggle Frequency	$f_{tog}$		120		Mhz	
Propagation Delay Time	$t_{pd}$		0.5		ns	Internal Gate
			1.0		ns	Input Buffer
			2.0		ns	Output Buffer
Output Fall Time	$t_f$		1.42		ns	Output Buffer ( $C_L = 15 \text{ pF}$ )
Output Rise Time	$t_r$		1.54		ns	Output Buffer ( $C_L = 15 \text{ pF}$ )

Note:  $f_{tog}$  represents the maximum internal D-Type Flip Flop toggle rate

### Capacitance

( $V_{CC} = 0 \text{ Volts}$ ,  $T_A = -40 \text{ to } +85^\circ\text{C}$ )

Parameter	Symbol	Min.	Typ.	Max.	Units	Conditions
Input Capacitance	$C_{IN}$		10	20	pF	f = 1 MHz - Unmeasured Pins Returned to 0 Volts
Output Capacitance	$C_{OUT}$		10	20	pF	
Output Fall Time			10	20	pF	



## Recommended Operating Conditions

( $T_A = -40$  to  $+85^\circ\text{C}$ )

Parameter	Symbol	Min.	Typ.	Max.	Units	Conditions
Supply Voltage	$V_{CC}$	2.7	5.0	5.5	V	CMOS level
Input Voltage	$V_I$	0.0		$V_{CC}$	V	CMOS level
Ambient Temperature	$T_A$	-40		+85	$^\circ\text{C}$	CMOS level
High Level Input Voltage	$V_{IH}$	$0.7 V_{CC}$		$V_{CC}$	V	CMOS level
Low Level Input Voltage	$V_{IL}$	0.0		$0.3 V_{CC}$	V	CMOS level
Positive Trigger Voltage	$V_P$	1.61		4.00	V	CMOS level
Negative Trigger Voltage	$V_N$	0.55		3.10	V	CMOS level
Hysteresis Voltage	$V_H$	0.50		2.00	V	CMOS level
Power Dissipation	$P_{DISS}$		4.9	220	mW	$f_{16XCLK} = 2$ MHz
Input Rise Time	$t_{ri}$			200	ns	$f_{16XCLK} = 2$ MHz
Input Fall Time	$t_{fa}$			200	ns	$f_{16XCLK} = 2$ MHz
Max Clk Frequency (16XCLK)	$f_{16XCLK}$			2	MHz	
Minimum Pulse Width (IR_TXD)*	$t_{mpx}$	250			ns	$f_{16XCLK} = 2$ MHz

\*IrDA Parameters. The Max Clk Frequency represents the maximum clock frequency to drive the HSDL-7000's internal state machine. Under normal circumstances, this clock input should not exceed  $16 * 115.2$  Kbp/s or 1.8432 MHz. This product can operate at higher clock rates, but the above is the recommended rate.

The Minimum Pulse Width represents the minimum pulse width of the encoded IR\_TXD pulse (and the IR\_RCV pulse). As per the IrDA specifications, the minimum pulse width of the IR\_TXD and IR\_RCV pulses should be  $3 * (1/1.8432 \text{ MHz})$  or  $1.63 \mu\text{s}$ . The minimum pulse width specified for the HSDL-7000 is 250 ns, which is within IrDA specification. Under normal circumstances, the pulse width should not be less than  $1.63 \mu\text{s}$ .

## Application Circuits

HSDL-7000 Connection to UART

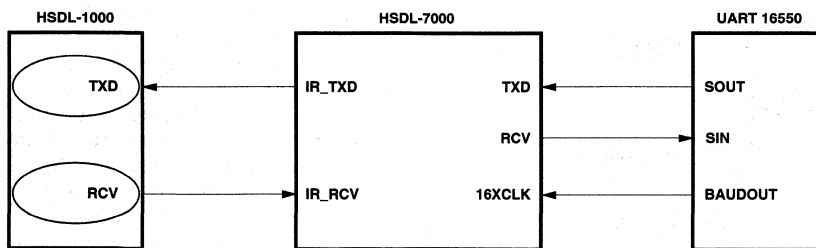

**Note:** At the time of this publication, Light Emitting Diodes (LEDs) that are contained in this product are regulated for eye safety in Europe by the Commission for European Electrotechnical Standardization (CENELEC) EN60825-1. Please refer to Application Briefs I-008, I-009, I-015 for more information.

# High-Performance T-1<sup>3/4</sup> (5 mm) TS AlGaAs Infrared (875 nm) Lamp

## Technical Data

**HSDL-4200 Series**  
**HSDL-4220 30°**  
**HSDL-4230 17°**

### Features

- Very High Power TS AlGaAs Technology
  - 875 nm Wavelength
  - T-1<sup>3/4</sup> Package
  - Low Cost
  - Very High Intensity:  
 HSDL-4220 - 38 mW/sr  
 HSDL-4230 - 75 mW/sr
  - Choice of Viewing Angle:  
 HSDL-4220 - 30°  
 HSDL-4230 - 17°
  - Low Forward Voltage for Series Operation
  - High Speed: 40 ns Rise Times
- Copper Leadframe for Improved Thermal and Optical Characteristics

### Applications

- Compatible with IrDA SIR Standard
- IR Audio
- IR Telephones
- High Speed IR Communications  
 IR LANs  
 IR Modems  
 IR Dongles
- Industrial IR Equipment

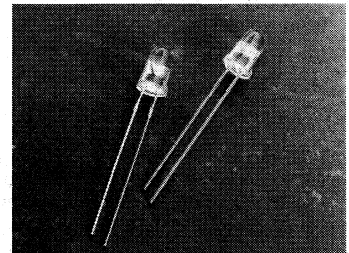

- IR Portable Instruments
- Interfaces with Crystal Semiconductor CS8130 Infrared Transceiver

### Package Dimensions

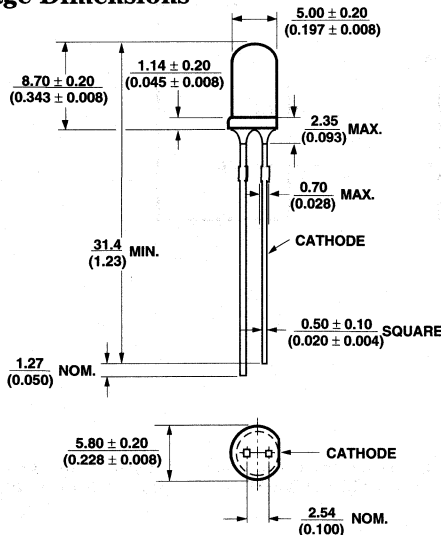

### Description

The HSDL-4200 series of emitters are the first in a sequence of emitters that are aimed at high power, low forward voltage, and high speed. These emitters utilize the Transparent Substrate, double heterojunction, Aluminum Gallium Arsenide (TS AlGaAs) LED technology. These devices are optimized for speed and efficiency at emission wavelengths of 875 nm. This material produces high radiant efficiency over a wide range of currents up to 500 mA peak current. The HSDL-4200 series of emitters are available in a choice of viewing angles, the HSDL-4230 at 17° and the HSDL-4220 at 30°. Both lamps are packaged in clear T-1<sup>3/4</sup> (5 mm) packages.

The package design of these emitters is optimized for efficient power dissipation. Copper leadframes are used to obtain better thermal performance than the traditional steel leadframes.

The wide angle emitter, HSDL-4220, is compatible with the IrDA SIR standard and can be used with the HSDL-1000 integrated SIR transceiver.

## Absolute Maximum Ratings

Parameter	Symbol	Min	Max	Unit	Reference
Peak Forward Current	$I_{FPK}$		500	mA	[2], Fig. 2b Duty Factor = 20% Pulse Width = 100 $\mu$ s
Average Forward Current	$I_{FAVG}$		100	mA	[2]
DC Forward Current	$I_{FDC}$		100	mA	[1], Fig. 2a
Power Dissipation	$P_{DISS}$		260	mW	
Reverse Voltage ( $I_R = 100 \mu$ A)	$V_R$	5		V	
Transient Forward Current (10 $\mu$ s Pulse)	$I_{FTR}$		1.0	A	[3]
Operating Temperature	$T_O$	0	70	$^{\circ}$ C	
Storage Temperature	$T_S$	-20	85	$^{\circ}$ C	
LED Junction Temperature	$T_J$		110	$^{\circ}$ C	
Lead Soldering Temperature [1.6 mm (0.063 in.) from body]			260 for 5 seconds	$^{\circ}$ C	

### Notes:

- Derate linearly as shown in Figure 4.
- Any pulsed operation cannot exceed the Absolute Max Peak Forward Current as specified in Figure 5.
- The transient peak current is the maximum non-recurring peak current the device can withstand without damaging the LED die and the wire bonds.

## Electrical Characteristics at 25 $^{\circ}$ C

Parameter	Symbol	Min	Typ	Max	Unit	Condition	Reference
Forward Voltage	$V_F$	1.30	1.50	1.70	V	$I_{FDC} = 50$ mA	Fig. 2a
		1.40	1.67	1.85		$I_{FDC} = 100$ mA	Fig. 2b
			2.15			$I_{FPK} = 250$ mA	
Forward Voltage Temperature Coefficient	$\Delta V/\Delta T$		-2.1		mV/ $^{\circ}$ C	$I_{FDC} = 50$ mA $I_{FDC} = 100$ mA	Fig. 2c
Series Resistance	$R_S$		2.8		ohms	$I_{FDC} = 100$ mA	
Diode Capacitance	$C_O$		40		pF	0 V, 1 MHz	
Reverse Voltage	$V_R$	5	20		V	$I_R = 100 \mu$ A	
Thermal Resistance, Junction to Pin	$R\theta_{jp}$		110		$^{\circ}$ C/W		

### Optical Characteristics at 25°C

Parameter	Symbol	Min	Typ	Max	Unit	Condition	Reference
Radiant Optical Power HSDL-4220	$P_O$		19 38		mW	$I_{FDC} = 50 \text{ mA}$ $I_{FDC} = 100 \text{ mA}$	
HSDL-4230	$P_O$		16 32		mW	$I_{FDC} = 50 \text{ mA}$ $I_{FDC} = 100 \text{ mA}$	
Radiant On-Axis Intensity HSDL-4220	$I_E$	22	38 76 190	60	mW/sr	$I_{FDC} = 50 \text{ mA}$ $I_{FDC} = 100 \text{ mA}$ $I_{FPK} = 250 \text{ mA}$	Fig. 3a Fig. 3b
HSDL-4230	$I_E$	39	75 150 375	131	mW/sr	$I_{FDC} = 50 \text{ mA}$ $I_{FDC} = 100 \text{ mA}$ $I_{FPK} = 250 \text{ mA}$	Fig. 3a Fig. 3b
Radiant On-Axis Intensity Temperature Coefficient	$\Delta I_E/\Delta T$		-0.35 -0.35		%/°C	$I_{FDC} = 50 \text{ mA}$ $I_{FDC} = 100 \text{ mA}$	
Viewing Angle HSDL-4220	$2\theta_{1/2}$		30		deg	$I_{FDC} = 50 \text{ mA}$	Fig. 6
HSDL-4230	$2\theta_{1/2}$		17		deg	$I_{FDC} = 50 \text{ mA}$	Fig. 7
Peak Wavelength	$\lambda_{PK}$	860	875	895	nm	$I_{FDC} = 50 \text{ mA}$	Fig. 1
Peak Wavelength Temperature Coefficient	$\Delta\lambda/\Delta T$		0.25		nm/°C	$I_{FDC} = 50 \text{ mA}$	
Spectral Width—at FWHM	$\Delta\lambda$		37		nm	$I_{FDC} = 50 \text{ mA}$	Fig. 1
Optical Rise and Fall Times, 10%-90%	$t_r/t_f$		40		ns	$I_{FDC} = 50 \text{ mA}$	
Bandwidth	$f_c$		9		MHz	$I_F = 50 \text{ mA}$ $\pm 10 \text{ mA}$	Fig. 8

### Ordering Information

Part Number	Lead Form	Shipping Option
HSDL-4220	Straight	Bulk
HSDL-4230	Straight	Bulk

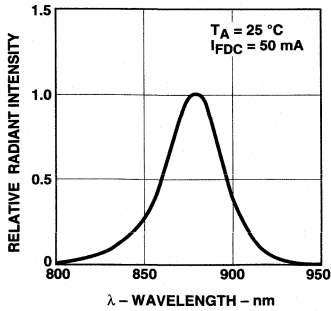

Figure 1. Relative Radiant Intensity vs. Wavelength.

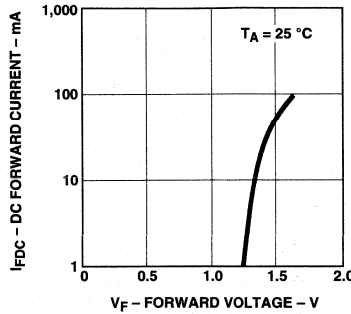

Figure 2a. DC Forward Current vs. Forward Voltage.

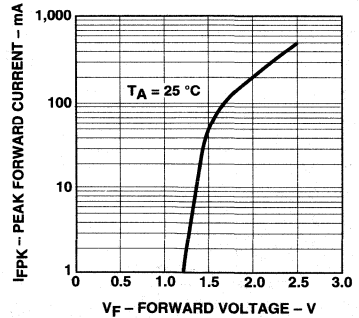

Figure 2b. Peak Forward Current vs. Forward Voltage.

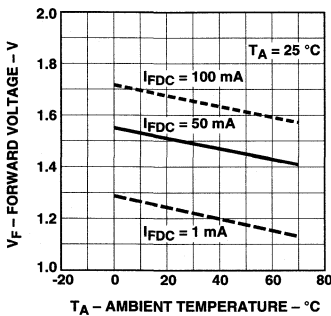

Figure 2c. Forward Voltage vs. Ambient Temperature.

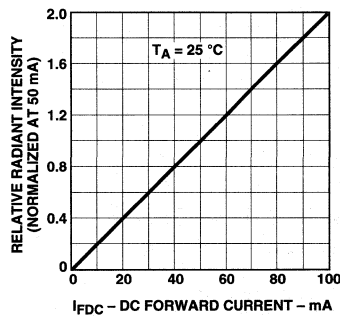

Figure 3a. Relative Radiant Intensity vs. DC Forward Current.

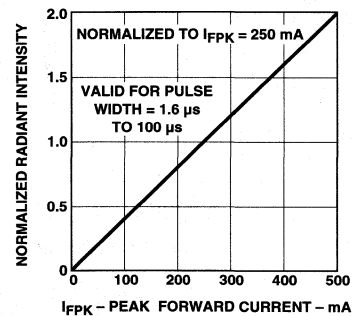

Figure 3b. Normalized Radiant Intensity vs. Peak Forward Current.

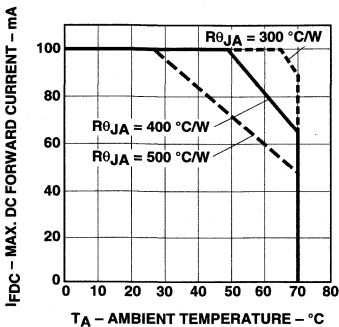

Figure 4. Maximum DC Forward Current vs. Ambient Temperature. Derated Based on  $T_{JMAX} = 110^{\circ}C$ .

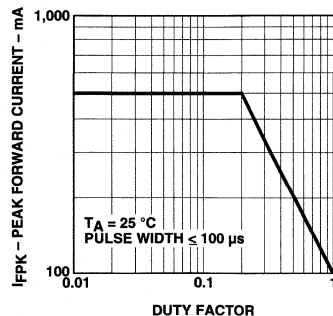

Figure 5. Maximum Peak Forward Current vs. Duty Factor.

INFRARED PRODUCTS

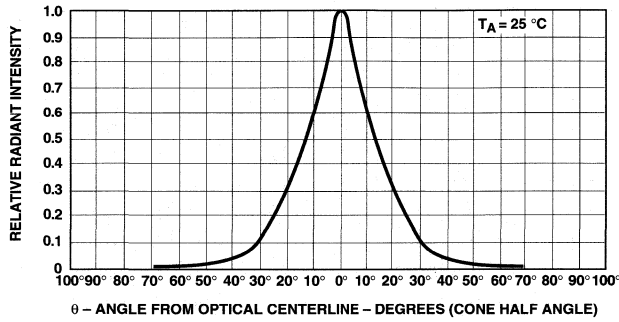

Figure 6. Relative Radiant Intensity vs. Angular Displacement HSDL-4220.

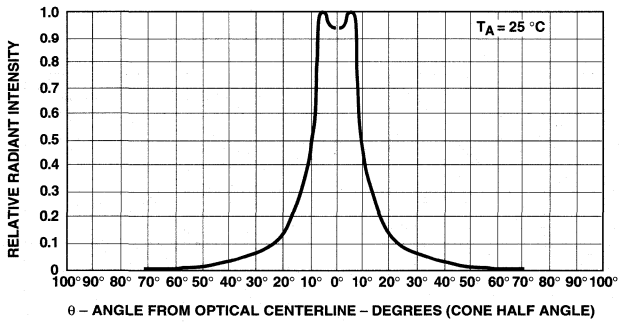

Figure 7. Relative Radiant Intensity vs. Angular Displacement HSDL-4230.

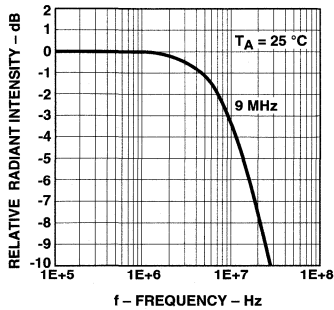

Figure 8. Relative Radiant Intensity vs. Frequency.

**Note:** At the time of this publication, Light Emitting Diodes (LEDs) that are contained in this product are regulated for eye safety in Europe by the Commission for European Electrotechnical Standardization (CENELEC) EN60825-1. Please refer to Application Briefs I-008, I-009, I-015 for more information.

# Infrared IrDA® Compliant Transceiver

## Preliminary Technical Data\*

### HSDL-1001

#### Features

- **Low Cost Infrared Data Link**
- **Guaranteed to Meet IrDA Physical Layer Specifications**
  - 1 cm – 1 M Operating Distance
  - 30° Viewing Angle
  - 2.4 Kbd – 115.2 Kbd Data Rate
- **Low Latency**
- **Shutdown Feature**
- **3 Volt Operation**
- **Very Low Static I<sub>CC</sub>**
- **Daylight Cancellation**
- **Direct Interface to I/O Chips and Glue Logic**

#### Applications

- **Serial Half-Duplex Data Transfer Between:**
  - Notebook Computers
  - Subnotebooks
  - Desktop PCs
  - PDA's
  - Printers
  - Other Peripheral Devices
- **Telecom**
  - Modem
  - Fax
  - Pager
  - Phones
- **Industrial**
  - Data Collection Devices
- **Medical**
  - Patient and Pharmaceutical Data Collection

#### Description

The HSDL-1001 serial infrared module is a low cost, low power solution to cableless IR communication. The link is a point-to-point, through the air serial, half duplex data transfer medium.

The module has been designed to the Infrared Data Association (IrDA) Physical Layer Specifications. It is designed to operate from 1 cm to 1 meter at a maximum data rate of 115.2 Kbd at a 30° viewing angle.

#### Schematic

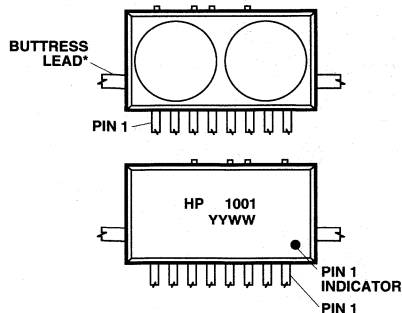

\* SIDE BUTTRESS LEADS ARE FOR MECHANICAL STABILITY AND SHOULD NOT BE CONNECTED TO ANY ELECTRICAL POTENTIAL.

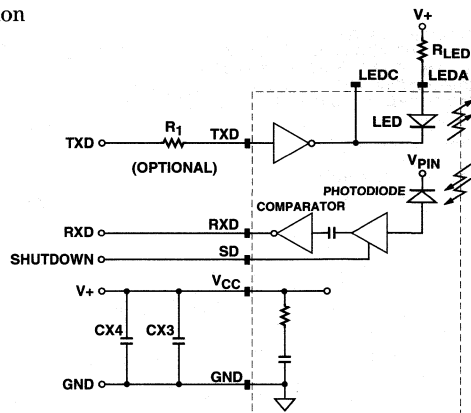

\*This data sheet represents the latest available information at the time of publication (10/1/95). For more current information, please consult with your HP Field Sales Office.

The HSDL-1001 contains a high speed, high efficiency TS AlGaAs 875 nm emitter, a PIN Silicon photodiode and an integrated

circuit. The IC contains an LED driver, amplifiers and a quantizer.

The shutdown feature allows

designers to turn off the receiver by pulsing the shutdown pin. The device draws less than 10  $\mu$ A when in shutdown mode.

### Package Dimensions

Option X01\*

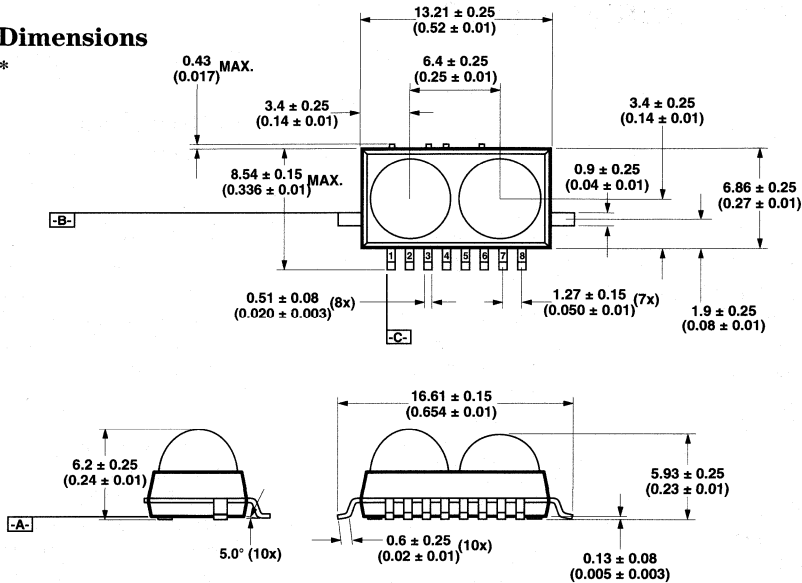

DIMENSIONS IN MILLIMETERS (INCHES).

Option X02\*

**NOTE:**  
THE -B- DATUM IS FORMED BY THE TWO HIGHEST POINTS OF THE COMBINED SURFACE FORMED BY THIS SURFACE AND THE CORRESPONDING SURFACE OF THE SAME LEAD ON THE OPPOSITE SIDE OF THE PACKAGE.

\*X POSITION INDICATES PACKAGING.  
0 = TAPE AND REEL.  
1 = JEDEC STANDARD ARRAY.

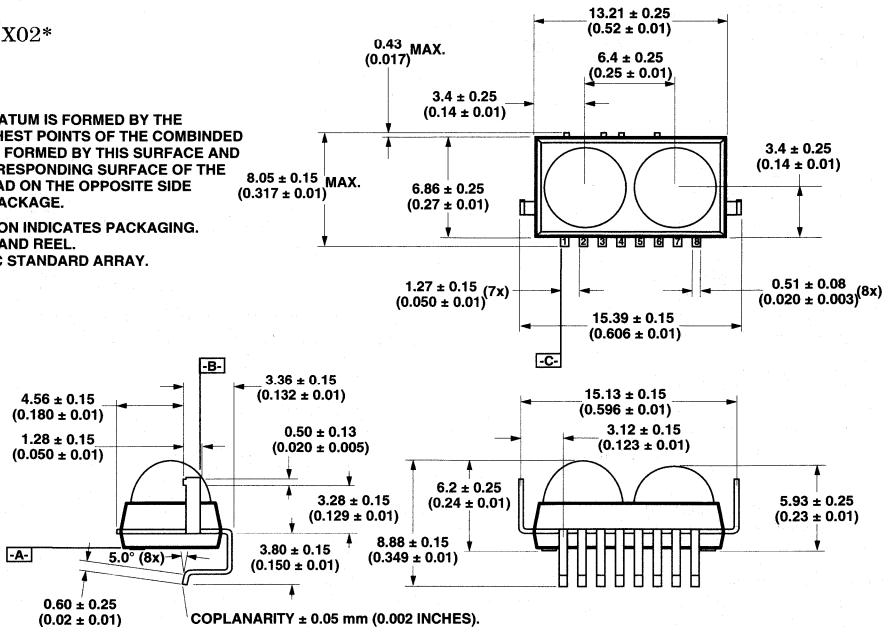

DIMENSIONS IN MILLIMETERS (INCHES).



# Package Dimensions (continued)

Option X03\*

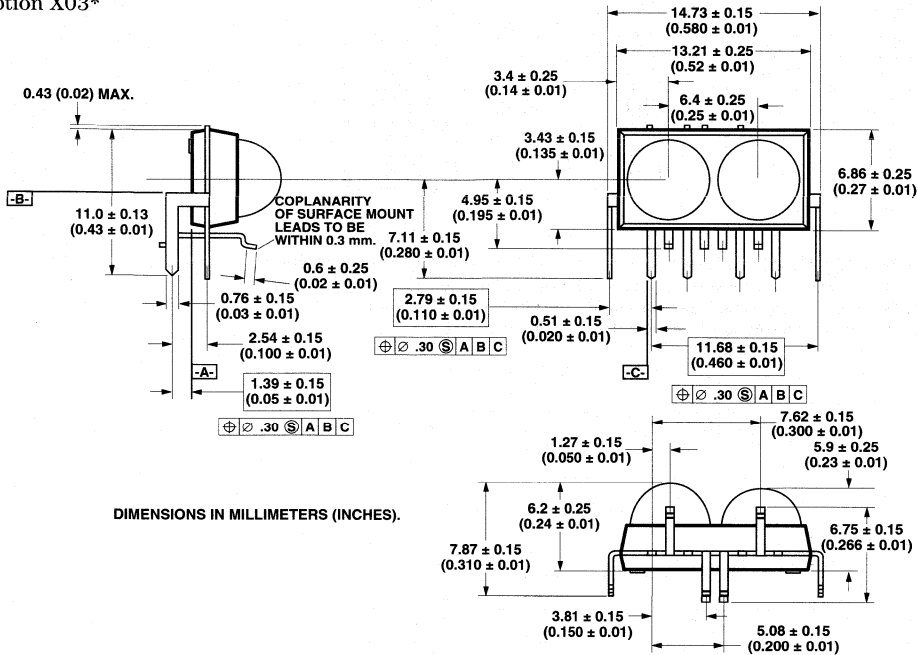

Option X04\*

NOTE:  
THE -B- DATUM IS FORMED BY THE TWO HIGHEST POINTS OF THE COMBINED SURFACE FORMED BY THIS SURFACE AND THE CORRESPONDING SURFACE OF THE SAME LEAD ON THE OPPOSITE SIDE OF THE PACKAGE.

\*X POSITION INDICATES PACKAGING.  
0 = TAPE AND REEL.  
1 = JEDEC STANDARD ARRAY.

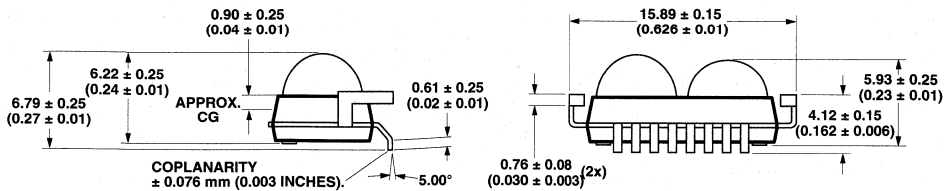
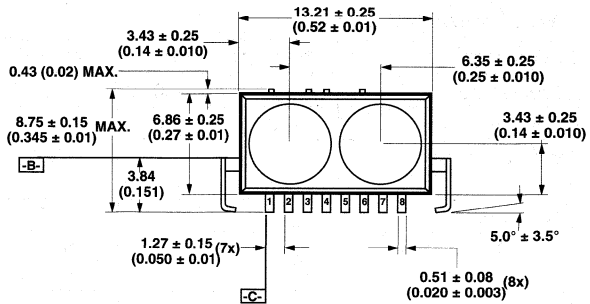

INFRARED PRODUCTS

## Truth Table

Inputs		LED	Shutdown	Outputs	
TXD	$E_I^{(1)}$		SD	LEDA	RXD
$V_{IH}$	X	ON	High	Low	Low <sup>(2)</sup>
$V_{IL}$	$E_{IH}$	OFF	High	High	Low <sup>(2)</sup>
$V_{IL}$	$E_{IL}$	OFF	High	High	High
X	X	OFF	Low	High	High

X = Don't care.

### Notes:

1.  $E_I$  – received in band light intensity present at detector surface.
2. Logic Low is a pulsed response. A receiver output low state  $V_{OL}$  (RXD) is not indefinitely maintained, but is instead a pulsed response. The output low state is maintained for a duration dependent on the incident bit pattern and the incident intensity ( $E_I$ ).

## Pinout

Pin	Description	Symbol
1	Shutdown	SD
2	Open	
3	Supply Voltage	$V_{CC}$
4	Receiver Data Output	RXD
5	Ground	Gnd
6	Transmitter Data Input	TXD
7	LED Cathode	LEDC
8	LED Anode	LEDA

## Absolute Maximum Ratings

Parameter	Symbol	Min.	Max.	Units	Conditions
Storage Temperature	$T_S$	-20	85	C	
Operating Temperature	$T_A$	0	55	C	
Lead Solder Temperature			260	C	For 10 s (1.6 mm below seating plane)
Average LED Current	$I_{LED}$ (DC)		100	mA	
Repetitive Pulsed LED Current	$I_{LED}$ (PK)		500	mA	$\leq 90 \mu\text{s}$ Pulse Width, $\leq 20\%$ Duty Cycle
Peak LED Current	$I_{LED}$ (RP)		1.0	A	$\leq 2 \mu\text{s}$ Pulse Width, $\leq 10\%$ Duty Cycle
LED Anode Voltage	$V_{LEDA}$	-0.5	7.0	V	
LED Cathode Voltage	$V_{LEDC}$	-0.5	$V_{LEDA}$	V	
Supply Voltage	$V_{CC}$	0	7.0	V	
Transmitter Data Input Voltage	$V_{TXD}$	-0.5	5.5	V	
Receiver Data Output Voltage	$V_{RXD}$	-0.5	$V_{CC} + 0.5$	V	

## Recommended Operating Conditions

Parameter	Symbol	Min.	Max.	Units	Conditions
Operating Temperature	$T_A$	0	70	°C	
Supply Voltage	$V_{CC}$	2.7	5.5	V	
Logic High Transmitter Input Voltage	$V_{IH}(TXD)$	2.5	5.5	V	
Logic Low Transmitter Input Voltage	$V_{IL}(TXD)$	0.0	0.3	V	
Logic High Receiver Input Irradiance (870 nm)	$E_{IH}$	0.0036	500	mW/cm <sup>2</sup>	For in-band signals*
Logic High Receiver Input Irradiance (950 nm)	$E_{IH}$	0.005		mW/cm <sup>2</sup>	For in-band signals*
Logic Low Receiver Input Irradiance	$E_{IL}$		0.3	μW/cm <sup>2</sup>	For in-band signals*
Transmitter Viewing Angle	$2\theta^{1/2}$	30		deg	
Receiver Viewing Angle	$2\phi^{1/2}$	30		deg	
LED (Logic High) Current Pulse Amplitude	$I_{LEDA}$	250		mA	For one metre links with daylight filters
Receiver Setup Time		100 μ	500	μsec	For full sensitivity after transmitting
Signal Rate RXD		2.4	116	Kbps	
Ambient Light					See IrDA Serial Infrared Physical Layer Link Specification, Appendix A for ambient levels. See Rx TH+ section at the end of this data sheet also.

\*Note: An in-band optical signal is a pulse/sequence where the peak wavelength,  $\lambda_p$ , is defined as  $850 \text{ nm} \leq \lambda_p \leq 900 \text{ nm}$ , the pulse repetition rate, PRR, is defined as  $2.4 \text{ Kp/s} \leq \text{PRR} \leq 115.2 \text{ Kp/s}$  and the pulse width, PW, is defined as  $1.6 \text{ s} \leq \text{PW} \leq (3/16)/\text{PRR}$ .

## Shutdown Parameters

Parameter	Symbol	Min.	Typ.	Max.	Units	Conditions
$I_{CC}$ Shutdown	$I_{CC \text{ SD}}$		8	20	μA	$V_{CC} = 5 \text{ Volts}$
$I_{CC}$ Shutdown	$I_{CC \text{ SD}}$		5	14	μA	$V_{CC} = 3 \text{ Volts}$
Shutdown Input Current			5	10	μA	$V_{CC} = 5 \text{ Volts}$
Shutdown Input Current			4	8	μA	$V_{CC} = 3 \text{ Volts}$
Wake Up Time			40	100	μs	

## Electrical & Optical Specifications

Specifications hold over the Recommended Operating Conditions unless otherwise noted. Test Conditions represent worse case values for the parameters under test. Unspecified test conditions can be anywhere in their operating range. All typicals are at 25°C and 5 V unless otherwise noted.

Parameter		Symbol	Min.	Typ.	Max.	Unit	Conditions
Receiver Data Output Voltage	Logic Low <sup>[2]</sup>	$V_{OL} (RXD)^{[2,3]}$			0.4	V	$I_O = 0.3 \text{ mA}$ , For In-Band $E_I \geq 3.6 \text{ } \mu\text{W}/\text{cm}^2$ , $\theta \leq 15^\circ$
	Logic High	$V_{OH} (RXD)$	$V_{CC} - 0.5$			V	$I_O = -20 \text{ } \mu\text{A}$ , For In-Band $E_I \leq 0.3 \text{ } \mu\text{W}/\text{cm}^2$
Effective Detector Area				0.2		$\text{cm}^2$	
Transmitter Radiant Intensity	Logic Low	$I_{EL}$			0.3	$\mu\text{W}/\text{SR}$	$V_I \leq 0.3 \text{ V}$
	Logic High Intensity	$I_{EH}$	44		250	$\text{mW}/\text{SR}$	$I_{LEDA} = 250 \text{ mA}$ , $V_I = 2.5 \text{ V}$ , $\theta \leq 30^\circ$
	Peak Wavelength	$\lambda_p$		875		nm	
	Spectral Line Half Width	$\Delta\lambda_{1/2}$		35		nm	
Transmitter	Viewing Angle	$\theta$	30		60	deg	
Receiver	Viewing Angle	$\phi$	30			deg	
Transmitter Data Input Current	Logic Low	$I_{IL}(\text{TXD})$	-1.0		1.0	$\mu\text{A}$	$\text{Gnd} \leq V_I \leq 0.3 \text{ V}$
	Logic High	$I_{IH}(\text{TXD})$		100	200	$\mu\text{A}$	$V_I = 2.5 \text{ V}$ , $R_I = 10 \text{ k}\Omega^{[4]}$
LED Anode On State Voltage	$V_{ON} (\text{LEDA})$				2.50	V	$I_{LEDA} = 250 \text{ mA}$ , $T_j = 25^\circ\text{C}$
LED Anode Off State Leakage	$I_{LK} (\text{LEDA})$				100	$\mu\text{A}$	$V_{LEDA} = V_{CC} = 5.5 \text{ V}$ , $V_I = 0.3 \text{ V}$
Supply Current TXD High	$I_{CC1}$				4.5	mA	$V_{CC} = 5.5 \text{ V}$ , $V_I (\text{TXD}) = V_{IH}$ , $I_{LED} = 250 \text{ mA}$ , $E_I = 0$
Supply Current RXD Low <sup>[2]</sup>	$I_{CC2}$				13.0	mA	$V_{CC} = 5.5 \text{ V}$ , $V_I (\text{TXD}) = V_{IL}$ , $E_I = 500 \text{ mW}/\text{cm}^2$
Supply Current (Enabled but Idle)	$I_{CC3}$			185		$\mu\text{A}$	$V_{CC} = 5.5 \text{ V}$ , $V_I (\text{TXD}) = V_{IL}$ , $E_I = 0$ , $I_{LED} = 0$
Receiver Peak Sensitivity Wavelength	$\lambda_p$			880		nm	

### Notes:

- $E_I$  – received in band light intensity present at detector surface.
- Pulsed Response – Logic Low is a pulsed response. A receiver output low state  $V_{OL}$  (RXD) is not indefinitely maintained but is instead a pulsed response. The output low state is maintained for a duration dependent on the incident bit pattern and incident intensity ( $E_I$ ).
- The  $E_I \geq 3.6 \text{ } \mu\text{W}/\text{cm}^2$  condition guarantees the IrDA minimum receiver sensitivity of  $4.0 \text{ } \mu\text{W}/\text{cm}^2$  while allowing for 10% light loss through a cosmetic window placed in front of the HSDL-1001.
- For  $I_{IH} (\text{TXD}) = 350 \text{ } \mu\text{A}$  maximum,  $V_{CC} = 5.0 \text{ volts}$ ,  $R_I = 0$ . If  $350 \text{ } \mu\text{A}$  can be accommodated,  $R_I$  can be removed.

## Switching Specifications

Specifications hold over the Recommended Operating Conditions unless otherwise noted. Test Conditions represent worst case values for the parameters under test. Unspecified test conditions can be anywhere in their operating range. All typicals are at 25°C and 5 V unless otherwise noted.

Parameter	Symbol	Min.	Typ.	Max.	Units	Conditions
Transmitter Turn On Time			0.1		μs	$I_{LED} = 250 \text{ mA}, 1.6 \text{ μs PW}$
Transmitter Turn Off Time			0.4	1.0	μs	
Transmitter Rise Time				0.6	μs	
Transmitter Fall Time				0.6		
Receiver Turn On Time			0.4		μs	$E_I = 3.6 \text{ μW/cm}^2, 1.6 \text{ μs PW}$
Receiver Turn Off Time				5.4	μs	$E_I = 500 \text{ mW/cm}^2, 1.6 \text{ μs PW}$
Receiver Rise Time			1.0		μs	$E_I = 3.6 \text{ μW/cm}^2, 1.6 \text{ μs PW}$
Receiver Fall Time			0.02			
Receiver Recovery Time			100		μs	

## Application Circuit

Component	Recommended Value
$R_1$	0 kΩ $V_{CC} = 5.0 \text{ volts}^*$
$R_{LED}$	8.0 Ω maximum
CX3	0.10 μF ± 22%. Low inductance is critical
CX4	4.7 μF minimum. Larger values recommended for noisy supplies or environments.

\*For  $V_{CC} = 3.0 \text{ volts}$ ,  $R_1 = 0$ .

## Appendix A. Test Methods

### A.1. Background Light and Electromagnetic Field

There are four ambient interference conditions in which the receiver is to operate correctly. The conditions are to be applied separately:

1. Electromagnetic field: 3 V/m maximum (refer to IEC 801-3, severity level 3 for details)
2. Sunlight: 10 kilolux maximum at the optical port  
This is simulated with an IR source having a peak wavelength within the range 850 nm to 900 nm and a spectral width less than 50 nm biased to provide 490  $\mu\text{W}/\text{cm}^2$  (with no modulation) at the optical port. The light source faces the optical port.

This simulates sunlight within the IrDA spectral range. The effect of longer wavelength radiation is covered by the incandescent condition.

3. Incandescent Lighting: 1000 lux maximum  
This is produced with general service, tungsten-filament, gas-filled, inside-frosted lamps in the 60 Watt to 150 Watt range to generate 1000 lux over the horizontal surface on which the equipment under test rests. The light sources are above the test area. The source is expected to have a filament temperature in the 2700 to 3050 degrees Kelvin range and a spectral peak in the 850 nm to 1050 nm range.
4. Fluorescent Lighting: 1000 lux maximum  
This is simulated with an IR

source having a peak wavelength within the range 850 nm to 900 nm and a spectral width of less than 50 nm biased and modulated to provide an optical square wave signal (0  $\mu\text{W}/\text{cm}^2$  minimum and 0.3  $\mu\text{W}/\text{cm}^2$  peak amplitude with 10% to 90% rise and fall times less than or equal to 100 ns) over the horizontal surface on which the equipment under test rests. The light sources are above the test area. The frequency of the optical signal is swept over the frequency range from 20 kHz to 200 kHz.

Due to the variety of fluorescent lamps and the range of IR emissions, this condition is not expected to cover all circumstances. It will provide a common floor for IrDA operation.

**Note:** At the time of this publication, Light Emitting Diodes (LEDs) that are contained in this product are regulated for eye safety in Europe by the Commission for European Electrotechnical Standardization (CENELEC) EN60825-1. Please refer to Application Briefs I-008, I-009, I-015 for more information.

# Infrared Transceiver

## Preliminary Technical Data

### HSDL-1100

#### Features

- **Fast Low Cost Infrared Data Link**
- **Backward Compatible to Slower Speeds**
- **Guaranteed to Meet IrDA Physical Layer Specifications**
  - 1 cm to 1 Meter Operating Distance
  - 30° Viewing Angle
  - 2 Channels –
    - 2.4 Kb/s to 115.2 Kb/s
    - 1.15 Mb/s – 4.0 Mb/s
- **ASK, HP-SIR and TV Remote Compatible**
- **Designed to Accommodate Light Loss with Cosmetic Windows**
- **No Mode Programming Required**

#### Applications

- **Data Communication: Serial Data Transfer Between:**
  - Notebook Computers
  - Subnotebook Computers
  - Desktop PCs
  - Printers
  - Other Peripheral Devices
- **Telecom Telephones**
- **IR LANs**

#### Block Diagram

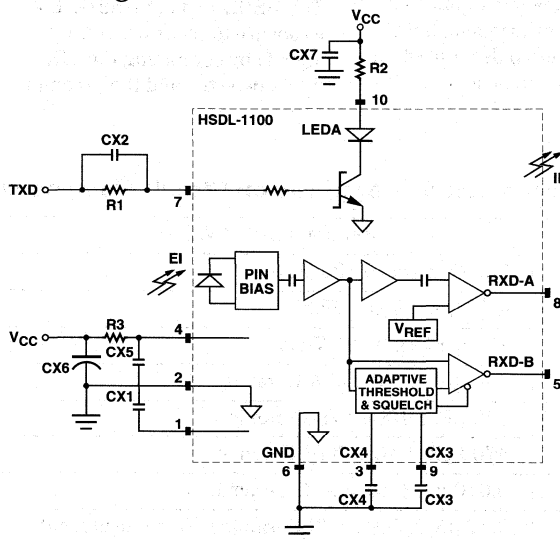

HSDL-1100 BLOCK DIAGRAM AND APPLICATION CIRCUIT

The HSDL-1100 infrared transceiver provides the interface between logic and IR signals for through-air, serial, half-duplex IR data links and is designed to satisfy the IrDA Physical Layer Specification.

The HSDL-1100 contains a high speed, high efficiency, TS AlGaAs, 870 nm LED, a silicon PIN photodiode and a bipolar, silicon integrated circuit. The IC contains an LED driver and a receiver providing two output

#### Preliminary Product Disclaimer

These products are under development. Until Hewlett-Packard releases these products for general sales, HP reserves the right at any time to alter prices, specifications, features, capabilities, functions, manufacturing release dates, and even general availability of the product. It is advisable to consult your local HP field sales engineer when considering these products for design-ins and production volumes.

signals, RXD-A for signal rates from 2.4 to 115.2 Kb/s and RXD-B for signal rates of 1.152 and 4.0 Mb/s.

The receiver is designed for maximum sensitivity to IrDA signals and minimum sensitivity to signals outside the IrDA optical wavelength and frequency modulation of interest. A receiver lens magnifies the effective area of the PIN diode to enhance sensitivity. The lens is integral with the molded package and contains a dye which adsorbs visible light. Receiver outputs pulse low when the IR signal is present.

To minimize the amplifier noise figure, bandwidth is constrained to that necessary for IrDA operation. Bias and compliance levels are selected to ensure a smooth change in response to signal power variation over a 54 dB dynamic range (54 dB between close high power signals and far away low power signals). Interfering electrical signals can be capacitively coupled into sensitive areas at the input of the preamp or injected via the power supply. The HSDL-1100 minimizes the exposure to these interfering signals by combining the PIN diode detector and the preampli-

fier within a hybrid module and integrating the preamplifier. The power supply for the PIN and preamplifier are filtered to attenuate noise conducted from external sources as well as noise generated by internal sources.

The transceiver is designed to interface directly with selected I/O chips that incorporate the modulation/demodulation function.

**Table 1. Recommended Application Circuit Components**

Component	Recommended Value
R1	560 $\Omega$ , $\pm$ 5%, 0.125 Watt
R2	4.7 $\Omega$ , $\pm$ 5%, 0.5 Watt
R3 <sup>[1]</sup>	10 $\Omega$ , $\pm$ 5%, 0.125 Watt
CX1 <sup>[2]</sup>	0.47 $\mu$ F, $\pm$ 10%, X7R Ceramic
CX2	220 pF, $\pm$ 10%, X7R Ceramic
CX3	4700 pF, $\pm$ 10%, X7R Ceramic
CX4	0.010 $\mu$ F, $\pm$ 10%, X7R Ceramic
CX5 <sup>[2]</sup>	0.47 $\mu$ F, $\pm$ 20%, X7R Ceramic $\leq$ 5 mm lead length
CX6	6.8 $\mu$ F Tantalum. Larger value recommended for noisy supplies or environments
CX7 <sup>[3]</sup>	0.47 $\mu$ F, $\pm$ 20%, X7R Ceramic

**Notes:**

1. In environments with noisy power supplies, supply rejection can be enhanced by including R3 as shown in application circuit on previous page.
2. CX1 and CX5 must be placed within 0.7 cm of the HSDL-1100 to obtain optimum noise immunity.
3. Only necessary in applications where transmitter switching causes more than a 50 mV ripple on  $V_{CC}$ .



## Truth Table

Inputs		Outputs		
TXD	E <sub>I</sub>	IE (LED)	RXD-A	RXD-B
V <sub>IH</sub>	X	High (On)	NV	NV
V <sub>IL</sub>	E <sub>IH</sub> <sup>[1]</sup>	Low (Off)	Low <sup>[3]</sup>	NV
V <sub>IL</sub>	E <sub>IH</sub> <sup>[2]</sup>	Low (Off)	NV	Low <sup>[3]</sup>
V <sub>IL</sub>	E <sub>IL</sub>	Low (Off)	High	High

X = Don't care

NV = Not Valid

### Notes:

1. In-Band EI ≤ 116 Kb/s
2. In-Band EI ≥ 1.15 Mb/s
3. Logic Low is a pulsed response. The condition is maintained for a duration dependent on pattern and strength of the incident intensity.

## Pinout

Pin	Description	Symbol
1	PIN Bypass Capacitor	CX1
2	Ground (Analog)	Gnd
3	Averaging Capacitor	CX4
4	Supply Voltage	V <sub>CC</sub>
5	Receiver Data Output – Channel B	RXD-B
6	Ground	Gnd
7	Transmitter Data Input	TXD
8	Receiver Data Output – Channel A	RXD-A
9	Threshold Capacitor	CX3
10	LED Anode	LEDA

# Package Dimensions

HSDL-1100  
Option X07

THE -B- DATUM IS FORMED BY THE HIGHEST POINT ON THE SURFACE AND THE HIGHEST POINT ON THE CORRESPONDING SURFACE OF THE LEAD ON THE OTHER SIDE OF THE PACKAGE.

DIMENSIONS IN MILLIMETERS (INCHES).

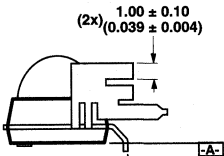
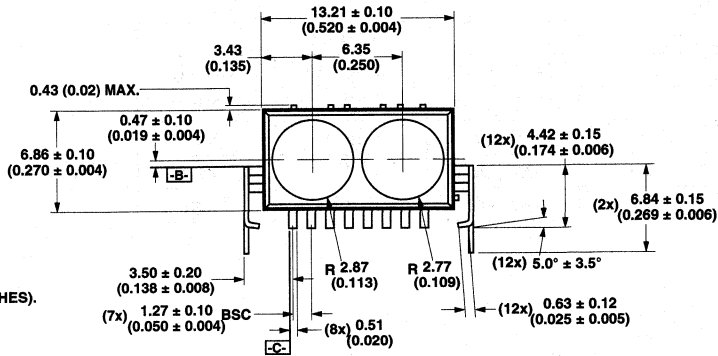

COPLANARITY OF LEADS TO BE 0.1 mm (0.076 mm TOOL)

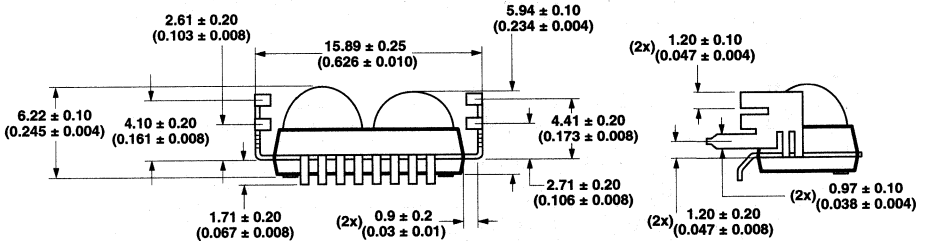

HSDL-1100  
Option X08

THE -B- DATUM IS FORMED BY THE TWO HIGHEST POINTS OF THE COMBINED SURFACE FORMED BY THIS SURFACE AND THE CORRESPONDING SURFACE OF THE SAME LEAD ON THE OPPOSITE SIDE OF THE PACKAGE.

DIMENSIONS IN MILLIMETERS (INCHES).

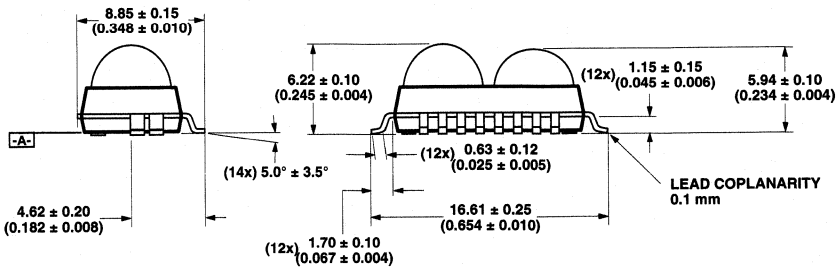
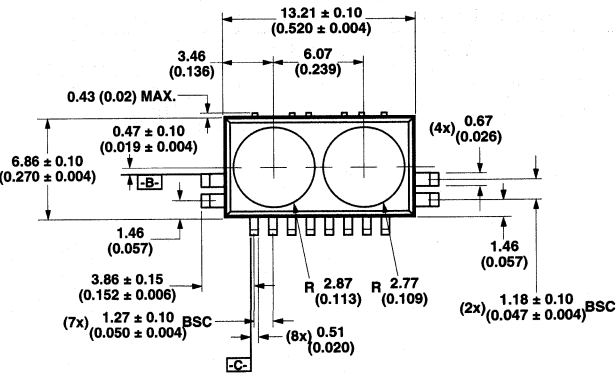

## Absolute Maximum Ratings<sup>[1]</sup>

Parameter	Symbol	Min.	Max.	Units	Conditions
Storage Temperature	T <sub>S</sub>	-20	85	°C	
Operating Temperature	T <sub>A</sub>	0	70	°C	
Lead Solder Temperature			260	°C	For 10 s (1.6 mm below seating plane)
Average LED Current	I <sub>LED</sub> (DC1)		100	mA	
Average LED Current	I <sub>LED</sub> (DC2)		165	mA	≤ 90 μs Pulse Width, ≤ 25% Duty Cycle
Repetitive Pulsed LED Current	I <sub>LED</sub> (RP)		660	mA	≤ 90 μs Pulse Width, ≤ 25% Duty Cycle
Peak LED Current	I <sub>LED</sub> (PK)		1.0	A	≤ 2 μs Pulse Width, ≤ 10% Duty Cycle
LED Anode Voltage	V <sub>LEDA</sub>	-0.5	7.0	V	
Supply Voltage	V <sub>CC</sub>	0	7.0	V	
Transmitter Data Input Voltage	I <sub>TXD</sub> (DC)	-12	12	mA	
Receiver Data Output Voltage	V <sub>RXD-A</sub> V <sub>RXD-B</sub>	-0.5 -0.5	V <sub>CC</sub> + 0.5 V <sub>CC</sub> + 0.5	V V	

### Note:

- For implementations where case to ambient thermal resistance ≤ 50°C/W.

## Recommended Operating Conditions

Parameter	Symbol	Min.	Max.	Units	Conditions
Operating Temperature	T <sub>A</sub>	0	70	°C	
Supply Voltage	V <sub>CC</sub>	4.75	5.25	V	
Logic High Transmitter Input Voltage	V <sub>IH</sub> (TXD)	4.25	5.25	V	[2]
Logic Low Transmitter Input Voltage	V <sub>IL</sub> (TXD)	0.0	0.3	V	[2]
Logic High Receiver Input Irradiance	E <sub>IH</sub>	0.0036 0.0090	500 500	mW/cm <sup>2</sup>	For in-band signals ≤ 116 Kb/s <sup>[1]</sup> For in-band signals ≤ 1.15 M
Logic Low Receiver Input Irradiance	E <sub>IL</sub>		0.3	μW/cm <sup>2</sup>	For in-band signals <sup>[1]</sup>
LED (Logic High) Current Pulse Amplitude	I <sub>LEDA</sub>	450	660	mA	For one metre links with daylight filters
Receiver Setup Time		1.0		ms	For full sensitivity after transmitting
Receiver Signal Rate RXD-A		2.4	116	Kb/s	
Receiver Signal Rate RXD-B		1	4	Mb/s	
Ambient Light					See IrDA Serial Infrared Physical Layer Link Specification, Appendix A for ambient levels.

### Notes:

- An in-band optical signal is a pulse/sequence where the peak wavelength, λ<sub>p</sub>, is defined as 850 nm ≤ λ<sub>p</sub> ≤ 900 nm, and the pulse characteristics are compliant with the IrDA Serial Infrared Physical Layer Link Specification.
- With RI, CX1 Input network and where t<sub>r</sub> (V<sub>I</sub>) and t<sub>f</sub> (V<sub>I</sub>) ≤ 5 ns. See Application Circuit (Table 1) for component values. The driver gate for this input should be able to source and sink ± 6 mA (DC) and ± 50 mA (pk). TXD refers to the node on the driver gate side of R1, CX2 on application circuit.

## Electrical and Optical Specifications

Specifications hold over the Recommended Operating Conditions unless otherwise noted. Test Conditions represent worse case values for the parameters under test. Unspecified test conditions can be anywhere in their operating range. All typicals are at 25°C and 5 V unless otherwise noted.

Parameter	Symbol	Min.	Typ.	Max.	Unit	Conditions	
Receiver Data Output Voltage	Logic Low <sup>[2]</sup>	$V_{OL}$ (RXD-A) <sup>[2]</sup>			0.5	V	$I_O = 1.0 \text{ mA}$ , For in-band $E_I \geq 3.6 \text{ } \mu\text{W}/\text{cm}^2$
	Logic Low <sup>[2]</sup>	$V_{OL}$ (RXD-B) <sup>[2]</sup>			0.5	V	$I_O = 1.0 \text{ mA}$ , For in-band $E_I \geq 9.0 \text{ } \mu\text{W}/\text{cm}^2$
	Logic High	$V_{OH}$ (RXD-A)	$V_{CC}-0.5$			V	$I_O = -20 \text{ } \mu\text{A}$ , For in-band $E_I \leq 0.3 \text{ } \mu\text{W}/\text{cm}^2$
	Logic High	$V_{OH}$ (RXD-B)	$V_{CC}-1.0$			V	$I_O = -20 \text{ } \mu\text{A}$ , For in-band $E_I \leq 0.3 \text{ } \mu\text{W}/\text{cm}^2$
	Viewing Angle	$2\phi 1/2$	30			degree	
Effective Detector Area			0.2			$\text{cm}^2$	
Transmitter Radiant Intensity	Logic Low	$I_{EL}$			0.3	$\mu\text{W}/\text{SR}$	$V_I \leq 0.3 \text{ V}$
	Logic High Intensity	$I_{EH}$ <sup>[3]</sup>	100	180	400	$\text{mW}/\text{SR}$	$V_I = 2.5 \text{ V}$ , $I_{LEDA} = 450 \text{ mA}$ $T_A = 25^\circ\text{C}$
	Peak Wavelength	$\lambda_p$		875		nm	
	Spectral Line Half Width	$\Delta\lambda 1/2$		35		nm	
	Viewing Angle	$2\theta 1/2$	30			degree	
Transmitter Data Input Current	Logic Low	$I_{IL}(\text{TXD})$	-1.0		1.0	$\mu\text{A}$	$\text{Gnd} \leq V_I \leq 0.3 \text{ V}$
	Logic High	$I_{IH}(\text{TXD})$	5.4		6.6	mA	$V_I = 4.25 \text{ V}^{[1]}$
LED Anode On State Voltage	$V_{ON}(\text{LEDA})$			2.54	V	$I_{LEDA} = 450 \text{ mA}$ , $25^\circ\text{C}$ $V_I = 4.25 \text{ V}^{[1]}$	
LED Anode Off State Leakage	$I_{LK}(\text{LEDA})$			100	$\mu\text{A}$	$V_{LEDA} = V_{CC} = 5.25 \text{ V}$ , $V_I = 0.3 \text{ V}^{[1]}$	
Supply Current	$I_{CC1}$		3	4.5	mA	$V_{CC} = 5.25 \text{ V}$ , $V_I(\text{TXD}) = V_{IL}$ , $E_I = 0$	
Receiver Peak Sensitivity Wavelength	$\lambda_p$		880		nm		

### Notes:

1. With R1, CX2 input network. See Application Circuit (Table 1) for component values. TXD refers to driver gate of R1, CX2 on application circuit.
2. Logic Low is a pulsed response. The condition is maintained for a duration dependent on pattern and strength of the incident intensity.
3. Min and Typ include a 20% lifetime allowance for degradation in light output of LED. Transmitter intensity decreases with temperature by 0.6% per degree C.

## Switching Specifications

Specifications hold over the Recommended Operating Conditions unless otherwise noted. Test Conditions represent worst case values for the parameters under test. Unspecified test conditions can be anywhere in their operating range. All typicals are at 25°C and 5 V unless otherwise noted.

Parameter	Symbol	Min.	Typ.	Max.	Unit	Conditions
Transmitter Radiant Intensity Pulse Width		1.5	1.6	1.8	μs	1.6 μs PW, 115.2 Kb/s PRR
		115	125	135	ns	125 ns PW, 4 Mb/s PRR
Transmitter Radiant Intensity Rise and Fall Times	$t_r(IE)$ , $t_f(IE)$			40	ns	125 ns PW, 4 Mb/s, PPM
RXD-A Pulse Width		1.0		7.5	μs	[1]
RXD-B Pulse Width		85		165	ns	[2]
Receiver Recovery Time			0.50	1.0	ms	

### Notes:

- For In-Band signals  $\leq 115.2$  Kb/s where  $3.6 \mu\text{W}/\text{cm}^2 \leq E_{\text{IL}} \leq 500 \text{ mW}/\text{cm}^2$ .
- For In-Band signals, 125 ns PW, 4 Mb/s, 4 PPM where  $9.0 \mu\text{W}/\text{cm}^2 \leq E_{\text{I}} \leq 500 \text{ mW}/\text{cm}^2$ .

## Appendix A. Test Methods

### A.1. Background Light and Electromagnetic Field

There are four ambient interference conditions in which the receiver is to operate correctly. The conditions are to be applied separately:

1. Electromagnetic field: 3 V/m maximum (refer to IEC 801-3. severity level 3 for details)
2. Sunlight: 10 kilolux maximum at the optical port  
This is simulated with an IR source having a peak wavelength within the range 850 nm to 900 nm and a spectral width less than 50 nm biased to provide  $490 \mu\text{W}/\text{cm}^2$  (with no modulation) at the optical port. The light source faces the optical port.

- This simulates sunlight within the IrDA spectral range. The effect of longer wavelength radiation is covered by the incandescent condition.
3. Incandescent Lighting: 1000 lux maximum  
This is produced with general service, tungsten-filament, gas-filled, inside-frosted lamps in the 60 Watt to 150 Watt range to generate 1000 lux over the horizontal surface on which the equipment under test rests. The light sources are above the test area. The source is expected to have a filament temperature in the 2700 to 3050 degrees Kelvin range and a spectral peak in the 850 nm to 1050 nm range.
  4. Fluorescent Lighting: 1000 lux maximum  
This is simulated with an IR source having a peak wave-

length within the range 850 nm to 900 nm and a spectral width of less than 50 nm biased and modulated to provide an optical square wave signal ( $0 \mu\text{W}/\text{cm}^2$  minimum and  $0.3 \mu\text{W}/\text{cm}^2$  peak amplitude with 10% to 90% rise and fall times less than or equal to 100 ns) over the horizontal surface on which the equipment under test rests. The light sources are above the test area. The frequency of the optical signal is swept over the frequency range from 20 kHz to 200 kHz.

Due to the variety of fluorescent lamps and the range of IR emissions, this condition is not expected to cover all circumstances. It will provide a common floor for IrDA operation.

**Note:** At the time of this publication, Light Emitting Diodes (LEDs) that are contained in this product are regulated for eye safety in Europe by the Commission for European Electrotechnical Standardization (CENELEC) EN60825-1. Please refer to Application Briefs I-008, I-009, I-015 for more information.

---

# High-Performance IR Emitter and IR PIN Photodiode in Subminiature SMT Package

## Technical Data

---

### HSDL-44XX IR Emitter Series HSDL-54XX IR Detector Series

---

#### Features

- **Subminiature Flat Top and Dome Package**  
Size – 2x2 mm
- **IR Emitter**  
875 nm TS AlGaAs  
Intensity – 17 mW/sr  
Speed – 40 ns
- **Wide Range of Drive Currents**  
500  $\mu$ A to 500 mA
- **IR Detector**  
PIN Photodiode  
High Sensitivity  
Speed – 7.5 ns
- **Flexible Lead Configurations**  
Surface Mount or  
Through Hole

---

#### Applications

- **Short Distance IR Links**
- **IrDA Compatible**
- **Small Handheld Devices**  
Pagers  
Industrial Handhelds
- **Diffuse LANs**
- **Wireless Audio**

#### Description

##### Flat Top Package

The HSDL-4400 Series of flat top IR emitters use an untinted, nondiffused, truncated lens to provide a wide radiation pattern that is useful for short distance communication where alignment of the emitter and detector is not critical. The HSDL-5400 Series of flat top IR detectors uses the same truncated lens design as the HSDL-4400 Series of IR emitters with the added feature of a black tint that acts as an optical filter to reduce the effects of ambient light, such as sun, incandescent and fluorescent light from interfering with the IR signal.

##### Dome Package

The HSDL-4420 Series of dome IR emitters uses an untinted, nondiffused lens to provide a 24 degree viewing angle with high on-axis intensity. The HSDL-5420 Series of IR detectors uses the same lens design as the HSDL-4420 IR emitter and optical filter used in the HSDL-5400 IR detector.

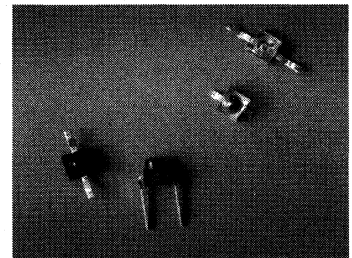

#### Lead Configuration

All of these devices are made by encapsulating LED and PIN photodiode chips on axial lead frames to form molded epoxy subminiature packages. A variety of lead configurations is available and includes: surface mount gull wing, yoke lead, or Z-bend and through hole lead bends at 2.54 mm (0.100 inch) center spacing.

#### Technology

The subminiature solid state emitters utilize a highly optimized LED material, transparent substrate aluminum gallium arsenide, TS AlGaAs. This material has a very high radiant efficiency, capable of producing high light output over a wide range of drive currents and temperature.

## Device Selection Guide

### IR Emitters

Part Number	Device Description <sup>[1]</sup>	Device Outline Drawing
HSDL-4400	LED, Flat Top, 110 deg	A
HSDL-4420	LED, Dome, 24 deg	B

### IR Detectors

Part Number	Device Description <sup>[1]</sup>	Device Outline Drawing
HSDL-5400	PIN Photodiode, Flat Top, 110 deg	C
HSDL-5420	PIN Photodiode, Dome, 28 deg	D

### Package Configuration Options

Option Code	Package Configuration Description		Package Outline Drawing
011	Gull Wing Lead, Tape and Reel <sup>[2]</sup>		E, J, M
021	Yoke Lead, Tape and Reel <sup>[2]</sup>		F, K, M
031	Z-Bend, Tape and Reel <sup>[2]</sup>		
1L1	2.54 mm (0.100 in) Center Lead Spacing	Long Leads; 10.4 mm (0.410 in)	Thru Hole Lead
1S1		Short Leads; 3.7 mm (0.145 in)	
No Option	Straight Leads <sup>[3]</sup>		Prototyping

#### Notes:

1. IR Emitters have untinted, nondiffused lenses and IR Detectors have black tinted, nondiffused lenses.
2. Emitters and detectors are supplied in 12 mm embossed tape on 178 mm (7 inch) diameter reels, with 1500 units per reel. Minimum order quantity and order increment are in quantity of reels only.
3. Emitters and detectors are supplied in bulk form in bags of 50 units.

## Package Dimensions

### (A) Flat Top Emitters

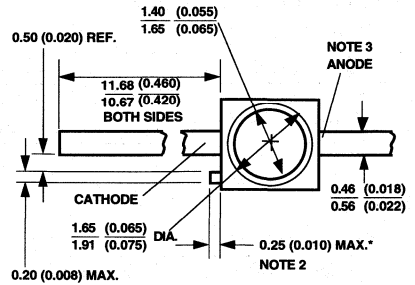
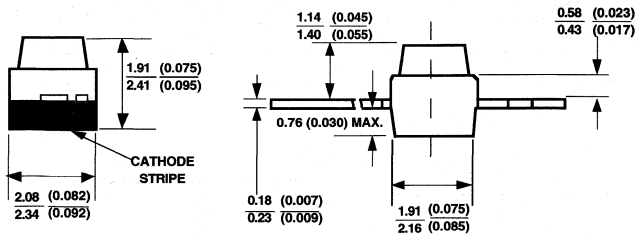

### (B) Dome Emitters

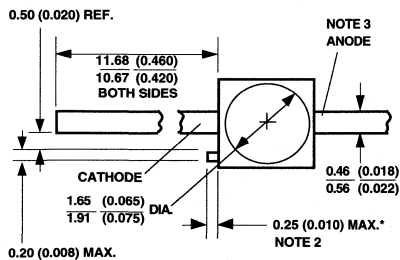
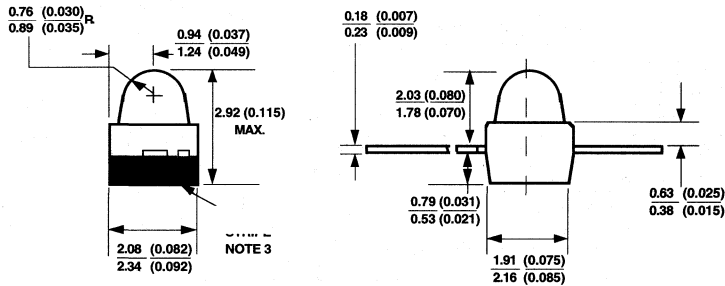

#### NOTES:

1. ALL DIMENSIONS ARE IN MILLIMETRES (INCHES).
2. PROTRUDING SUPPORT TAB IS CONNECTED TO ANODE LEAD.
3. LEAD POLARITY FOR THESE TS AlGaAs SUBMINIATURE LAMPS IS OPPOSITE TO THE LEAD POLARITY OF SUBMINIATURE LAMPS USING OTHER LED TECHNOLOGIES. CATHODE STRIPE MARKING IS BLACK.



**(C) Flat Top Detectors**

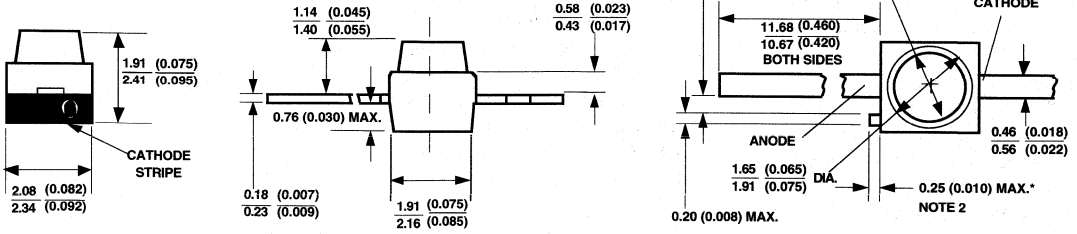

**(D) Dome Detectors**

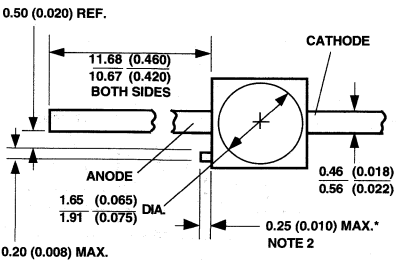
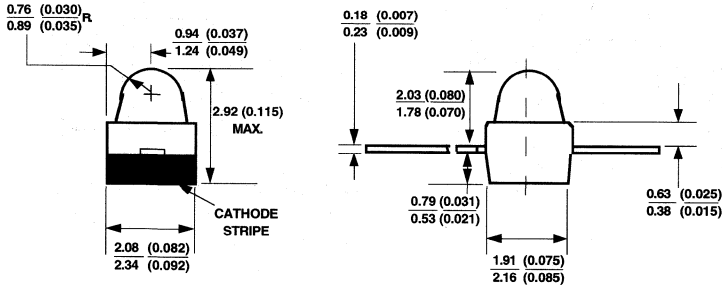

- NOTES:**
1. ALL DIMENSIONS ARE IN MILLIMETERS (INCHES).
  2. PROTRUDING SUPPORT TAB IS CONNECTED TO CATHODE LEAD.
  3. CATHODE STRIPE MARKING IS SILVER.

INFRARED PRODUCTS

### Package Dimensions

The following notes affect the package outline drawings E through I.

1. The pinout represents the HSDL-54XX IR detectors where the protruding support tab is closest to the anode lead. While the pinout is reversed for the HSDL-44XX

IR emitters where the protruding support tab is closest to the cathode lead.

2. The protruding support tab of the HSDL-54XX is connected to the cathode lead. While the protruding support tab of the HSDL-44XX is connected to the anode lead.

### (E) Gull Wing Lead, Option 011

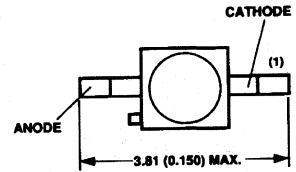
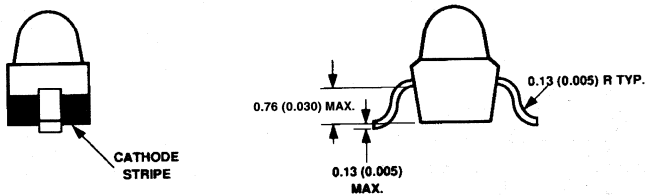

ALL DIMENSIONS ARE IN MILLIMETRES (INCHES)

### (F) "Yoke" Lead, Options 021

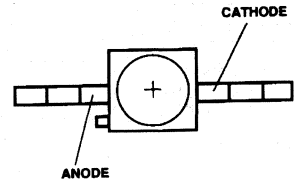
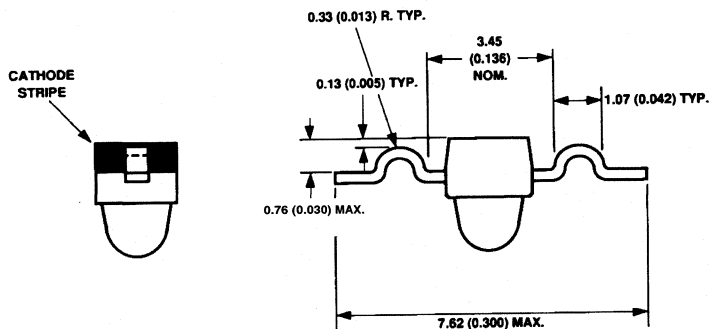

(0.013) R TYP.

ALL DIMENSIONS ARE IN MILLIMETRES (INCHES)

**(G) Z-Bend Lead, Options 031**

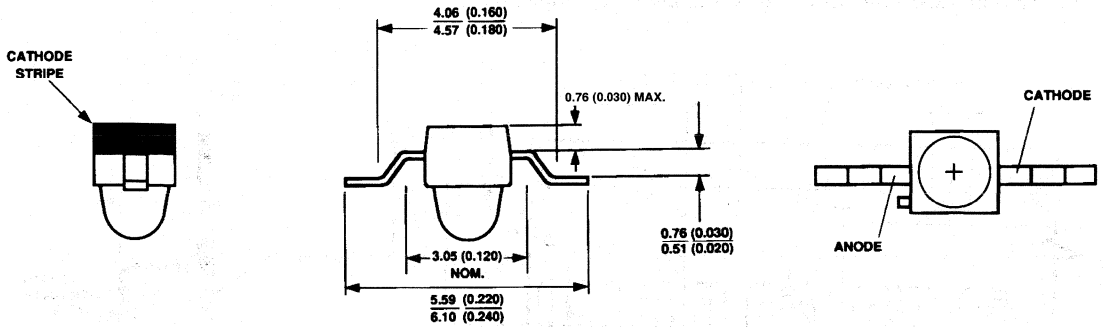

ALL DIMENSIONS ARE IN MILLIMETRES (INCHES)

**(H) Thru Hole Lead Option 1L1**

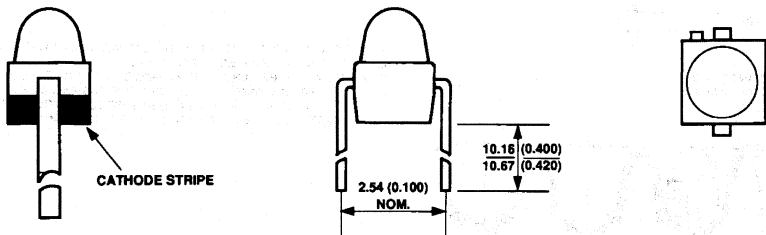

ALL DIMENSIONS ARE IN MILLIMETRES (INCHES)

**(I) Thru Hole Lead Option 1S1**

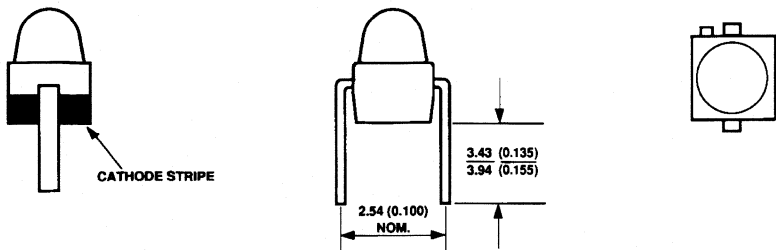

ALL DIMENSIONS ARE IN MILLIMETRES (INCHES)

INFRARED PRODUCTS

**Package Dimensions: Surface Mount Tape and Reel Options**  
**(J) 12 mm Tape and Reel, Gull Wing Lead, Option 011**

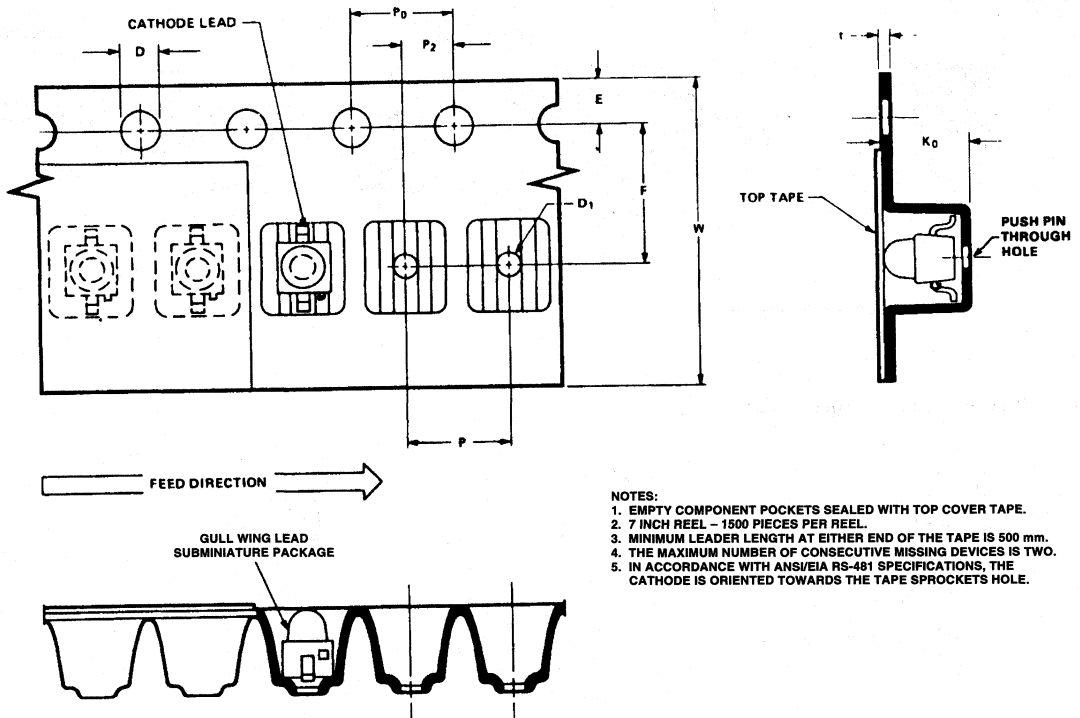

- NOTES:
1. EMPTY COMPONENT POCKETS SEALED WITH TOP COVER TAPE.
  2. 7 INCH REEL - 1500 PIECES PER REEL.
  3. MINIMUM LEADER LENGTH AT EITHER END OF THE TAPE IS 500 mm.
  4. THE MAXIMUM NUMBER OF CONSECUTIVE MISSING DEVICES IS TWO.
  5. IN ACCORDANCE WITH ANSI/EIA RS-481 SPECIFICATIONS, THE CATHODE IS ORIENTED TOWARDS THE TAPE SPROCKETS HOLE.

At the time of this publication XX/96, Light Emitting Diodes (LEDs) that are contained in this product are regulated for eye safety in Europe by the Commission for European Electrotechnical Standardization (CENELEC) EN60825-1. Please refer to Application Brief I-008 for more information.

**(K) 12 mm Tape and Reel, "Yoke" Lead, Option 021**

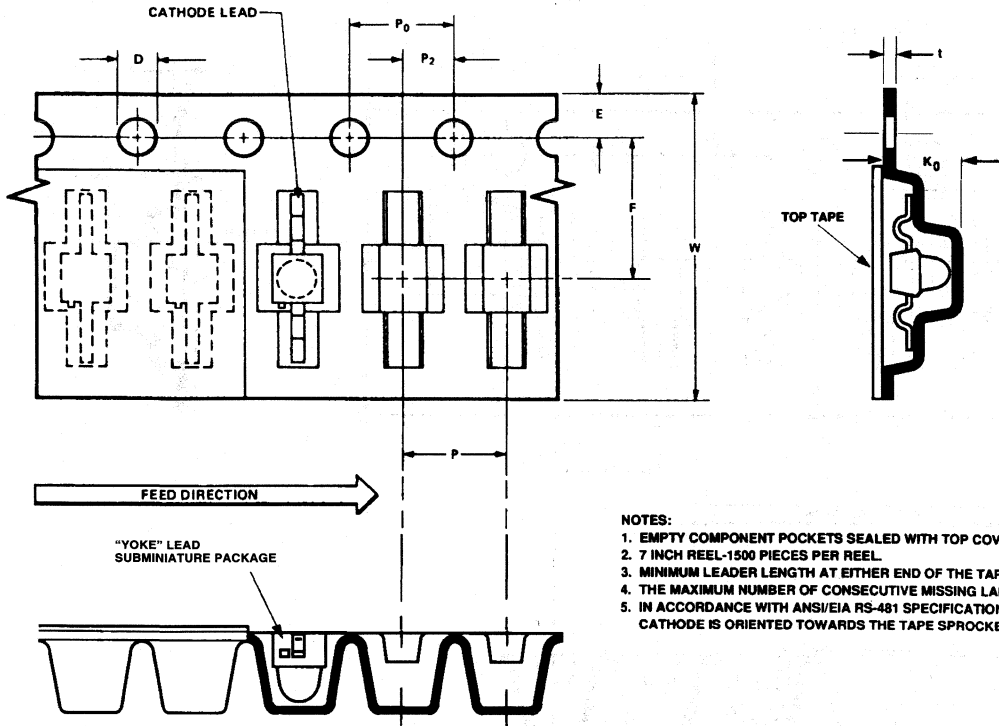

**NOTES:**

1. EMPTY COMPONENT POCKETS SEALED WITH TOP COVER TAPE.
2. 7 INCH REEL-1500 PIECES PER REEL.
3. MINIMUM LEADER LENGTH AT EITHER END OF THE TAPE IS 500 mm.
4. THE MAXIMUM NUMBER OF CONSECUTIVE MISSING LAMPS IS TWO.
5. IN ACCORDANCE WITH ANSI/EIA RS-481 SPECIFICATIONS, THE CATHODE IS ORIENTED TOWARDS THE TAPE SPROCKET HOLE.

(L) 12 mm Tape and Reel, Z-Bend Lead, Option 031

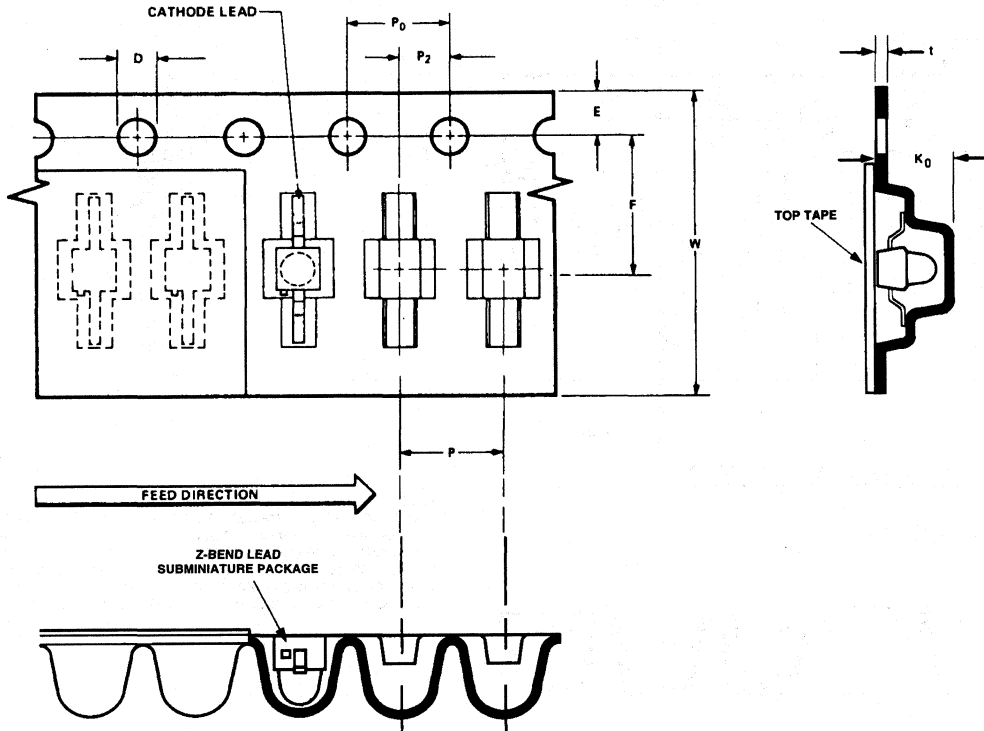

**(M) 12 mm Tape and Reel**

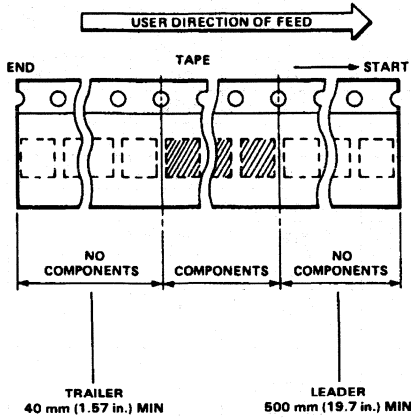

TOLERANCES (UNLESS OTHERWISE SPECIFIED):  
 .X ± .1; .XX ± .05 (.XXX ± .004)

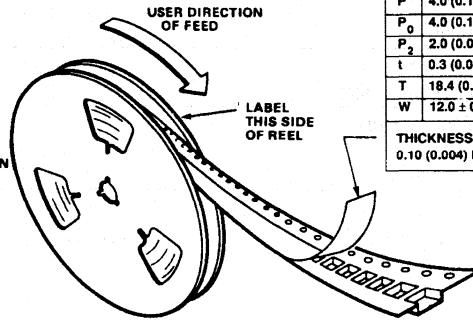

DIMENSIONS PER ANS/EIA STANDARD RS-481. ALL DIMENSIONS ARE IN MILLIMETRES (INCHES).	
A	178.0 ± 2.0 (7.0 ± 0.08) DIA.
C	13.0 (0.512) DIA. TYP.
D	1.55 (0.061 ± 0.002) DIA.
D <sub>1</sub>	1.0 (0.039) DIA. MIN.
D <sub>2</sub>	20.2 (0.795) DIA. MIN.
E	1.75 ± 0.1 (0.069)
F	5.50 (0.127 ± 0.002)
K <sub>0</sub>	3.05 ± 0.1 (0.120) TYP.
N	50.0 (1.970) MIN.
P	4.0 (0.157) TYP.
P <sub>0</sub>	4.0 (0.157) TYP.
P <sub>2</sub>	2.0 (0.079 ± 0.002) TYP.
t	0.3 (0.012) TYP.
T	18.4 (0.72) MAX.
W	12.0 ± 0.3 (0.472 ± 0.012)
THICKNESS OF TOP COVER TAPE 0.10 (0.004) MAX.	

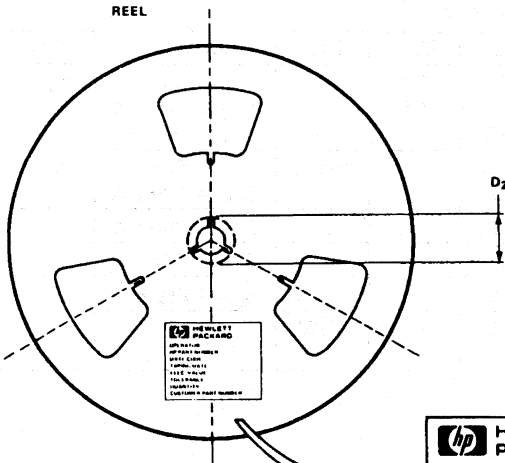

	<b>HEWLETT PACKARD</b>
OPERATOR	_____
HP PART NUMBER	_____
DATE CODE	_____
TAPING DATE	_____
ELEC. VALUE	_____
TOLERANCE	_____
QUANTITY	_____
CUSTOMER PART NUMBER	_____

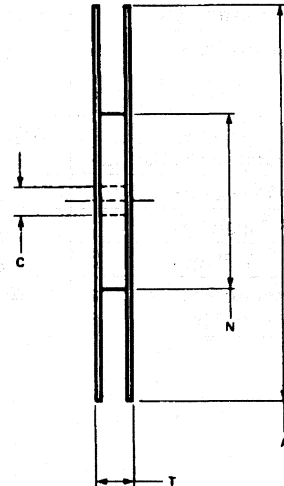

INFRARED PRODUCTS

### HSDL-44XX Absolute Maximum Ratings

Parameter	Symbol	Min.	Max.	Unit	Ref.
Peak Forward Current (Duty Factor = 20%, Pulse Width = 100 $\mu$ s)	$I_{FPK}$		500	mA	Fig. 7, 8
DC Forward Current	$I_{FDC}$		100	mA	Fig. 6
Power Dissipation	$P_{DISS}$		180	mW	
Reverse Voltage ( $I_R = 100 \mu$ A)	$V_R$	5		V	
Transient Forward Current (10 $\mu$ s Pulse)	$I_{FTR}$		1.0	A	[1]
Operating Temperature	$T_O$	-40	85	$^{\circ}$ C	
Storage Temperature	$T_S$	-55	100	$^{\circ}$ C	
Junction Temperature	$T_J$		110	$^{\circ}$ C	
Lead Solder Temperature [1.6 mm (0.063 in.) from body]			260/5 s	$^{\circ}$ C	
Reflow Soldering Temperatures Convection IR Vapor Phase			235/90 s 215/180 s	$^{\circ}$ C $^{\circ}$ C	

**Notes:**

- The transient peak current in the maximum nonrecurring peak current the device can withstand without damaging the LED die and the wire bonds.

### HSDL-44XX Electrical Characteristics at $T_A = 25^{\circ}$ C

Parameter	Symbol	Min.	Typ.	Max.	Unit	Condition	Ref.
Forward Voltage	$V_F$	1.30 1.40	1.50 1.67 2.15	1.70 1.85	V	$I_{FDC} = 50$ mA $I_{FDC} = 100$ mA $I_{FPK} = 250$ mA	Fig. 2
Forward Voltage Temperature Coefficient	$\Delta V_F/\Delta T$		-2.1 -2.1		mV/ $^{\circ}$ C	$I_{FDC} = 50$ mA $I_{FDC} = 100$ mA	Fig. 3
Series Resistance	$R_S$		2.8		$\Omega$	$I_{FDC} = 100$ mA	
Diode Capacitance	$C_O$		40		pF	0 V, 1 MHz	
Reverse Voltage	$V_R$	5	20		V	$I_R = 100 \mu$ A	
Thermal Resistance, Junction to Pin	$R\theta_{jp}$		170		$^{\circ}$ C/W		



### HSDL-44XX Optical Characteristics at $T_A = 25^\circ\text{C}$

Parameter	Symbol	Min.	Typ.	Max.	Unit	Condition	Ref.
Radiant Optical Power							
HSDL-4400	$P_O$		16 30		mW	$I_{FDC} = 50\text{ mA}$ $I_{FDC} = 100\text{ mA}$	
HSDL-4420	$P_O$		16 30		mW	$I_{FDC} = 50\text{ mA}$ $I_{FDC} = 100\text{ mA}$	
Radiant On-Axis Intensity							
HSDL-4400	$I_E$	1	3 6 15	8	mW/sr	$I_{FDC} = 50\text{ mA}$ $I_{FDC} = 100\text{ mA}$ $I_{FPK} = 250\text{ mA}$	Fig. 4, 5
HSDL-4420	$I_E$	9	17 32 85	30	mW/sr	$I_{FDC} = 50\text{ mA}$ $I_{FDC} = 100\text{ mA}$ $I_{FPK} = 250\text{ mA}$	Fig. 4, 5
Radiant On-Axis Intensity Temperature Coefficient	$\Delta I_E/\Delta T$		-0.35 -0.35		%/ $^\circ\text{C}$	$I_{FDC} = 50\text{ mA}$ $I_{FDC} = 100\text{ mA}$	
Viewing Angle							
HSDL-4400	$2\theta_{1/2}$		110		deg	$I_{FDC} = 50\text{ mA}$	Fig. 9
HSDL-4420	$2\theta_{1/2}$		24		deg	$I_{FDC} = 50\text{ mA}$	Fig. 10
Peak Wavelength	$\lambda_{PK}$	860	875	895	nm	$I_{FDC} = 50\text{ mA}$	Fig. 1
Peak Wavelength Temperature Coefficient	$\Delta\lambda/\Delta T$		0.25		nm/ $^\circ\text{C}$	$I_{FDC} = 50\text{ mA}$	
Spectral Width at FWHM	$\Delta\lambda$		37		nm	$I_{FDC} = 50\text{ mA}$	Fig. 1
Optical Rise and Fall Times, 10%-90%	$t_r/t_f$		40		ns	$I_{FPK} = 50\text{ mA}$	
Bandwidth	$f_c$		9		MHz	$I_{FDC} = 50\text{ mA}$ $\pm 10\text{ mA}$	Fig. 11

### HSDL-54XX Absolute Maximum Ratings

Parameter	Symbol	Min.	Max.	Unit
Power Dissipation	$P_{DISS}$		150	mW
Reverse Voltage ( $I_R = 100 \mu A$ )	$V_R$		40	V
Operating Temperature	$T_O$	-40	85	$^{\circ}C$
Storage Temperature	$T_S$	-55	100	$^{\circ}C$
Junction Temperature	$T_J$		110	$^{\circ}C$
Lead Solder Temperature [1.6 mm (0.063 in.) from body]			260/5 s	$^{\circ}C$
Reflow Soldering Temperatures				
Convection IR			235/90 s	$^{\circ}C$
Vapor Phase			215/180 s	$^{\circ}C$

### HSDL-54XX Electrical Characteristics at $T_A = 25^{\circ}C$

Parameter	Symbol	Min.	Typ.	Max.	Unit	Condition	Ref.
Forward Voltage	$V_F$		1.80		V	$I_{FDC} = 50 \text{ mA}$	
Breakdown Voltage	$V_{BR}$	40			V	$I_R = 100 \mu A$ , $E_e = 0 \text{ mW/cm}^2$	
Reverse Dark Current	$I_D$		1	5	nA	$V_R = 5 \text{ V}$ , $E_e = 0 \text{ mW/cm}^2$	Fig. 12
Series Resistance	$R_S$		2000		$\Omega$	$V_R = 5 \text{ V}$ , $E_e = 0 \text{ mW/cm}^2$	
Diode Capacitance	$C_O$		5		pF	$V_R = 0 \text{ V}$ , $E_e = 0 \text{ mW/cm}^2$ $f = 1 \text{ MHz}$	Fig. 16
Open Circuit Voltage	$V_{OC}$		375		mV	$E_e = 1 \text{ mW/cm}^2$ $\lambda_{PK} = 875 \text{ nm}$	
Temperature Coefficient of $V_{OC}$	$\Delta V_{OC}/\Delta T$		-2.2		mV/K	$E_e = 1 \text{ mW/cm}^2$ $\lambda_{PK} = 875 \text{ nm}$	
Short Circuit Current	$I_{SC}$					$E_e = 1 \text{ mW/cm}^2$ $\lambda_{PK} = 875 \text{ nm}$	
HSDL-5400			1.6		$\mu A$		
HSDL-5420			4.3		$\mu A$		
Temperature Coefficient of $I_{SC}$	$\Delta I_{SC}/\Delta T$		0.16		%/K	$E_e = 1 \text{ mW/cm}^2$ $\lambda_{PK} = 875 \text{ nm}$	
Thermal Resistance, Junction to Pin	$R\theta_{JP}$		170		$^{\circ}C/W$		

### HSDL-54XX Optical Characteristics at $T_A = 25^\circ\text{C}$

Parameter	Symbol	Min.	Typ.	Max.	Unit	Condition	Ref.
Photocurrent	$I_{PH}$	0.8	1.6		$\mu\text{A}$	$E_e = 1 \text{ mW/cm}^2$ $\lambda_{PK} = 875 \text{ nm}$ $V_R = 5 \text{ V}$	Fig. 14, 15
HSDL-5400			6.0				
HSDL-5420							
Temperature Coefficient of $I_{PH}$	$\Delta I_{PH}/\Delta T$		0.1		%/K	$E_e = 1 \text{ mW/cm}^2$ $\lambda_{PK} = 875 \text{ nm}$ $V_R = 5 \text{ V}$	Fig. 13
Radiant Sensitive Area	A		0.15		$\text{mm}^2$		
Absolute Spectral Sensitivity	S		0.5		A/W	$E_e = 1 \text{ mW/cm}^2$ $\lambda_{PK} = 875 \text{ nm}$ $V_R = 5 \text{ V}$	
Viewing Angle	$2\theta_{1/2}$		110		deg		Fig. 18
HSDL-5400			28				Fig. 19
HSDL-5420							
Wavelength of Peak Sensitivity	$\lambda_{PK}$		875		nm	$E_e = 1 \text{ mW/cm}^2$ $V_R = 5 \text{ V}$	Fig. 17
Spectral Bandwidth	$\Delta\lambda$		770-1000		nm	$E_e = 1 \text{ mW/cm}^2$ $V_R = 5 \text{ V}$	Fig. 17
Quantum Efficiency	$\eta$		70		%	$E_e = 1 \text{ mW/cm}^2$ $\lambda_{PK} = 875 \text{ nm}$ $V_R = 5 \text{ V}$	
Noise Equivalent Power	NEP		$6.2 \times 10^{-15}$		$\text{W/Hz}^{1/2}$	$V_R = 5 \text{ V}$ $\lambda_{PK} = 875 \text{ nm}$	
Detectivity	D		$6.3 \times 10^{12}$		$\text{cm}^* \text{ Hz}^{1/2}/\text{W}$	$V_R = 5 \text{ V}$ $\lambda_{PK} = 875 \text{ nm}$	
Optical Rise and Fall Times, 10%-90%	$t_r/t_f$		7.5		ns	$V_R = 5 \text{ V}$ $R_L = 1 \text{ k}\Omega$ $\lambda_{PK} = 875 \text{ nm}$	
Bandwidth	$f_c$		50		MHz	$V_R = 5 \text{ V}$ $R_L = 1 \text{ k}\Omega$ $\lambda_{PK} = 875 \text{ nm}$	

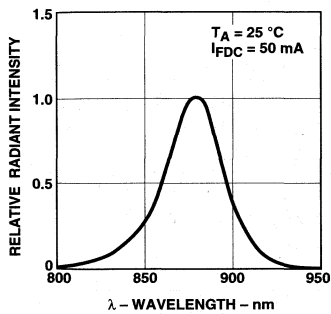

Figure 1. Relative Radiant Intensity vs. Wavelength.

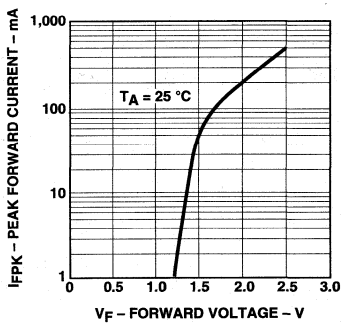

Figure 2. Peak Forward Current vs. Forward Voltage.

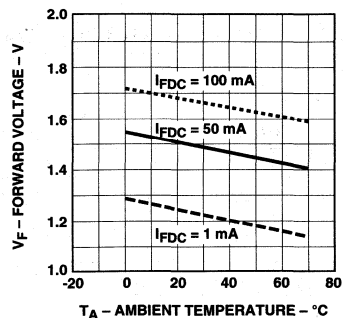

Figure 3. Forward Voltage vs. Ambient Temperature.

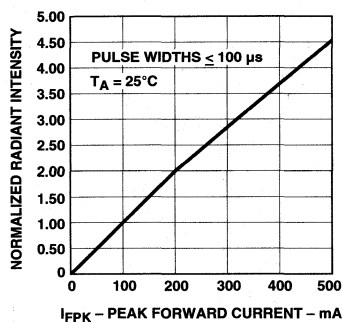

Figure 4. Normalized Radiant Intensity vs. Peak Forward Current.

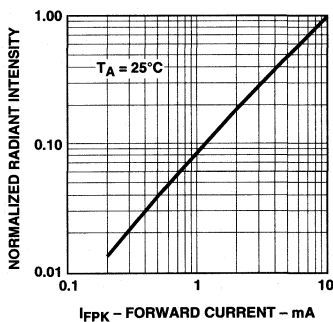

Figure 5. Normalized Radiant Intensity vs. Peak Forward Current (0 to 10 mA).

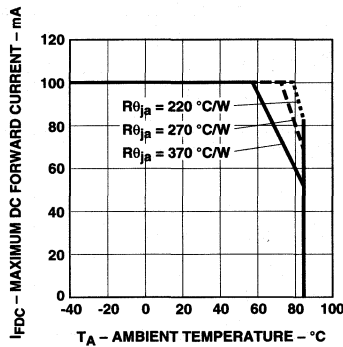

Figure 6. Maximum DC Forward Current vs. Ambient Temperature. Derated Based on  $T_{JMAX} = 110^{\circ}C$ .

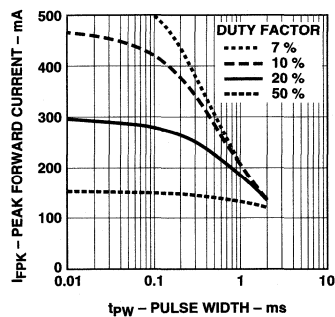

Figure 7. Maximum Peak Forward Current vs. Duty Factor.

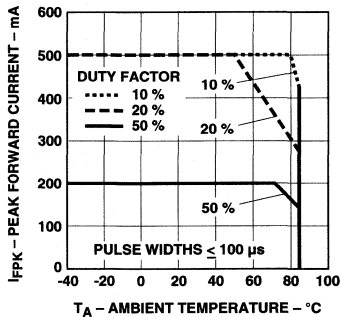

Figure 8. Maximum Peak Forward Current vs. Ambient Temperature. Derated Based on  $T_{JMAX} = 110^{\circ}C$ .

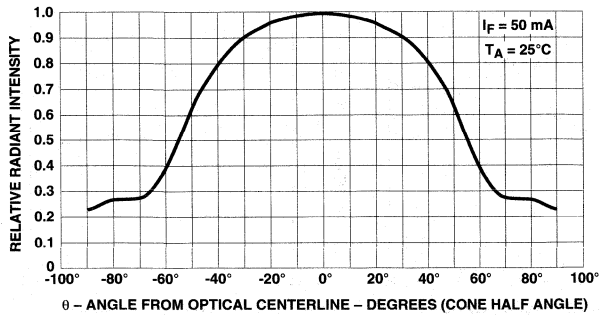

Figure 9. Relative Radiant Intensity vs. Angular Displacement HSDL-4400.

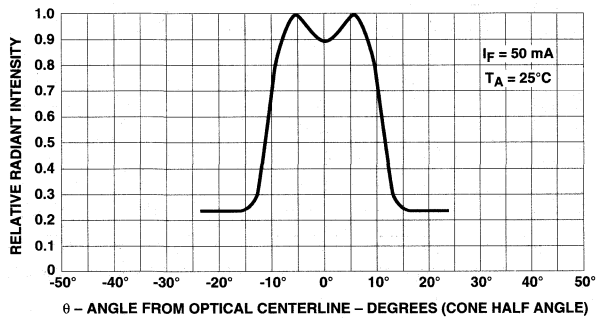

Figure 10. Relative Radiant Intensity vs. Angular Displacement HSDL-4420.

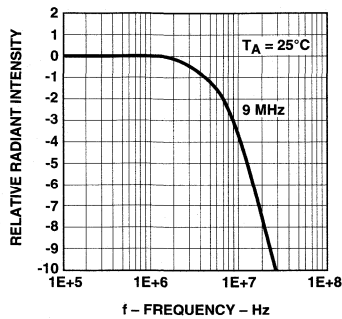

Figure 11. Relative Radiant Intensity vs. Frequency.

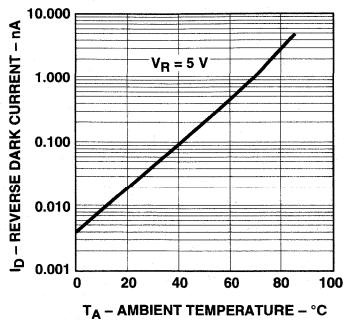

Figure 12. Reverse Dark Current vs. Ambient Temperature.

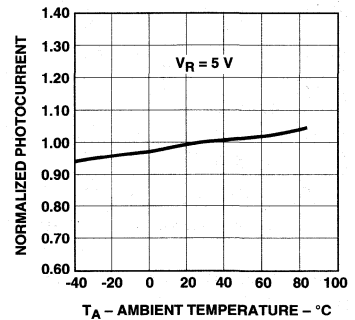

Figure 13. Relative Reverse Light Current vs. Ambient Temperature.

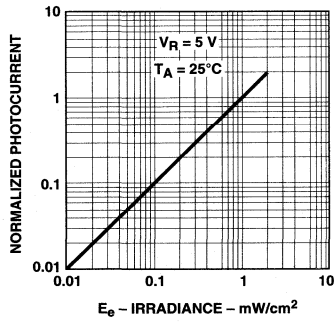

Figure 14. Reverse Light Current vs. Irradiance

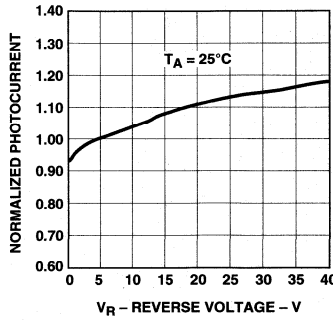

Figure 15. Reverse Light Current vs. Reverse Voltage.

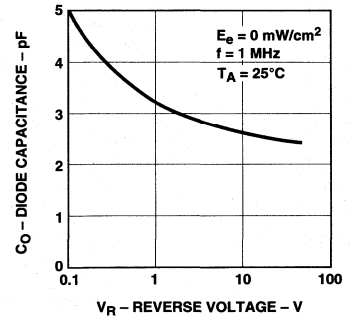

Figure 16. Diode Capacitance vs. Reverse Voltage.

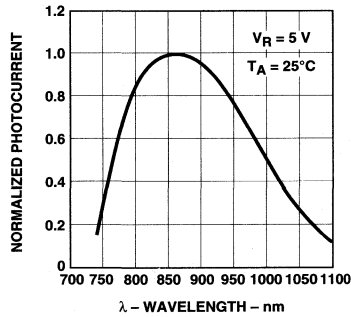

Figure 17. Relative Spectral Sensitivity vs. Wavelength.

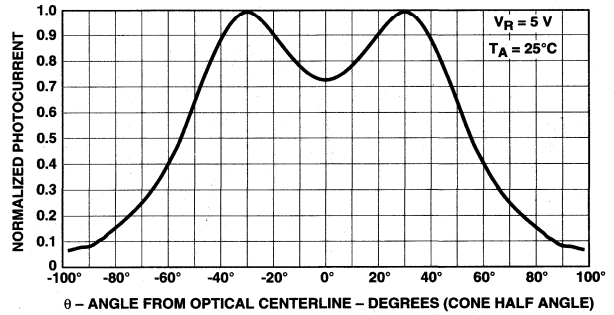

Figure 18. Relative Radiant Intensity vs. Angular Displacement. HSDL-5400.

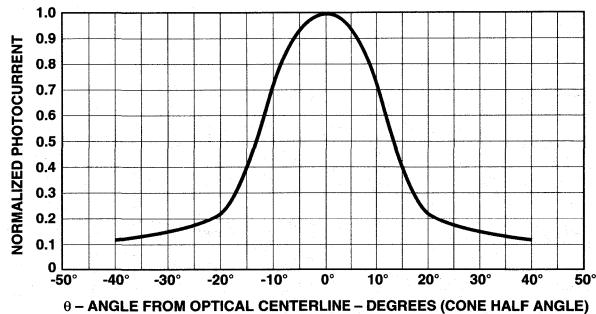
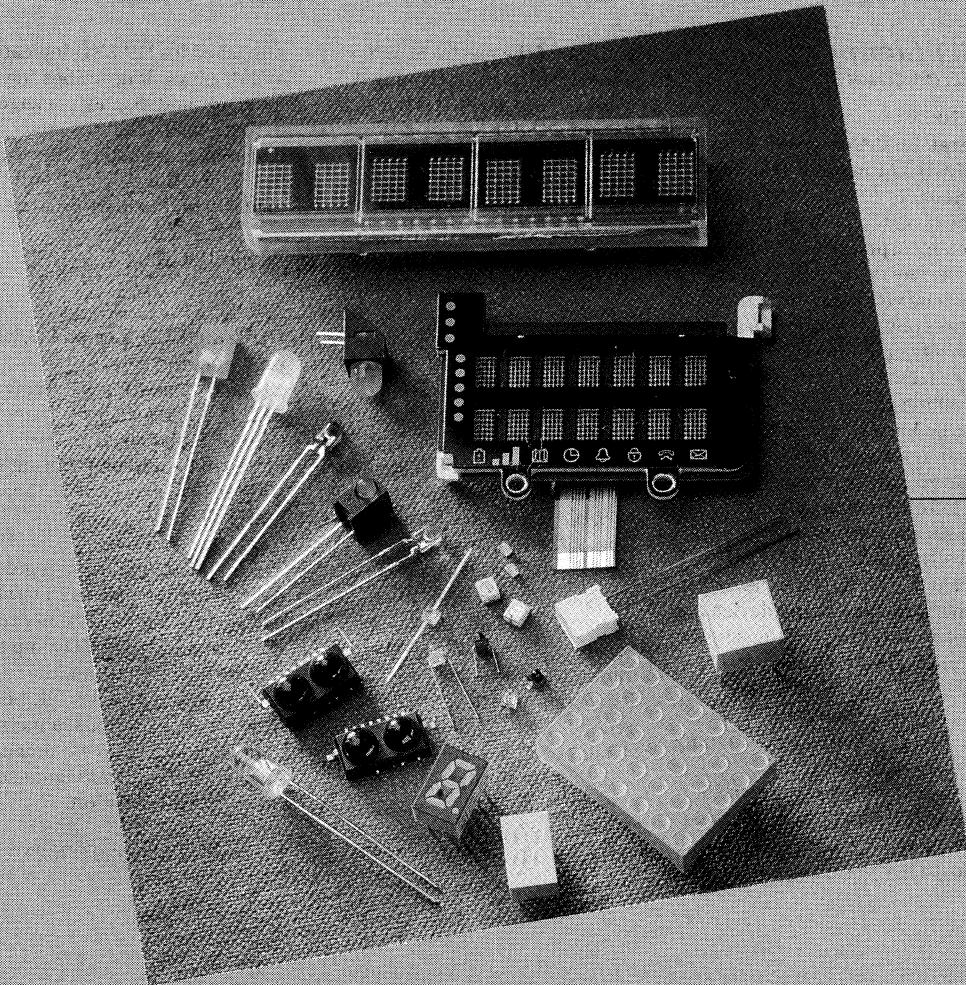

Figure 19. Relative Radiant Intensity vs. Angular Displacement. HSDL-5420.

**Note:** At the time of this publication, Light Emitting Diodes (LEDs) that are contained in this product are regulated for eye safety in Europe by the Commission for European Electrotechnical Standardization (CENELEC) EN60825-1. Please refer to Application Briefs I-008, I-009, I-015 for more information.

# Applications



---

## Applications

*All of the application information listed here is available from your local Hewlett-Packard sales office or nearest Hewlett-Packard authorized distributor or representative (see listing in section 6).*

*In the US/Canada, technical literature is available from the Hewlett-Packard Components Group fax-back service at: 1-800-450-9455, or from the Components Sales Response Center at: 1-800-235-0312 or 408-654-8675.*

---

### **LED Lamps/ Indicators**

#### **AN 1005 Operational Considerations for LED Lamps and Display Devices**

In the design of a display system which incorporates LED lamps and display devices, the objective is to achieve an optimum between light output, power dissipation, reliability, and operating life. The performance characteristics and capabilities of each LED device must be known and understood so that an optimum design can be achieved. The primary source for this information is the LED device data sheet. The data sheet typically contains Electrical/Optical Characteristics that list the performance of the device and Absolute Maximum Ratings in conjunction with characteristic curves and other data which describe the capabilities of the device. A thorough understanding of this information and its intended use provides the basis for achieving an optimum design. This application note presents an in-depth discussion of the theory

and use of the electrical and optical information contained within a data sheet. Two designs using this information in the form of numerical examples are presented, one for dc operation and one for pulsed (strobed) operation.

Publication No. 5091-9704E

#### **AN 1017 LED Solid State Reliability**

Light emitting diode display technology offers many attractive features including multiple display colors, sunlight readability, and a continuously variable intensity adjustment. One of the most common reasons that LED displays are designed into an application, however, is the high level of reliability of the LED display. Hewlett-Packard has taken a leadership role in setting reliability standards for LED displays and documenting reliability performance.

This note explains how to use the reliability data sheets

published for HP LED indicators and displays. It describes the LED indicator and display packages, defines device failures, and discusses parameters affecting useful life, failure rates, and mechanical test performance.

Publication No. 5953-7784

#### **AN 1021 Utilizing LED Lamps Packaged on Tape and Reel**

Hewlett-Packard offers many of its LED lamps packaged on tape and reel for radial insertion by automatic equipment during high volume production of PC board assemblies.

This application note is a guide to the use of tape and reel LED lamps in the automatic insertion process. Discussed are the LED lamp tape and reel configuration, the radial lead insertion process, PC board design considerations, a method to maintain LED lamp alignment during soldering, and lamp stand-off height information.

Publication No. 5964-3921E



**AN 1027****Soldering LED Components**

The modern printed circuit board is assembled with a wide variety of semiconductor components. These components may include LED lamps and displays in combination with other components. The quantity of solder connections will be many times the component count. Therefore, the solder connections must be good on the first pass through the soldering process. The effectiveness of the soldering process is a function of the care and attention paid to the details of the process. It is important for display system designers and PC board assembly engineers to understand the aspects of the soldering process and how they relate to LED components to assure high yields.

This application note provides an in-depth discussion on the aspects of the soldering process and how they relate to LED lamps and display components, with the objective of being to serve as a guide towards achieving high yields for solder connections.

Publication No. 5954-0893

**AN 1060****Surface Mounting SMT LED Indicator Components**

Circuit board assemblies using surface mount technology (SMT) are now common and SMT LED indicators are being used on many of these SMT board assemblies. This application note gives the Standard EIA tape and reel packaging information for SMT LED indicators. Recommended pc board pad layout designs are given for each type of SMT LED component. Automatic placement considerations, solder paste, and Type 2 pc board processing issues are discussed. Recommended temperature profiles are presented for both

convective IR reflow and vapor phase (VPS) reflow soldering processes. A brief discussion of conductive attachment is included. An industry standard rework technique is described in detail.

Publication No. 5091-6704E

**AN 1061****Light Output Degradation of Emerald Green Solid State Lamps**

Emerald Green material has demonstrated a different light output degradation pattern vs. other IIV materials. Differences include larger standard deviation within a sample and suggestions of varied performance from lot-to-lot. This application note reports the observed differences between Standard Green LEDs and Emerald Green LEDs on light output degradation vs. Time. Design Engineers could utilize this information in their applications.

Publication No. 5091-7778E

**AB 74****Auto-Insertion of Option 002 Tape and Reel LED Lamps**

Publication No. 5964-3924E

**AB I-004****Reliability of TS AlInGaP LED Lamps in Traffic Signals and Variable Message Signs**

Publication No. 5964-6223E

**AB I-006****TS AlInGaP LED Amber Lamps for In-Roadway Pedestrian Crosswalk Strobe Lighting**

Publication No. 5964-3904E

**AB I-007****Projection of Long Term Light Output Performance for AS AlInGaP LED Technology**

Publication No. 5964-6228E

**AB I-008****IEC 825-1 and CENELEC EN60825, EN60825-1, Standards for Products with LED Devices**

Publication No. 5963-6974E

**AB I-009****Visible LED Devices and Eye Safety with Respect to MPE Values Defined in the IEC 825-1 and CENELEC EN60825-1 Standards**

Publication No. 5964-3805E

**AB I-010****Packaging and Intensity and Color Binning Options for Precision Optical Performance AlInGaP T-1 3/4 LED Lamps**

Publication No. 5965-0986E

**AB I-011****Full Color LCD Backlighting with LEDs**

Publication No. 5963-7545E

**AB I-012****Temperature Compensation Circuit for Constant LED Intensity**

Publication No. 5963-7544E

**AB I-014****LED Technology in Roadway Work Zone Light Emitting Safety Devices**

Publication No. 5964-9176E

**AB I-015****Visible LED Device Classifications with Respect to AEL Values as Defined in the European CENELEC EN60825-1 Standard**

Publication No. 5964-9499E

## ***Automotive Applications***

### **AB A02**

#### **Benefits of LEDs for Instrument Cluster Lighting**

Publication No. 5964-8918E

### **AB A03**

#### **LED Compatibility with Automotive EMC Transients**

Publication No. 5964-8919E

### **AB A04**

#### **LED Lamp Thermal Properties**

Publication No. 5964-8921E

## ***LED Displays***

### **AN 1006**

#### **Seven Segment LED Display Applications**

This application note begins with a detailed explanation of the two basic product lines that Hewlett-Packard offers in the seven segment display market. This discussion includes mechanical construction techniques, character heights, and typical areas of application. The two major display drive techniques, dc and strobed, are covered. The resultant tradeoffs of cost, power, and ease of use are discussed. This is followed by several typical instrument applications including counters, digital voltmeters, and microprocessor interface applications. Several different microprocessor based drive techniques are presented incorporating both the monolithic and the large seven segment LED displays.

The application note contains a discussion of intensity and color considerations made necessary if the devices are to be end stacked. Hewlett-Packard has made several advances in the area of sunlight viewability of LED displays. The

basic theory is discussed and recommendations made for achieving viewability in direct sunlight. Information concerning display mounting, soldering, and cleaning is presented. Finally, an extensive set of tables has been compiled to aid the designer in choosing the correct hardware to match a particular application. These tables include seven segment decoder/drivers, digit drivers, LSI chips designed for use with LEDs, printed circuit board edge connectors, and filtering materials.

Publication No. 5953-0439

### **AN 1015**

#### **Contrast Enhancement Techniques for LED Displays**

Contrast enhancement is essential to assure readability of LED displays in a variety of indoor and outdoor ambients. Plastic filters are typically used for contrast enhancement with indoor lighting and glass circular polarized filters are typically used to achieve readability in sunlight ambients.

This application note discusses contrast enhancement technology for both indoor and outdoor ambients, the theory of Discrimination Index and provides a list of tested contrast enhancement filters and filter manufacturers.

Publication No. 5964-6129E

### **AN 1016**

#### **Using the HDSP-2000 Alphanumeric Display Family**

The HDSP-2000 family of alphanumeric display products provides the designer with a variety of easy-to-use display modules with on board integrated circuit drivers. The HDSP-2000 family has been expanded to provide three display sizes with

character heights ranging from 3.8 mm (0.15 in.) to 6.9 mm (0.27 in.), four display colors, and both commercial and military versions. These displays can be arranged to create both single line and multiple line alphanumeric panels.

This note is intended to serve as a design and application guide for users of the HDSP-2000 family of alphanumeric display devices. It covers the theory of the device design and operation, considerations for specific circuit designs, thermal management, power derating and heat sinking, and intensity modulation techniques.

Publication No. 5953-7787

### **AN 1026**

#### **Designing with Hewlett-Packard's Smart Display - the HPDL-2416**

The trend in LED Alphanumeric displays is to simplify a designer's job as much as possible by incorporating on board character storage, ASCII character generation, and multiplexing within the display. The HPDL-2416 is a four character alphanumeric display which incorporates a 64 character ASCII decoder and an on board CMOS IC to perform these functions. This application note is intended to serve as a design and application guide for users of the HPDL-2416. The information presented will cover electrical description, electrical design considerations, interfacing to micro-processors, pre-programmed message systems, mechanical and electrical handling, and contrast enhancement.

Publication No. 5954-0936

#### **AN 1029**

##### **Luminous Contrast and Sunlight Readability of the HDSP-238X Series LED Alphanumeric Displays for Military Applications**

Military specifications for avionics and other kinds of electronics that require readability in sunlight use specific definitions for luminous contrast. The concept of chrominance contrast and the theory of Discrimination Index (see Hewlett-Packard Application Note 1015) are not used by the military as a means of determining readability in sunlight. Thus, the military requirements for readability in sunlight are based solely on luminous contrast measurements. This application note discusses the luminous contrasts used by military specifications, describes anti-reflection/circular polarized filters designed for use with the HDSP-238X series sunlight viewable LED displays, and presents luminous contrast data for various HDSP-238X display/filter combinations.

Publication No. 5963-7154E

#### **AN1030**

##### **LED Displays and Indicators and Night Vision Imaging System Lighting**

This application note introduces the concept of night vision imaging. It discusses GEN II and GEN III ANVIS and Cat's Eyes night vision goggles. NVG compatibility problems and compatible lighting objectives for aircraft cockpits are discussed. It illustrates the use of NVG filters with high performance green and yellow LEDs to obtain NVG compatibility. Various aspects of MIL-L-85762A, as they apply to LEDs, are discussed. Calculated NVIS Radiance values are presented for high performance

green and yellow LED/NVG/DV filter combinations. A discussion of the U.S. Army's NVG Secure Lighting Program and the objectives of the CECOM SOW are included. Information on dimming LED displays is presented. Daylight readability with NVG/DV filters is also discussed.

Publication No. 5964-3923E

#### **AN 1031**

##### **Front Panel Design**

In many applications designers are faced with the problem of how to match the perceived brightness of an assortment of seven segment displays, light bars, linear arrays, and lamps on the same front panel. To simplify this problem Hewlett-Packard has introduced S02 option selected parts. S02 option selected parts provide a restricted range of luminous intensity for a given part number. This application note is written as a design guide to matching the perceived brightness of LED displays and lamps on a front panel. The procedure shown in the application note will enable the designer to calculate the needed display drive currents (either dc or pulsed) for a given ambient light level and specified filter. Two techniques are explained. The first is how to calculate the drive currents to insure minimum acceptable brightness. The second is how to calculate the drive currents to match the display on the front panel to a known display.

Publication No. 5954-0933

#### **AN 1033**

##### **Designing with the HDSP-211X Smart Display Family**

Hewlett-Packard's smart alphanumeric display, the HDSP-

211X, is built to simplify the user's display design. Each HDSP-211X has an onboard CMOS IC which displays eight characters. All of the IC features are software driven. These features include 128 character ASCII decoder, 16 user-defined symbols, seven brightness levels, flashing characters, a self test, and all of the circuitry needed to decode, drive, and refresh eight 5 x 7 dot matrix characters.

This application note discusses how to interface the HDSP-211X display to either a Motorola 6808 or an Intel 8085 microprocessor. A 32 character display interface is explained for each microprocessor. The note includes a detailed description of the hardware and software. The software illustrates how the user-defined symbols and a string of ASCII characters are loaded into the display.

Publication No. 5954-8424

#### **AN 1039**

##### **Dimming HDSP-213X Displays to Meet Night Vision Lighting Levels**

###### **Abstract**

For normal operation, the seven programmable dimming levels available with the HDSP-213X military grade displays are sufficient. However, the displays must be dimmed well below the lowest available on-board programmable dimming level to meet the requirements for night vision imaging system (NVIS) lighting. This application note describes a circuit that will dim HDSP-213X displays to luminance levels sufficient to meet NVIS lighting requirements.

Publication No. 5952-0708

**AB D-001**  
**Design-in Tips for Use with**  
**Smart 8-Character**  
**Alphanumeric LED Displays**

Publication No. 5963-7070E

**AB D-002**  
**Interfacing the HCMS-29XX**  
**LED Alphanumeric Displays**  
**with the Intel 8751H**  
**Microcontroller**

Publication No. 5963-7071E

**AB D-003**  
**HCMS-29XX LED Display**  
**Character Set (ASCII and**  
**Katakana)**

Publication No. 5964-2385E

**AB D-004**  
**A Guide to Human Visual**  
**Perception and the Optical**  
**Characteristics of LED**  
**Displays**

Publication No. 5963-7073E

**AB D-005**  
**Interfacing the HDSP-2XXX**  
**LED Alphanumeric Displays**  
**with the Intel 8751H**  
**Microcontroller**

Publication No. 5963-7074E

**AB D-006**  
**Determination of Ics Used in**  
**the HDSP-211X Displays**

Publication No. 5963-7225E

**AB D-007**  
**Solutions for Common LED**  
**Design Errors in Segmented**  
**Display and Multi-Indicator**  
**Applications**

Publication No. 5963-7069E

**AB D-010**  
**Improving Thermal**  
**Performance of LED Tiles in**  
**Outdoor Large Area Displays**

Publication No. 5964-9602E

**AB I-008**  
**IEC 825-1 and CENELEC**  
**EN60825, EN60825-1,**  
**Standards for Products with**  
**LED Devices**

Publication No. 5963-6974E

**AB I-009**  
**Visible LED Devices and Eye**  
**Safety with Respect to MPE**  
**Values Defined in the IEC 825-**  
**I and CENELC EN60825-1**  
**Standards**

Publication No. 5964-3805E

**AB I-015**  
**Visible LED Device**  
**Classifications with Respect to**  
**AEL Values as Defined in the**  
**European CENELEC EN60825-**  
**I Standard**

Publication No. 5964-9499E

## ***Infrared Products***

**AB I-008**  
**IEC 825-1 and CENELEC**  
**EN60825, EN60825-1,**  
**Standards for Products with**  
**LED Devices**

Publication No. 5963-6974E

**AB I-009**  
**Visible LED Devices and Eye**  
**Safety with Respect to MPE**  
**Values Defined in the IEC 825-**  
**1 and CENELEC EN60825-1**  
**Standards**

Publication No. 5964-3805E

**AB I-015**  
**Visible LED Device**  
**Classifications with Respect to**  
**AEL Values as Defined in the**  
**European CENELEC EN60825-**  
**I Standard**

Publication No. 5964-9499E

# Sales and Service

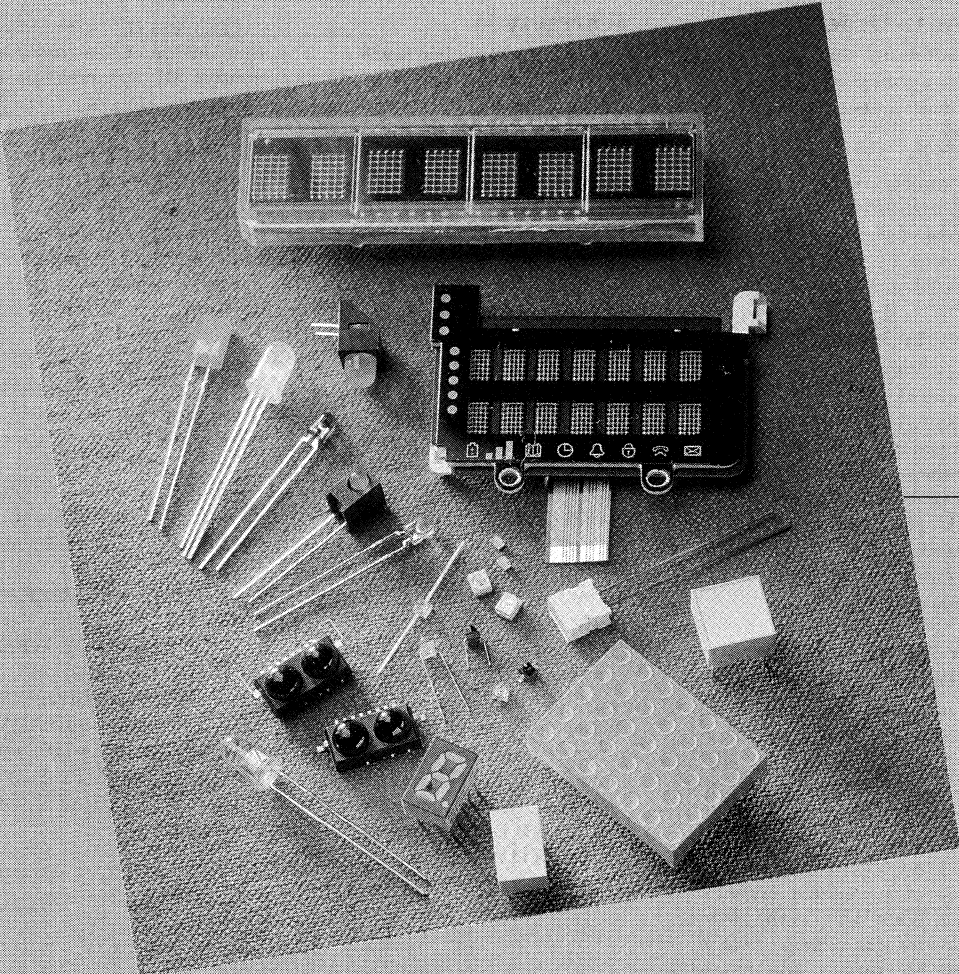

---

## Ordering Information, After-Sales Service

---

### How to Order

To order any component in this catalog, call your nearest HP authorized distributor or HP sales office.

A complete listing of HP authorized distributors is located on page 6-3. These distributors can offer off-the-shelf delivery for most HP components.

### Service and Support

For technical assistance or to find out the location of your nearest HP sales office, distributor or representative call (US and Canada only): 1-800-235-0312 or 408-654-8675. Elsewhere in the world, call your local sales office located in your telephone directory. Ask for a Components representative.

---

### For Additional Information

For additional technical literature not available in this catalog, try our fax-back service (US and Canada only) at: 1-800-450-9455.

Information regarding Hewlett-Packard Components Group products is available on the World Wide Web via the Hewlett-Packard home page at: <http://www.hp.com/> or directly via the Components Group home page at: <http://www.hp.com/go/components/>

### Warranty

a) HP warrants hardware Products against defects in materials and workmanship (in relation to HP's published minimum/maximum specifications or Customer's specifications expressly accepted in writing by HP) for one year from shipment. This warranty extends only to Customer and not to indirect purchasers or users. If HP receives notice of such defects during the warranty period, HP will, at its option, either repair or replace Products which prove to be defective. If HP is unable, within a reasonable time, to repair or replace any Product to a condition as warranted, Customer will be entitled to a refund of the purchase price upon prompt authorized return of the Product to HP.

b) Customer will prepay shipping charges (and will pay all duties and taxes) for Products returned to HP for warranty service. For valid warranty claims, HP will reimburse Customer for prepaid freight charges and return Products to Customer at HP's expense.

c) Unless HP agrees in writing that Customer has configuration control, HP may make process or materials changes affecting the performance or other characteristics of Products. Products supplied after such a change will continue to meet HP's published minimum/maximum specifications, but may not be identical to Products supplied as samples or under prior orders.

d) The foregoing warranty will not apply to defects resulting from: improper or inadequate maintenance; non-HP software or interfacing; unauthorized modification or misuse; or, operation outside HP's published specifications for the Product.

e) THE ABOVE WARRANTIES ARE EXCLUSIVE AND NO OTHER WARRANTY, WHETHER WRITTEN OR ORAL, IS EXPRESSED OR IMPLIED. HP SPECIFICALLY DISCLAIMS THE IMPLIED WARRANTIES OF MERCHANTABILITY AND FITNESS FOR A PARTICULAR PURPOSE.



---

# HP Components Authorized Distributor and Representative Directory

---

**Alabama**

Allied Electronics  
1-800-433-5700

Arrow Electronics  
1015 Henderson Rd.  
Huntsville 35816  
(205) 837-6955

Future Electronics  
4825 University Ave.  
Suite 12  
Huntsville 35816  
(205) 830-2322

Hamilton Hallmark  
4890 University Square  
Suite 1  
Huntsville 35816  
(205) 837-8700

Newark Electronics  
1-800-367-3573

Penstock, Inc.  
1-800-PENSTOC

**Arizona**

Allied Electronics  
1-800-433-5700

Arrow Electronics  
2415 W. Erie Dr.  
Tempe 85282  
(602) 431-0030

Future Electronics  
4636 E. University Dr.  
Suite 245  
Phoenix 85034  
(602) 968-7140

Hamilton Hallmark  
4637 S. 36th Place  
Phoenix 85040  
(602) 437-1200

Newark Electronics  
1-800-367-3573

Penstock, Inc.  
8260 E. Raintree Dr.  
Suite 206  
Scottsdale 85260  
(602) 998-4442

Penstock-Sertek  
2111 East Broadway Rd.  
Suite 5  
Tempe 85282  
(602) 894-9405

**California**

Allied Electronics  
1-800-433-5700

Arrow Electronics  
26677 W. Agoura Rd.  
Calabassas 91302  
(818) 880-9686

Arrow Electronics  
6 Cromwell St.  
Suite 100  
Irvine 92718  
(714) 454-4300

Arrow Electronics  
167 W. Poplar  
Porterville 93257  
(209) 781-4335

Arrow Electronics  
2999 Pacific Commerce Dr.  
Rancho Dominguez 90221  
(310) 639-5393

Arrow Electronics  
9511 Ridgehaven Ct.  
San Diego 92123  
(619) 565-4800

Arrow Electronics  
1180 Murphy Ave.  
San Jose 95131  
(408) 441-9700

Future Electronics  
27489 West Agoura Rd.  
Suite 300  
Agoura Hills 91301  
(818) 865-0040

Future Electronics  
25B Technology  
Suite 200  
Irvine 92718  
(714) 453-1515

Future Electronics  
755 Sunrise Ave.  
Suite 105  
Roseville 95661  
(916) 783-7877

Future Electronics  
5151 Shoreham Place  
Suite 220  
San Diego 92122  
(619) 625-2800

Future Electronics  
2220 O'Toole Ave.  
San Jose 95131  
(408) 434-1122

Hamilton Hallmark  
(Corporate Office)  
10950 W. Washington Blvd.  
Culver City 90230  
(310) 558-2000

Hamilton Hallmark  
140 Technology Drive  
Suite 400  
Irvine 92718  
(714) 641-4100

Hamilton Hallmark  
580 Menlo Dr.  
Suite 2  
Rocklin 95765  
(916) 624-9781

Hamilton Hallmark  
4545 Viewridge Ave.  
San Diego 92123  
(619) 571-7540

Hamilton Hallmark  
2105 Lundy Ave.  
San Jose 95131  
(408) 435-3500

Hamilton Hallmark  
21150 Califa St.  
Woodland Hills 91327  
(818) 594-0404

Newark Electronics  
1-800-367-3573

Penstock, Inc.  
1401 Highland Ave.  
Suite 200  
Manhattan Beach 90266  
(310) 546-8953

Penstock-Sertek, Inc.  
(Corporate Office)  
3481 Old Conejo Rd.  
Newbury Park, CA 91320  
(805) 375-6680

Penstock, Inc.  
5850 Oberlin Dr.  
Suite 208  
San Diego 92121  
(619) 535-3015

Penstock, Inc.  
(Corporate Office)  
520 Mercury Dr.  
Sunnyvale 94086  
(408) 730-0300

Zeus Electronics  
6 Cromwell St.  
Suite 100  
Irvine 92718  
(714) 581-4622

Zeus Electronics  
6276 San Ignacio Ave.  
San Jose 95119  
(408) 629-4789

**Colorado**

Allied Electronics  
1-800-433-5700

Arrow Electronics  
101 Invernes Dr. East  
Englewood 80112  
(303) 799-0258

Future Electronics  
12600 West Colfax Ave.  
Suite B110  
Lakewood 80215  
(303) 232-2008

Hamilton Hallmark  
12503 East Euclid Dr.  
Suite 20  
Englewood 80111  
(303) 790-1662

Newark Electronics  
1-800-367-3573

Penstock-Sertek, Inc.  
12503 E. Euclid Ave.  
Suite 20  
Englewood 80111  
(303) 421-7161

#### Connecticut

Arrow Electronics  
860 N. Main St.  
Wallingford 06492  
(203) 265-7741

Future Electronics  
Westgate Office Center  
700 West Johnson Ave.  
Cheshire 06410  
(203) 250-0083

Hamilton Hallmark  
1157 Highland Ave.  
Suite 207  
Cheshire 06410  
(203) 271-5700

Newark Electronics  
1-800-367-3573

Penstock, Inc.  
1-800-PENSTOC

#### Florida

Allied Electronics  
1-800-433-5700

Arrow Electronics  
Summit Executive Suites  
13575 58th St.  
Suite 145  
Clearwater 34620  
(407) 333-9300

Arrow Electronics  
400 Fairway Dr. Suite 201  
Deerfield Beach 33441  
(305) 429-8200

Arrow Electronics  
37 Skyline Dr.  
Suite 3101  
Lake Mary 32746  
(407) 333-9300

Future Electronics  
237 S. Westmonte Dr.  
Suite 307  
Altamonte Springs 32714  
(407) 865-7900

Future Electronics  
1400 E. Newport Center Dr.  
Suite 200  
Deerfield Beach 33442  
(305) 426-4043

Future Electronics  
2200 Tall Pines Dr.  
Suite 108  
Largo 34641  
(813) 530-1222

Future Electronics  
1435 Market St.  
Tallahassee 32312  
1-800-288-1019

Hamilton Hallmark  
3350 NW. 53rd St.  
Suite 105-107  
Ft. Lauderdale 33309  
(305) 484-5482

Hamilton Hallmark  
10491 72nd St. North  
Largo 34647  
(813) 541-7440

Hamilton Hallmark  
7079 University Blvd.  
Winter Park 32792  
1-800-332-8638

Newark Electronics  
1-800-367-3573

Penstock, Inc.  
1726 E. 7th Ave.  
Suite 8  
Tampa 33605  
(813) 247-7556

Zeus Electronics  
37 Skyline Dr.  
Suite 3101  
Lake Mary 32746  
(407) 333-3055

#### Georgia

Allied Electronics  
1-800-433-5700

Arrow Electronics  
4250 E. River Green Pkwy.  
Duluth 30136  
(404) 497-1300

Future Electronics  
3150 Holcomb Bridge Rd.  
Suite 130  
Norcross 30071  
(404) 441-7676

Hamilton Hallmark  
3425 Corporate Way  
Suite A  
Duluth 30136  
(404) 623-4400

Newark Electronics  
1-800-367-3573

Penstock, Inc.  
6825 Jimmy Carter Blvd.  
Suite 1590  
Norcross 30071  
(404) 951-0300

#### Illinois

Allied Electronics  
1-800-433-5700

Arrow Electronics  
1140 West Thorndale Ave.  
Itasca 60143  
(708) 250-0500

Future Electronics  
3150 W. Higgins Rd.  
Suite 160  
Hoffman Estates 60195  
(708) 882-1255

Hamilton Hallmark  
3030 Salt Creek Lane  
Suite 300  
Arlington Heights, 60005  
(708) 797-7300

Hamilton Hallmark  
1130 Thorndale Ave.  
 Bensenville 60106  
(708) 860-7780

Newark Electronics  
(Corporate Office)  
4801 N. Ravenswood Ave.  
Chicago 60640  
1-800-367-3573

Penstock, Inc.  
1250 West Northwest Hwy  
Suite 509  
Palatine 60067  
(708) 934-3700

#### Indiana

Allied Electronics  
1-800-433-5700

Arrow Electronics  
7108 Lake View Pkwy W. Dr.  
Indianapolis 46268  
(317) 299-2071

Future Electronics  
8425 Woodfield Crossing  
Suite 175  
Indianapolis 46240  
(317) 469-0447

Hamilton Hallmark  
655 W. Carmel Dr.  
Suite 160  
Carmel 46032  
(317) 575-3535

Newark Electronics  
1-800-367-3573

Penstock, Inc.  
1-800-PENSTOC

#### Iowa

Allied Electronics  
1-800-433-5700

Hamilton Hallmark  
1-800-254-2847

Newark Electronics  
1-800-367-3573

Penstock, Inc.  
1-800-PENSTOC

#### Kansas

Allied Electronics  
1-800-433-5700

Arrow Electronics  
9801 Legler Rd.  
Lenexa 66219  
(913) 451-9542

Future Electronics  
8826 Santa Fe Dr.  
Suite 150  
Overland Park 66212  
(913) 649-1531

Hamilton Hallmark  
9200 Indian Cr. Pkwy.  
Overland Park 66204  
(913) 663-7900

Newark Electronics  
1-800-367-3573

Penstock, Inc.  
300 S. Clairborne, Suite #A2  
Olathe 66062  
(913) 829-9330

#### Kentucky

Allied Electronics  
1-800-433-5700

Hamilton Hallmark  
1847 Mercer Rd.  
Suite G  
Lexington 40511  
1-800-235-6039

Newark Electronics  
1-800-367-3573

Penstock, Inc.  
1-800-PENSTOC

#### Maryland

Allied Electronics  
1-800-433-5700

Arrow Electronics  
9800 Patuxent Woods Dr.  
Suite J  
Columbia 21046  
(301) 596-7800



Future Electronics  
6716 Alexander Bell Dr.  
Suite 101  
Columbia 21046  
(410) 290-0600

Hamilton Hallmark  
7134 Columbia Gateway Dr.  
Columbia 21046  
(410) 720-3400

Newark Electronics  
1-800-367-3573

Penstock, Inc.  
9881 Broken Land Pkwy.  
Suite 105  
Columbia 21046  
(410) 290-3746

#### **Massachusetts**

Allied Electronics  
1-800-433-5700

Arrow Electronics  
25 Upton Dr.  
Wilmington 01887  
(508) 658-0900

Future Electronics  
41 Main St.  
Bolton 01740  
(508) 779-3000

Hamilton Hallmark  
10D Centennial Dr.  
Peabody 01960  
(508) 532-9893

Newark Electronics  
1-800-367-3573

Penstock  
60 Burlington Mall Rd.  
Suite 310  
(617) 229-9100

Zeus Electronics  
25 Upton Dr.  
Wilmington 01876  
(508) 658-4776

#### **Michigan**

Allied Electronics  
1-800-433-5700

Arrow Electronics  
44720 Helm St.  
Plymouth 48170  
(313) 455-0850

Future Electronics  
4505 Broadmoor SE  
Grand Rapids 49512  
(616) 698-6800

Future Electronics  
35200 Schoolcraft Rd.  
Suite 106  
Livonia 48150  
(313) 261-5270

Hamilton Hallmark  
44191 Plymouth Oaks Blvd.  
Plymouth 48170  
(313) 416-5800

Newark Electronics  
1-800-367-3573

Penstock, Inc.  
1-800-PENSTOC

#### **Minnesota**

Allied Electronics  
1-800-433-5700

Arrow Advantage  
10120A West 76th  
Eden Prairie, MN 55344  
(612) 946-4820

Arrow Electronics  
10100 Viking Dr.  
Suite 100  
Eden Prairie 55344  
(612) 828-7140

Future Electronics  
10025 Valley View Rd.  
Suite 196  
Eden Prairie 55344  
(612) 944-2200

Hamilton Hallmark  
9401 James Ave., South  
Suite 140  
Bloomington 55431  
(612) 881-2600

Newark Electronics  
1-800-367-3573

Penstock, Inc.  
1-800-PENSTOC

#### **Missouri**

Allied Electronics  
1-800-433-5700

Future Electronics  
12125 Woodcrest  
Executive Dr.  
Suite 220  
St. Louis 63141  
(314) 469-6805

Hamilton Hallmark  
3783 Rider Trail South  
Earth City 63045  
(314) 291-5350

Newark Electronics  
1-800-367-3573

Penstock, Inc.  
1-800-PENSTOC

#### **New Jersey**

Allied Electronics  
1-800-433-5700

Arrow Electronics  
4 East Stow Rd.  
Unit 11  
Marlton 08053  
(609) 596-8000

Arrow Electronics  
43 Route 46 East  
Pine Brook 07058  
(201) 227-7880

Future Electronics  
1259 Route 46 East  
Parsippany 07054  
(201) 299-0400

Hamilton Hallmark  
One Keystone Ave.  
Bldg. 36  
Cherry Hill 08003  
(609) 424-0110

Hamilton Hallmark  
10 Lanidex Plaza West  
Parisippany 07054-2715  
(201) 515-5370

Newark Electronics  
1-800-367-3573

Penstock, Inc.  
160 Littleton Rd.  
Suite 201  
Parsippany 07054  
(201) 299-0323

#### **New Mexico**

Allied Electronics  
1-800-433-5700

Newark Electronics  
1-800-367-3573

Penstock-Sertek, Inc.  
(602) 894-9405

Hamilton Hallmark  
2601 Wyoming Blvd. NE  
Albuquerque 87109  
(505) 293-5119

#### **New York**

Allied Electronics  
1-800-433-5700

Arrow Electronics  
(Corporate Office)  
25 Hub Dr.  
Melville 11747  
(516) 391-1300  
(Military)

Arrow Electronics  
3375 Brighton-Henrietta  
Townline Rd.  
Rochester 14609  
(716) 427-0300

Future Electronics  
801 Motor Pkwy.  
Hauppauge 11788  
(516) 234-4000

Future Electronics  
300 Linden Oaks  
Rochester 14625  
(716) 387-9550

Future Electronics  
200 Salina Meadows Pkwy.  
Suite 130  
Syracuse 13212  
(315) 451-2371

Hamilton Hallmark  
390 Rabro Dr.  
Hauppauge 11788  
(516) 434-7400

Hamilton Hallmark  
1057 East Henrietta Rd.  
Rochester 14623  
(716) 475-9130

Newark Electronics  
1-800-367-3573

Penstock, Inc.  
527 Townline Rd.  
Suite 200  
Hauppauge, 07054  
(516) 724-9580

Zeus Electronics  
100 Midland Ave.  
Port Chester 10573  
(914) 937-7400

#### **North Carolina**

Allied Electronics  
1-800-433-5700

Arrow Electronics  
5240 Green Dairy Rd.  
Raleigh 27604  
(919) 876-3132

Future Electronics  
5225 Capital Blvd.  
1 North Commerce Center  
Raleigh 27604  
(919) 790-7111

Hamilton Hallmark  
5234 Greens Dairy Rd.  
Raleigh 27604  
(919) 872-0712

Newark Electronics  
1-800-367-3573

Penstock, Inc.  
1-800-PENSTOC

#### Ohio

Allied Electronics  
1-800-433-5700

Arrow Electronics  
8200 Washington Village Dr.  
Suite A  
Centerville 45458  
(513) 435-5563

Arrow Electronics  
6573E Cochran Rd.  
Solon 44139  
(216) 248-3990

Future Electronics  
1430 Oak Court  
Suite 203  
Beavercreek 45430  
(513) 426-0090

Future Electronics  
6009 E Landerhaven Dr.  
Mayfield Heights 44124  
(216) 449-6996

Hamilton Hallmark  
30775 Bainbridge Rd.  
Solon 44139  
(216) 498-1100

Hamilton Hallmark  
777 Dearborn Park Lane  
Suite L  
Worthington 43085  
(614) 888-3313

Newark Electronics  
1-800-367-3573

Penstock, Inc.  
1-800-PENSTOC

#### Oklahoma

Allied Electronics  
1-800-433-5700

Arrow Electronics  
12111 E. 51st St.  
Suite 101  
Tulsa 74146  
(918) 252-7537

Hamilton Hallmark  
12206 E. 51st St.  
Suite 103  
Tulsa 74146  
(918) 459-6000

Newark Electronics  
1-800-367-3573

Penstock, Inc.  
1-800-PENSTOC

#### Oregon

Allied Electronics  
1-800-433-5700

Almac/Arrow Electronics  
9500 SW Nimbus Ave.  
Bldg. E  
Beaverton 97008  
(503) 629-8090

Future Electronics  
Cornell Oaks Corp. Center  
15236 NW Greenbrier Pkwy.  
Beaverton 97006  
(503) 645-9454

Hamilton Hallmark  
9750 W. S.W. Nimbus Ave.  
Beaverton 97005  
(503) 526-6200

Newark Electronics  
1-800-367-3573

Penstock, Inc.  
1-800-PENSTOC

#### Pennsylvania

Allied Electronics  
1-800-433-5700

Hamilton Hallmark  
1-800-254-2847

Newark Electronics  
1-800-367-3573

Penstock, Inc.  
40 Croce Lane  
Coatesville 19320  
(215) 383-9536

#### Texas

Allied Electronics  
1-800-433-5700

Allied Electronics  
7410 Pebble Dr.  
Fort Worth 76118  
(817) 595-6487

Arrow Electronics  
11500 Metric Blvd.  
Suite 160  
Austin 78758  
(512) 835-4180

Arrow Electronics  
3220 Commander Dr.  
Carrollton 75006  
(214) 380-6464

Arrow Electronics  
19416 Park Row  
Suite 190  
Houston 77084  
(713) 647-6868

Future Electronics  
9020 II Capital of Texas  
Highway North  
Suite 610  
Austin 78759  
(512) 502-0991

Future Electronics  
10333 Richmond Ave.  
Suite 970  
Houston 77042  
(713) 785-1155

Future Electronics  
800 E. Campbell  
Suite 130  
Richardson 75081  
(214) 437-2437

Hamilton Hallmark  
12211 Technology Blvd.  
Austin 78727  
(512) 258-8848

Hamilton Hallmark  
11420 Pagemill Rd.  
Dallas 75243  
(214) 553-4300

Hamilton Hallmark  
1406 North 28th  
Suite 105  
Harlington 78550  
(210) 412-2047

Hamilton Hallmark  
10500 Richmond Ave.  
Suite 112  
Houston 77042  
(713) 781-6100

Newark Electronics  
1-800-367-3573

Penstock, Inc.  
1411 E. Campbell Rd.  
Suite 400  
Dallas, 75081  
(214) 479-9215

Zeus Electronics  
3220 Commander Dr.  
Carrollton 75006  
(214) 783-7010

#### Utah

Allied Electronics  
1-800-433-5700

Arrow Electronics  
1946 W. Parkway Blvd.  
Salt Lake City 84119  
(801) 973-6913

Future Electronics  
3450 So. Highland Dr.  
Suite 301  
Salt Lake City 84106  
(801) 467-4448

Hamilton Hallmark  
1100 East 6600 South  
Suite 120  
Salt Lake City 84121  
(801) 266-2022

Newark Electronics  
1-800-367-3573

Penstock-Sertek, Inc.  
1-800-PENSTOC

#### Washington

Allied Electronics  
1-800-433-5700

Almac/Arrow Electronics  
14360 S.E. Eastgate Way  
Bellevue 98007-6458  
(206) 643-9992

Future Electronics  
19102 North Creek Pkwy.  
Suite 118  
Bothell 98011  
(206) 489-3400

Hamilton Hallmark  
8214 154th Ave.  
Redmond 98052  
(206) 882-7000

Newark Electronics  
1-800-367-3573

Penstock, Inc.  
10800 N.E. 8th St.  
Suite 805  
Bellevue 98004  
(206) 454-2371

#### Wisconsin

Allied Electronics  
1-800-433-5700

Arrow Electronics  
200 North Patrick Blvd.  
Suite 100  
Brookfield 53045  
(414) 792-0150

Future Electronics  
250 N. Patrick Blvd.  
Suite 170  
Brookfield 53045  
(414) 797-0244

Hamilton Hallmark  
2440 South 179th St.  
New Berlin 53146  
(414) 797-7844

Newark Electronics  
1-800-367-3573

Penstock, Inc.  
1-800-PENSTOC

## International

### Australia

Avnet VSI Electronics Pty  
Ltd<sup>[1,2,3,4]</sup>  
Unit 8, 27 College Road  
Kent Town  
SA 5067  
(61) 8-3620944

Avnet VSI Electronics Pty  
Ltd<sup>[1,2,3,4]</sup>  
Unit C, 6-8 Lyon Park Road  
PO Box 888  
North Ryde NSW 2113  
(61) 2-98781299

Avnet VSI Electronics Pty  
Ltd<sup>[1,2,3,4]</sup>  
Unit 12 Business Park Drive  
Monash Business Park  
Notting Hill  
Vic 3168  
(61) 3-5589333

Avnet VSI Electronics Pty  
Ltd<sup>[1,2,3,4]</sup>  
Suite 9, Argyle Place  
Cnr. Sandgate Road & Argyle  
Street  
Breakfast Creek  
QLD 4010  
(61) 7-2625200

Avnet VSI Electronics Pty  
Ltd<sup>[1,2,3,4]</sup>  
69 Walters Drive  
Osborne Park  
WA 6017  
(61) 9-2424266

### Austria

BFI IBEXSA Elektronik  
GmbH<sup>[2,3]</sup>  
Korbinianstr. 6  
85386 Eching (München)  
(49) 89 319 51 35

EBV Elektronik<sup>[1,2]</sup>  
Diefenbachgasse 35/6  
1150 Vienna  
(43) 1 894 1774

ELBATEX GmbH<sup>[1,2]</sup>  
Eitnergasse 6  
1231 Vienna  
(43) 1 86642-0

EURODIS Electronics<sup>[1,2]</sup>  
Lamezanstrasse 10  
1232 Vienna  
(43) 1 61062

### Notes:

1. Optoelectronics
2. RF Diodes/Transistors
3. Microwave and Avantek Products
4. Fiberoptics Components

### Belarus

BelHard  
Melnicyte str. 2-709  
220004 Minsk  
+7 172 239 010

### Belgium

BFI IBEXSA BV<sup>[2,3]</sup>  
PO Box 3019  
2130 KA Hoofddorp  
Netherlands  
(31) 020 65 31 350

EBV Elektronik<sup>[1,2]</sup>  
Excelsiorlaan 35  
Avenue Excelsior 35  
1930 Zaventem  
(32) 02 716 00 10

SEI Rodelco N.V./S.A.<sup>[1,2]</sup>  
Limburg Strium 243  
1780 Wemmel  
(32) 02 460 05 60

### Brazil

Intertek Electronica Ltd.<sup>[1,2]</sup>  
Rua Miguel Casagrande, 200  
02714-000, Sao Paulo, SP  
(011) 266-2922

### Bulgaria

MACRO Sofia<sup>[1,2]</sup>  
116 Geo Millev Str.  
BL 57 AP70  
1574 SOFIA  
(359) 2 708140

### Canada

Arrow<sup>[1,2]</sup>  
8544 Baxter Place  
Burnaby, B.C.  
V5A 4T4  
(604) 421-2333

Arrow  
1000 St. Regis  
Dorval, Quebec H9P 2T5  
(514) 421-7411

Arrow<sup>[1,2]</sup>  
1093 Meyerside Drive  
Mississauga, Ontario  
L5T 1M4  
(905) 670-7769

Arrow<sup>[1,2]</sup>  
36 Antares Drive  
Unit 100  
Nepean, Ontario  
K2E 7W5  
(613) 226-6903

Future Electronics<sup>[1,2]</sup>  
2015 32nd N.E., Unit #1  
Calgary, Alberta  
T2E 6Z3  
(403) 250 5551

Future Electronics<sup>[1,2]</sup>  
5935 Airport Road, Suite 200  
Mississauga, Ontario  
L4V 1W5  
(905) 612 9200

Future Electronics<sup>[1,2]</sup>  
1050 Baxter Road  
Ottawa, Ontario  
K2C 3P2  
(613) 820 8313

Future Electronics<sup>[1,2]</sup>  
237 Hymus Blvd.  
Pointe Claire, Quebec  
H9R 5C7  
(514) 694-7710

Future Electronique Inc  
1000 Avenue St. Jean Baptiste  
Suite 100  
Quebec, Quebec G2E 5G5  
(418) 877-6671

Future Electronics<sup>[1,2]</sup>  
1695 Boundary Road  
Vancouver, B.C.  
V5K 4X7  
(604) 294-1166

Hamilton/Hallmark<sup>[1,2]</sup>  
8610 Commerce Court  
Burnaby, BC V5A 4N6  
(604) 420-4101

Hamilton/Hallmark<sup>[1,2]</sup>  
151 Superior Blvd.  
Unit 1-6  
Mississauga,  
Ontario L5T 2L1  
(905) 564-6060

Hamilton/Hallmark<sup>[1,2]</sup>  
190 Colonnade Road  
Nepean, Ontario K2E 7J5  
(613) 226-1700

Hamilton/Hallmark<sup>[1,2]</sup>  
7575 Trans Canada Highway  
Suite 600  
Ville St. Laurent, Quebec  
H4T 1V6  
(514) 335-1000

Penstock  
RF/Microwave Distribution  
10800 N.E. 8th St.  
Suite 805  
Bellevue, WA 98004

Penstock  
RF/Microwave Distribution  
313 - 260 Hearst Way  
Kanata, Ont. K2L 3H1  
(613) 592-6088

Penstock Inc.<sup>[2,3]</sup>  
1296 Ludbrook Court  
Mississauga, Ontario  
L5J 3N9  
(905) 403-0724

Penstock  
RF/Microwave Distribution  
500 - 7575 Transcanada Hwy  
St. Laurent, Quebec H4T 1V6  
(514) 333-8837

### Czech Republic

GM Electronic<sup>[1,2,3]</sup>  
Evropska 73  
160-00 Praha 6  
(42) 2 316 7202

MACRO Weil s.r.o.<sup>[1,2]</sup>  
Bechynova 3  
160-00 Praha 6  
(42) 2 3112 182

SEI elbatex<sup>[1,2]</sup>  
Prechodni 11  
140 00 Praha 4  
(42) 2 692 8087

### Denmark

Arrow-Exatec A/S<sup>[1,2,4]</sup>  
Mileparken 20E  
DK-2740 Skovlunde  
+45 (44) 92 70 00

Avnet Nortec A/S<sup>[1,2]</sup>  
Transformervej 17  
DK-2730 Herlev  
+45 (44) 88 08 00

BFI-IBEXSA Denmark A/S<sup>[2,3]</sup>  
Langebjergsvenget 8A, 1.TH  
DK-4000 Roskilde  
+45 (46) 75 31 31

### Estonia

Arrow-Field Eesti AS<sup>[1,2]</sup>  
(tuba 301)  
Akadeemia tee 19  
ee 0026 Tallinn  
372-2-588288

### Finland

Arrow-Field Oy<sup>[1,2]</sup>  
Niittylantie 5  
00620 Helsinki  
(358) 0 777571

Avnet Nortec Oy<sup>[1,2]</sup>  
Italahdenkatu 18 A  
00210 Helsinki  
(358) 0 613181

## France

Arrow Electronique SA<sup>[1,2]</sup>  
73/79 rue des Solets  
Silic 585  
94668 Rungis Cedex  
(33) 1 49 78 49 78

Avnet-Composants<sup>[1,2]</sup>  
79, rue Pierre Semard  
BP 90  
92150 CHANTILLON CEDEX  
(1) 49 65 25 00

BFI-IBEXSA Electronique  
SA<sup>[2,3]</sup> Division Scie-Dimes  
1, rue Lavoisier ZI  
91430 Igny  
(33) 1 69 33 74 00

EBV Elektronik<sup>[2]</sup>  
Parc Club de la Haute Maison  
16, rue Gallilée  
Cité Descartes  
77436 Champs sur Marne  
(33) 1 64 68 86 00

Elenix<sup>[2,3]</sup>  
9, rue des Petits Ruisseaux  
91370 Verriere le Buisson  
(33) 1 60 11 94 71

RADIO SPARES  
Composants<sup>[1,2]</sup>  
Rue Norman King  
BP 453  
60031 Beauvais Cedex  
(33) 16 44 84 72 72

SEI S.C.A.I.B. S.A.<sup>[1,2]</sup>  
6 rue Ambroise Croizat  
ZI des Glaises  
BP58  
91127 Palaiseau Cedex  
(33) 1 69 19 89 00

## Germany

AVNET E2000<sup>[1,2]</sup>  
Stahlgruberring 12  
81829 München  
89 45 110-01

BFI IBEXSA Elektronik  
GmbH<sup>[2,3,4]</sup>  
Korbinianstr. 6  
85386 Eching  
89 319 76 70

EBV-Elektronik GmbH<sup>[1,2,3]</sup>  
Hans-Pinsel-Strasse 4  
85540 Haar bei München  
89 456 10 0

## Notes:

1. Optoelectronics
2. RF Diodes/Transistors
3. Microwave and AvanteK Products
4. Fiberoptics Components

Farnell GmbH<sup>[1,2]</sup>  
Grünwalderweg 30  
82041 Deisenhofen  
89 613 39 11

Ing.-Büro K.-H. Dreyer<sup>[1,2]</sup>  
Albert-Schweitzer-Ring 36  
22045 Hamburg  
40 66 952 27-28

SEI Jermyn<sup>[1,2]</sup>  
Im Dachsstück 9  
65549 Limburg  
64 31 508-0

SASCO GmbH<sup>[1,2]</sup>  
Hermann-Oberth-Str. 16  
85640 Putzbrunn bei  
München  
89 46 11-0

## Greece

Micronics Ltd.<sup>[1,2,3]</sup>  
46, Kritis Street  
16451 Argroupolis  
Athens  
(30) 1 9914 786

## Hong Kong

CET Ltd.<sup>[1,2,3,4]</sup>  
1108-1112  
Metropolis Tower 2  
223 Hing Fong Road  
Kwai Fong  
(852) 2485-3899

## Hungary

EURODIS Electronics<sup>[1,2]</sup>  
Lamezanstrasse 10  
1232 Vienna  
Austria  
(43) 1 61062 115

MACRO Budapest Kft.<sup>[1,2]</sup>  
Etele ut 68  
1115 Budapest  
(36) 1 203 0277

SEI elbatex<sup>[1,2]</sup>  
Vaci ut 202  
1138 Budapest  
(36) 1 140 91 94

## India

Hinditron Services Pte Ltd<sup>[2,3]</sup>  
33/44A 8th Main Road  
Rajmahal Vilas Extension  
Bangalore 560 080  
(91) 80-340068/348266

Hinditron Services Pte Ltd<sup>[2,3]</sup>  
Industry House 23-B  
Mahal Industrial Estate  
Mahakali Caves Road  
Andheri (East)  
Bombay 400093  
(91) 22-8364560

Skag India<sup>[1,4]</sup>  
22 Richmond Road  
Bangalore 560025  
(91) 80-2270497

Skag India<sup>[1,4]</sup>  
125 Antriksh Bhawan  
Kasturba Ghandhi Marg  
New Delhi 110001  
(91) 11-6989118

## Israel

CMS<sup>[2,3]</sup>  
Computation &  
Measurement Systems Ltd.  
11, Hashlosa Street  
P.O. Box 25089  
IL-Tel-Aviv, 67060  
(972) 3 537 5055

Gallium<sup>[1,4]</sup>  
11 Hasadna St.  
43650 Ra'anana  
+972 9 982 182

Opcom<sup>[2,3]</sup>  
PO Box 3352  
49130 Petach-Tikva  
+972 3 921 1730

Telsys Ltd.<sup>[1,2]</sup>  
Atidim, Industrial Park,  
Bldg 3  
Dvora Hanevia Street, Neve  
Sharet  
61431 Tel-Aviv  
(972) 3 49 20 01

## Italy

Avnet EMG Divisione  
Adelsy<sup>[1,2]</sup>  
Via Novara 570  
20153 Milano  
(02) 38 10 31 00

Avnet EMG Divisione De  
Mico<sup>[1,2]</sup>  
Viale Vittorio Veneto 8  
20060 Cassina de' Pecchi MI  
(02) 95 34 36 00

BFI IBEXSA SPA<sup>[2,3,4]</sup>  
Via Massena 18  
20145 Milano  
(02) 33 10 05 35

LASI Elettronica S.p.A.<sup>[1,2]</sup>  
Viale Fulvio Testi 280  
20126 Milano  
(02) 66 10 1370

Silverstar Ltd.<sup>[1,2]</sup>  
Viale Fulvio Testi 280  
20126 Milano  
(02) 66 12 51

## Japan

Ryoyo Electro  
Corporation<sup>[1,2,3,4]</sup>  
Konwa Bldg.  
1-12-22, Tsukiji  
Chuo-ku, Tokyo 104  
(81) 3-3546-5011

Ryoyo Electro  
Corporation<sup>[1,2,3,4]</sup>  
Nagoya AT Bldg.  
1-18-22, Nishiki, Naka-ku,  
Nagoya-shi, Aichi 460  
(81) 52-203-0277

Ryoden Trading Co.,  
Limited<sup>[1,2,3,4]</sup>  
Shin-Osaka Center Bldg.  
4-1-4 Miyahara  
Yodogawa-Ku  
Osaka-shi, Osaka 532  
(81) 6-399-3436

Ryoden Trading Co.,  
Limited<sup>[1,2,3,4]</sup>  
3-15-15, Higashi Ikebukuro,  
Toshima-ku, Tokyo 170  
(81) 3-5396-6206

Ryoyo Electro  
Corporation<sup>[1,2,3,4]</sup>  
Nissin Shokuhin Bldg.  
4-1-1, Nishi-Nakajima  
Yodogawa-ku, Osaka 532  
(81) 6-302-5371

Tokyo Electron Limited<sup>[1,2,3,4]</sup>  
TBS Broadcasting Center,  
5-3-6, Akasaka,  
Minato-Ku, Tokyo 107  
(81) 3-5561-7229

Tokyo Electron Limited<sup>[1,2,3,4]</sup>  
Sumitoseimei Shin-Osaka-  
Kita Bldg.  
4-1-14, Miyahara,  
Yodogawa-ku,  
Osaka-shi, Osaka 532  
(81) 6-399-0260

Yamada Corporation<sup>[1,2,3,4]</sup>  
Shin-Aoyama Bldg. East  
1-1-1 Minami-Aoyama  
Minato-Ku, Tokyo 107  
(81) 3-3475-1121

Yamada Corporation<sup>[1,2,3,4]</sup>  
Nagoya Kokusai-Center  
Bldg.  
1-47-1, Nakono,  
Nakamura-Ku  
Nagoya-shi, Aichi 450  
(81) 52-563-6661

Yamada Corporation<sup>[2,3]</sup>  
Higobashi Shimizu Bldg.  
1-3-7 Tosabori, Nishi-Ku  
Osaka-shi, Osaka 550  
(81) 6-449-1101

**Korea**

Panwest Co. (REP)<sup>[1,2]</sup>  
Songnam Building  
Room 213  
Seocho-dong-Seocho-ku  
1358-6 Seoul  
(82) 2-5547176

SANGSOO Electronics Co.<sup>[2,3]</sup>  
Suite 303 Kyungho Building  
25-2 Yeo euido-Dong  
Youngdeungpo-ku, Seoul  
(82) 2-7805360

**Malaysia**

DCP (M) SDN BHD<sup>[1,2,3,4]</sup>  
6th Floor Wisma Denko  
41 Aboo Sittee Lane  
10400 Penang  
(60) 2281860

ER (Malaysia) Sdn Bhd<sup>[1,2,3,4]</sup>  
6 Jalan SS 26/6 Taman  
Mayang Jaya  
47301 Petaling Jaya  
Selangor Darul Ehsan  
Malaysia  
(603) 703 8498

ER (Malaysia) Sdn Bhd<sup>[1,2,3,4]</sup>  
17L 2nd Floor  
Lebuhraya Batu Lanchang  
Taman Seri Damai  
11600 Penang  
(604) 6562895

**Netherlands**

BFI IBEXSA BV<sup>[2,3]</sup>  
PO Box 3019  
2130 KA Hoofddorp  
(31) 020 65 31 350

EBV ELEKTRONIK<sup>[1,2]</sup>  
Planetenbaan 2  
3606 AK Maarssenbroek  
(31) 3465 623 53

SEI Rodelco B.V.<sup>[1,2]</sup>  
Takkebijsters 2  
4817 BL Breda  
(31) 076 78 4911

**New Zealand**

Avnet VSI (NZ) Ltd<sup>[1,2,3,4]</sup>  
295 Cashel Street  
Christchurch  
(64) 3-3660191

Avnet VSI (NZ) Ltd<sup>[1,2,3,4]</sup>  
1st Floor, Unit 1  
Birchwood Park  
477 Hutt Road  
Lower Hutt  
(64) 4-5273023

Avnet VSI (NZ) Ltd<sup>[1,2,3,4]</sup>  
274 Church Street  
Penrose, Auckland  
(64) 9-6367801

VSI Electronics (NZ)  
Ltd.<sup>[1,2,3]</sup>  
274 Church Street  
Penrose  
Auckland  
(64) 9 636 7801

VSI Electronics (NZ) Ltd.<sup>[1,2]</sup>  
295 Cashel Street  
Christchurch  
(64) 3 660-928

VSI Electronics (NZ) Ltd.<sup>[1,2]</sup>  
Flanders Arcade  
71 High Street  
Lower Hutt  
(64) 4 694-560

**Norway**

Arrow-Tahonic as<sup>[1,2]</sup>  
Box 4554, Toshiow  
0404 Oslo  
+47 2237 8440

Avnet Nortec A/S<sup>[1,2]</sup>  
P.O. Box 123  
N-1364 Hvalstad  
+47 (66) 84 62 10

BFI-IBEXSA Nordic AB<sup>[2,3]</sup>  
Box 7093  
S-191 07 Sollentuna  
Sweden  
+46 (8) 626 99 00

Farnell Electronic Services<sup>[1,2]</sup>  
P.O. Box 120  
N-1001 Oslo  
+47 (22) 32 12 70

**Poland**

SEI elbatex<sup>[1,2]</sup>  
Ul. Wilcza 50/52  
00-697 Warszawa  
(48) 2 623 06 02-609

Macropol Ltd.<sup>[1,2]</sup>  
Ul. Bitwy Warszawskiej 11  
02-366 Warszawa  
(48) 22 224 337

Meditronik<sup>[1,2,3]</sup>  
4, Dzika Street  
00-194 Warsaw  
(48) 2 635 2263

Semicond<sup>[1,2]</sup>  
35, Podchorazych Str.  
0071 Warszawa  
+48 224 145 85

**Puerto Rico**

Hamilton Hallmark  
El Senorail M/S Box 862  
San Juan 00926  
(809) 760-1158

**Russia**

DESAGENT<sup>[1,2]</sup>  
Bodepa Square 2  
19000 St. Petersburg  
(7) 812 196 143

NEKLUSOVA<sup>[1,2]</sup>  
ul Zamshina 15  
St. Petersburg  
(7) 812 545 0723

OPTONIKA<sup>[1,2,3]</sup>  
PO Box 69  
109542 Moscow  
(7) 095 305 7738

RADIS/MTUCI<sup>[2,3]</sup>  
Aviamotornaya 8a  
105855 Moscow  
(7) 095 273 8879

**Singapore**

Dynamar Spore Computer  
Products Pte Ltd<sup>[1,2,3,4]</sup>  
5 Loyang Drive  
Singapore 508936  
(65) 5421878

Hi-Tech Business  
Associates<sup>[1,2,3,4]</sup>  
48 Hillview Terrace  
#05-05 Hillview Building  
Singapore 669269  
(65) 7661995

Ryosho Techno (S) Pte  
Ltd<sup>[1,2,3,4]</sup>  
396 Alexandra Road  
#14-02 BP Tower  
Singapore 119954  
(65) 4737118

Ryoyo Electro Spore Pte  
Ltd<sup>[1,2,3,4]</sup>  
396 Alexandra Road  
#14-02 BP Tower  
Singapore 119954  
2769636

**Slovak Republic**

SEI elbatex<sup>[1,2]</sup>  
Svrca ul. 3  
83259 Bratislava  
(42) 7 722 137

MACRO Components s.r.o.<sup>[1,2]</sup>  
Vysokoskolakov 6  
010-01 Zilina  
(42) 89 45041/34181

**Slovenia**

EBV<sup>[1,2]</sup>  
Diefenbachgasse 35/6  
1150 Vienna  
Austria  
(43) 1 894 1774

IR Electronic<sup>[1,2]</sup>  
Ziherlova ulica 2  
61000 Ljubljana  
(386) 61 222 007

SEI elbatex<sup>[1,2]</sup>  
Stegne 25  
61000 Ljubljana  
(386) 61 195 23 98

**So. Africa**

Advanced Semiconductor  
Devices (PTY) Ltd.<sup>[1,2,3,4]</sup>  
P.O. Box 3853  
SA-2128 Rivonia  
(27) 011 444 23 33

**Spain**

ATD-ARROW  
C/ ALBASANZ 75  
Madrid, 28037  
(34) 1 3041534

BFI IBEXSA<sup>[3]</sup>  
Isabel Colbrand S/N  
Edificio Alpha II Nave 85  
Poligono Industrial Fuencarral  
28049 Madrid  
(34) 1 358 8516

Diode<sup>[1,2]</sup>  
C/ Orense 34  
28020 Madrid  
(34) 1 555 3686

SELCO<sup>[1,2]</sup>  
Sociedad de Electronica y  
Componentes S.A.  
Crts. N-VI, KM 18.2  
Via Servicio, direcc. Villalba  
Las Rozas  
Madrid 28030  
(34) 1 637 1011

**Notes:**

1. Optoelectronics
2. RF Diodes/Transistors
3. Microwave and Avantek Products
4. Fiberoptics Components

**Sweden**

Arrow-TH:s AB<sup>[1,2]</sup>  
Datavagen 12A  
43632 Askim  
+46 316 83 800

Avnet Nortec AB<sup>[1,2]</sup>  
Box 1830  
S-171 27 Solna  
+46 (8) 629 14 00

BFI-IBEXSA Nordic AB<sup>[2,3]</sup>  
Box 7093  
S-191 07 Sollentuna  
+46 (8) 626 99 00

Farnell Electronics  
Services<sup>[1,2]</sup>  
Box 1330  
S-171 26 Solna  
+46 (8) 83 00 20

**Switzerland**

Basix AG<sup>[1,2]</sup>  
Hardturmstr. 181  
Postfach  
8010 Zürich  
(41) 01 276 11 11

BFI IBEXSA Elektronik  
GmbH<sup>[2,3]</sup>  
Korbinianstr. 6  
85386 Eching (München)  
(49) 89 319 51 35

EBV Elektronik AG<sup>[1,2]</sup>  
Vorstadtstrasse 37  
8958 Dietikon  
(41) 1 745 61 61

SEI elbatex<sup>[1,2]</sup>  
Hardstrasse 72  
5430 Wettingen  
(41) 56 275 111

**Taiwan (Republic of China)**

Morrihan International  
Inc.<sup>[1,2]</sup>  
No. 57, 8th Floor  
Yang Shen Shan Yet  
Building  
337 Fu Hsing North Road  
Taipei, Taiwan  
(886) 2 7522200

TECO Enterprise Co., Ltd.  
10F, No. 292, Min-Sheng  
West Road  
Taipei, Taiwan, Republic of  
China  
(886) 2-555976

**Thailand**

DCP Thailand<sup>[1,2,3,4]</sup>  
2991/19 Visuthanee,  
6th Floor Ladprao Road,  
SOI 101-103 Klongchan,  
Bangkapi  
Bangkok 10240  
(66) 2-3760312

ER Thailand<sup>[1,2,3,4]</sup>  
32 Grand Village  
Lardprao Road  
Bangkapi, Bangkok 10310  
(66) 2-9337565

**Turkey**

EMPA AS<sup>[1,2,3]</sup>  
Elektronik Mamulleri  
Pazarlama A.S.  
Florya Is Merkezi  
Besyol Londra Asfalti  
34630 Sefakoy - Istanbul  
(90) 212 599 30 50

**United Kingdom**

Arrow-Jermyn  
St. Martins Business Centre  
Cambridge Road  
Bedford MK42 0LF  
(44) 01234 270 777

Avnet Access Ltd.<sup>[1,2]</sup>  
Jubilee House  
Jubilee Road  
Letchworth  
Herts SG6 1QH  
(44) 01462 48 08 88

BFI IBEXSA Electronics  
Ltd.<sup>[2,3,4]</sup>  
Burnt Ash Road  
Quarry Wood Industrial Estate  
Aylesford  
Kent  
ME20 7NA  
(44) 01622 88 24 67

Farnell Electronic Services<sup>[1,2]</sup>  
Edinburg Way  
Harlow,  
Essex CM20 2DF  
(44) 01279 44 11 44

Farnell Electronic  
Components<sup>[1,2]</sup>  
Canal Road  
Leeds  
West Yorkshire LS12 2TU  
(44) 01132 63 63 11

MACRO Group  
Brunham Lane  
Slough SL1 6LN  
(44) 01628 604 383

---

# Sales & Support

---

**United States/Canada:**  
**1-800-235-0312 or**  
**408-654-8675**

## **Europe**

### **Austria and Eastern Region**

Hewlett-Packard  
In der Luzerben 29  
8902 Urdorf  
Switzerland  
Tel. 0041 735 7940

### **Belgium/Luxemburg**

Hewlett-Packard B.V.  
Startbaan 16  
1187 XR Amstelveen  
Netherlands  
Tel. 0031 20547 7296

### **Finland**

Hewlett-Packard OY  
Piispankalliontie 17  
SF-02200 Espoo  
Tel. 358 08 8721

### **France**

Hewlett-Packard  
Z.A. de Courtaboeuf  
91947 Les Ulis Cedex  
Tel. 0033 1 69 826060

### **Germany**

Hewlett-Packard GmbH  
Hewlett-Packard Str.  
61352 Bad Homburg  
Tel. 0049 6172 161867

### **Greece/Turkey**

Hewlett-Packard S.A.  
150, Route-du Nant-d'Avril  
CH-1217 Meyrin 2  
Tel. 0041 22 780 8111

### **Israel**

Computation & Measurement  
Systems Ltd.  
11 Hashlosa Street  
P.O. Box 25089  
Tel Aviv 67060  
Tel. 0097 23538 0318

### **Italy**

Hewlett-Packard Italiana SpA  
Via G. Di Vittorio 9  
20063 Cernusco S/N (MI)  
Tel. 0039 2 92121

### **Netherlands**

Hewlett-Packard B.V.  
Startbaan 16  
1187 XR Amstelveen  
Tel. 0031 20547 7296

### **Spain/Portugal**

Hewlett-Packard Espanola SA  
Corta de la Coruna km 16500  
Madrid  
28230 Las Rozas  
Tel. 34 1 626 1600

### **Sweden/Denmark/Norway**

Hewlett-Packard AB  
Skalholtsgatan 9, Kista  
Box 19  
164 93 Kista  
Tel. 004687 5020 00

### **Switzerland/South Africa**

Hewlett-Packard  
In der Luzerben 29  
8902 Urdorf  
Tel. 0041 735 7940

### **United Kingdom**

Cain Road Bracknell  
Berkshire RG 12 1HN  
Tel. 0044 1344 362282

### **Far East/Australasia:**

#### **China**

China Hewlett-Packard Co., Ltd.  
Level 5, West Wing Office  
China World Trade Center  
No. 1 Jian Guo Men Wai Ave.  
Beijing, 100 004  
PRC  
Tel. 86-1-505-3888

#### **Korea**

Hewlett-Packard Korea Company  
Components Sales  
25-12, Yoido-dong, Youngdeungpo-ku  
Seoul  
Korea  
Tel. (822) 769-0728

#### **Singapore**

Hewlett-Packard S'pore (Sales) Pte  
Ltd.  
150 Beach Rd.  
#29-00 Gateway West  
Singapore 189720  
Tel. 65-291-9088

#### **Taiwan**

Hewlett-Packard Taiwan Ltd.  
20 Kao Shung Road  
Ping Chen 32404, Tao-Yuan  
Taiwan  
Tel. (886) 3 492-9666

#### **Japan**

**Hewlett-Packard Japan, Ltd.**  
29-21 Takaido-Higashi 3 Chome  
Suginami-Ku, Tokyo 168  
Japan  
Tel. (81)-3-3331-8153

#### **Latin America**

**Argentina/Brazil/Mexico**  
Hewlett-Packard  
Waterford Building, 9th Floor  
5200 Blue Lagoon  
Miami, FL 33126  
Tel. 305-267-4220









HEWLETT®  
PACKARD

Data subject to change.

© Copyright 1996 Hewlett-Packard Co.

Printed in U.S.A. 5965-0987E (4/96)